

EN

IT

SP

FR



## **SMPS - Switching Mode Power Supply (3A) Installation Guide**

For use with RISCO's ProSYS Security Systems

## **Guida All'Installazione Modulo Alimentatore Remoto - SMPS (3A)**

Da utilizzare con le Centrali RISCO serie ProSYS

## **SMPS - Fuente de Alimentación con Módulo de Conmutación (3A) - Guía de Instalación**

Para uso con los Sistemas de Seguridad ProSYS  
de RISCO

## **SMPS - Alimentation en mode commuté (3A) Guide d'Installation**

Pour les systèmes de sécurité ProSYS



## Table of Contents

Introduction.....	4
Main Features .....	4
Mounting the Power Supply.....	6
Power Supply Terminal Wiring .....	8
Relay Output Wiring .....	9
Power Supply Components .....	10
LEDs Indication.....	10
DIP Switches Settings .....	11
Jumper Settings.....	11
Programming the SMPS.....	12
Installer Programming Menu .....	13
User Programming Menu .....	13
Event Log Messages .....	14
Troubleshooting.....	15
Post Installation Tests .....	16
Technical Specifications .....	16
General.....	16
Input.....	16
Output.....	16
Utility Output .....	16
Environmental.....	16
About Wires.....	17
Ordering Part Numbers .....	18

## Introduction

The Switching Mode Power Supply (SMPS) is a reliable, supervised power supply expansion module, for use with RISCO's ProSYS security systems. It provides a total current capacity of up to 3A with extensive remote diagnostics features that comply with EN50131 requirements. It supports a standby battery and is supervised for loss of Mains, Battery, failure of its auxiliary output power and loss of its sounder device.

Up to 8 modules can be added to the system to ensure reliable operation of the system with its multiple devices and accessories.

The SMPS includes two Utility Outputs, which may be separately programmed by the ProSYS as regular utility outputs.

## Main Features

- ◆ 3A switching mode power supply with self supervision
- ◆ Advanced remote diagnostics – includes remote Upload/download or keypad reading of voltage output and current under load
- ◆ Automatic battery protection and remote voltage reading
- ◆ Supports 1.7 Amp Siren, with remote reading of siren current
- ◆ Includes two 3A utility output relays

The SMPS components and jumpers are shown in Figure 1:

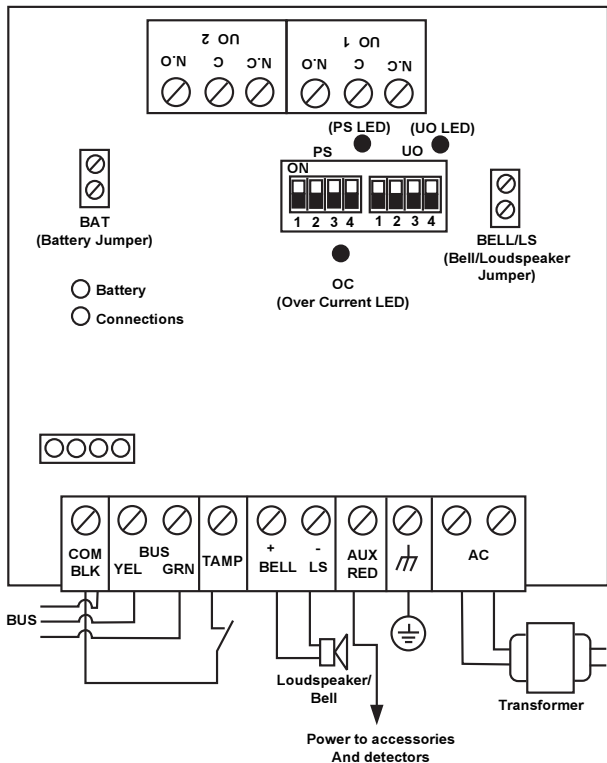

Figure 1: SMPS – General View

## Mounting the Power Supply

Mount the SMPS and the backup battery inside a metal box:



### IMPORTANT:

The SMPS should be serviced by qualified personnel only!  
Unless serviced, the SMPS box must be closed with screws at all times!  
Use only safety-approved wires in accordance with the national rules! (See Table 1: Wire Guide" on page 17).  
The SMPS is designed for indoor use only!

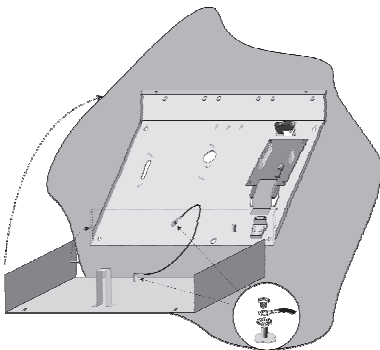

Figure 2: SMPS Inside a Metal Box



### NOTE:

Prior to installation, calculate the total current consumption of the connected devices in order not to exceed the power supply's maximum current consumption!



### IMPORTANT:

To prevent risk of electric shock, disconnect all power sources before servicing!  
Under no circumstances should mains be connected to the PCB other than to the main terminal block!

1. Locate the SMPS metal box in a clean and dry location, close to the mains.
2. Open the SMPS box by releasing the attaching screws.
3. When attaching the box to the wall, it is recommended to use Ø4.2mm, 32mm length screws (DIN 7981 4.2X32 ZP)

- Connect the incoming mains cable to the main fuse terminal block as shown in Figure 3.
- Wire the SMPS terminals as described in "Power Supply Terminal Wiring" on pages 8 - 9.

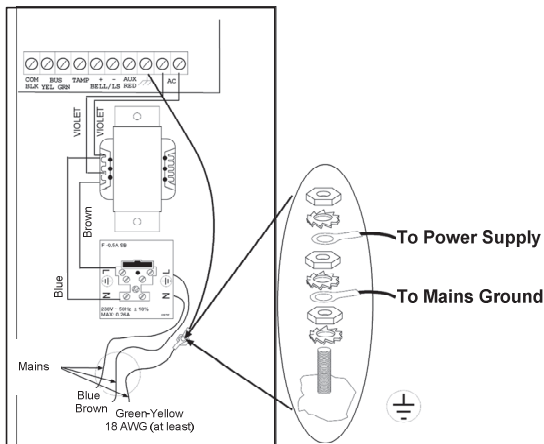

**Figure 3: SMPS – AC & Ground Connection**

- Set the SMPS jumpers and the dipswitches as described in "DIP Switches Settings" on page 11 and section on page 11.
- Locate the battery at the bottom of the SMPS box.
- Connect flying leads (battery connectors) from the SMPS board to the battery terminals - (+) Red, (-) Black).

#### **NOTES:**

- Use only Lead Acid battery type, rated 12V, 7-21AH (maximum) and safety approved in accordance with the national standards!
- The electrical power rating is specified on a label located next to the fuse

#### **Important:**

The main panel should be located near, and easily accessible to an electrical power supply (power outlet).

#### **Important:**

Clamp the AC power cable wires using plastic ties, which must be threaded through the arched tie-down brackets, in order to securely fasten onto the box housing.

9. Switch on the Mains.
10. Perform a BUS test using the ProSYS menu (refer to ProSYS Installation and Programming Manual).
11. Perform a diagnostic test of the SMPS output and battery, using the ProSYS software as described in the User Programming Menu section on page 13.
12. Close the SMPS metal box.

### Power Supply Terminal Wiring

Terminal	Description/Action
COM BLK	BUS terminals: used to connect the SMPS and its Utility Output module to the ProSYS communication Bus. Connect the wires respectively, point to point, according to the indicated colors.
BUS YEL	
BUS GRN	





#### NOTE:

Maximum permitted wire run for Bus wiring from the SMPS to the ProSYS is 300m (1000 ft)!





#### IMPORTANT

**DO NOT** connect the AUX (RED) terminal to the ProSYS BUS. Ensure that the incoming AUX (usually red) wire from the ProSYS Bus is disconnected!

<b>TAMP</b>	Used for connection of the box's tamper switch between the <b>TAMP</b> and the <b>COM</b> terminals (normally closed).
	<b>NOTES:</b> <ol style="list-style-type: none"> <li>1. It is not necessary to use the box tamper if another module sharing the same box is equipped with one.</li> <li>2. To avoid Tamper trouble, if NO connection is made for the TAMP terminal, connect a wire between the TAMP and COM terminals.</li> <li>3. <b>Do not</b> use an End of Line resistor in the tamper switch circuit!</li> </ol>
<b>BELL</b>	Used to connect an external sounder driven by the SMPS (bell or loudspeaker). Position the Bell/LS jumper respectively for the connected device as described in the Jumper Settings section on page 11.
	<b>NOTES:</b> <ol style="list-style-type: none"> <li>1. To avoid bell loop trouble, if NO connection is made for the BELL/LS terminals, connect a 2.2KΩ resistor in its place.</li> <li>2. Use a larger wire gauge if the distance between the sounder and the SMPS is significant. Take the sounder(s) current draw into account when selecting a wire gauge (see About Wires on Page 17).</li> </ol>



<b>AUX RED(+)</b>	Used together with the COM (-) terminal to apply power to Aux. devices (e.g. PIRs, smoke/glass break detectors and any other devices that require 12VDC power supply). Total current consumption from the SMPS (Via The Aux./COM and BELL/LS terminals) is 3A.
	<p><b>NOTE:</b>          If one or more of the AUX/BELL/LS outputs is overloaded and the SMPS shuts down, the SMPS must be reset, using the ProSYS software as follows:</p> <p>From the ProSYS main user menu press  [2] [0] [2] (Overload Restore option), or enter and exit the installation-programming mode (refer to the ProSYS Installation Guide).</p> <p>If overload still exists, perform manual reset as follows:          Disconnect all loads from the AUX/COM terminals for at least 10 seconds before you reconnect any load to the AUX/COM terminals. Then perform Overload Restore again, using ProSYS main user menu (see Installer Programming Menu on page 13).</p>
<b>GROUND (Earth)</b>	Used to connect the GND terminal to the main box ground pin (see illustration on page 6). Use 16 AWG (at least).
<b>AC</b>	Used for connection of the AC terminals (see illustration on page 6) to the transformer outputs (16.5VAC/50 VA).



**NOTE:**

A readily accessible disconnect device shall be incorporated in the building installation wiring.

**Relay Output Wiring**



**NOTE:**

If the SMPS Utility Output is to be used, take into consideration that in such a case one available ProSYS output expander is utilized!

The SMPS Utility Output module comprises two relays (Dry Contacts) that are of the "Change Over" type.

Terminal block description:

**NO** = Normally Open

**NC** = Normally Closed

**C** = Common

Connect each of the SMPS relay outputs according to your preferred configuration.

## Power Supply Components

The LEDs, Dipswitches, jumpers, and terminals functions are described herein.

### LEDs Indication

LED	Description
PS (Power Supply Communication)	Indicates communication status between the Power Supply and the Main Panel.
	<b>On:</b> Normal communication with the Main Panel.
	<b>Off:</b> No input power
	<b>Flashing:</b> Bus communication failure, system in installation mode or PS dipswitch 4 is OFF.
UO (Utility Output Communication)	Indicates communication status between the SMPS UO module and the Main Panel.
	<b>On:</b> Normal communication with the Main Panel.
	<b>Off:</b> No voltage power
	<b>Flashing:</b> Bus communication failure, system in installation mode or UO dipswitch 4 is OFF.
OC (Over Current)	Indicates an actual/potential (calculated) overload.
	<b>On:</b> Total current consumption from the AUX and BELL/LS outputs exceeded 3A (power consumption from both outputs will be disconnected).
	<b>Off:</b> Normal current draw
	<b>Flashing:</b> The SMSP detected a potential current overload when calculating the total value of real current consumption from the AUX output and expected current consumption from the BELL/LS output.
 <b>NOTE:</b>	To calculate sounder's current consumption, the Sounder must be operated at least once (recommended to be performed upon installation completion).

## DIP Switches Settings



Module	Dip Switch	Description
Power Supply	PS/SW1-SW3	Used to set a unique ID number for the Bus module for communication purposes.
	PS/SW4	Enables/Disables Power Supply - ProSYS communication <b>On</b> (up): Communication enabled. <b>Off</b> (down): Communication disabled
Utility output	UO/ SW1-SW3	Used to set a unique Bus ID number for the UO module located on the SMPS board.
	UO/SW4	Enables/disables UO module - ProSYS communication. <b>On</b> (up): communication enabled. <b>Off</b> (down): communication disabled





### NOTE:

When PS/SW4, or UO/SW4 is Off, the ID number defined by SW1-SW3 is not recognized by the ProSYS and can be used for the connection of another accessory of the same category. The UO/PS LED will flash since there is no communication with the main panel.

## Jumper Settings

Jumper	Description
BAT	<b>Battery discharge protection</b>
	 Protection ON If a continuous AC power outage occurs, the SMPS automatically disconnects the battery when its backup battery voltage drops below 10.8VDC. This is done to prevent "deep discharge" that may damage the battery.
	 Protection OFF The battery may be totally discharged during continuous AC failure (no deep discharge protection).
	<b>NOTE:</b> If 2 pins configuration is selected, the battery might be damaged, thus battery replacement may be required.

Jumper	Description	
Bell/LS	Used to determine the SMPS mode of operation in accordance with the sounder device connected to the BELL/LS terminals.	
	 <b>NOTE:</b> The sounder(s) connected to the SMPS operates identically to the main panel's sounder(s).	
	Bell 	For a bell/electronic siren with a built-in siren driver, position jumper on one pin; 12VDC is produced at the sounder's terminals during burglary/panic alarms. Slow pulsing voltage is produced during fire alarm.
	LS (Speaker) 	For a loudspeaker without a built-in siren driver, position jumper on both pins. The SMPS produces continuous oscillating voltage for burglary/panic alarms and an interrupted oscillating voltage for fire alarm.

### Programming the SMPS

The following section describes additional dedicated SMPS software functions added to the ProSYS software.

It is recommended to read and fully understand the ProSYS installation procedure before programming the SMPS!

Up to 8 PS modules may be connected (1.5A regular PS or 3A SMPS).



Up to 8 Utility Output Expansion Modules may be connected to the ProSYS according to the following table:

	ProSYS 16	ProSYS 40	ProSYS 128
Maximum UO Expansion Modules	2	4	8

## Installer Programming Menu

Function	Quick Key	Description
Add/Delete Power Supply Module:	[7] [1] [4]	Selection of new type: <b>PS02</b> , followed by selection of Bell/Speaker (if exists) and assigning to partition.
Add/Delete Utility Output Module:	[7] [1] [3]	New type: <b>UO02</b> A Two-output relay module.

## User Programming Menu

Function	Quick Key	Description
Overload Restore	 [2] [0] [2]	<p><b>NOTE:</b> Performed only if Aux. output is overloaded and then switched off, code is required and the relevant SMPS is selected.</p> <p>The Grand Master/Installer/Sub-installer/Manager can use this option to restore the Aux. power (If overload condition is still present, disconnection of all loads from AUX. output is required!).</p>
View Trouble	 [3] [1]	<p>Trouble messages dedicated to the SMPS:</p> <p><b>Potential overload:</b> The SMSP has detected a potential current overload when calculating the total expected current consumption from the siren and the Aux. outputs.</p> <p><b>Overload:</b> The total current consumption from the Aux. and siren outputs exceed 3A.</p>
Battery	 [4] [CODE] [2]	Tests the standby battery of the pre-selected SMPS. Battery voltage of the relevant SMPS is displayed on the LCD.

Function	Quick Key	Description
<b>SMPS Diagnostics</b>	 [4] [Installer CODE] [#] [9] [2]	<b>Battery Voltage</b> (of pre-selected SMPS); tests battery voltage. <b>Auxiliary load</b> (of relevant SMPS): real time Aux output voltage and current of SMPS. SMPS Aux Output voltage & current are displayed on the LCD keypad. <b>Bell Load</b> (of relevant SMPS); displays the Bell current consumption. The SMPS checks the bell load at each bell operation. The last measured data is displayed on the LCD keypad.

**NOTE:**

The diagnostic features can be also performed from the separately provided Upload/Download software, locally or remotely.

**Event Log Messages**

The following list details SMPS dedicated event messages, as displayed on the keypad LCD:

Event Message	Meaning
S=X OVER. RC=YY	Overload in SMPS X. Reset by user YY
POT.OVRLOAD PS=X	Potential overload of SMPS joined by SMPS ID (1-8)=X
POT.LOAD RS PS=X	Potential overload restore from SMPS, joined by the SMPS ID (1-8)=X
OVERLOAD PS=X	Overload from SMPS joined by the SMPS ID =X
OVERLOAD RS PS=X	Overload restore from SMPS, joined by SMPS ID (1-8)=X
WEAK BAT RS PS=X	Weak Bat indication, joined by the SMPS ID (1-8)=X
WEAK BAT RS PS=X	Weak Bat restore from SMPS joined by SMPS ID (1-8)=X

## Troubleshooting

This section describes possible system problems and their solution. Always perform the following preliminary checks before referring to the troubleshooting table.

Perform a complete visual inspection of the SMPS, its battery, and AC transformer for signs of mechanical damage, loose connections, or torn wires. Check the connections of the incoming AC power source, AC transformer, and battery.

Trouble	Probable Meaning / Cause	Response
<b>AC Failure Trouble</b>	Indicates problem with mains power	Check the mains input and panel box fuse. Replace if necessary with a fuse of the same rating.
<b>Bell Loop Trouble</b>	Indicates that the bell is either faulty or not connected	Check bell/siren wiring. If siren is not used, select the "No Bell/L. speaker" option from the ProSYS menu (see <a href="#">Installer Programming Menu on page 13</a> ).
<b>Low Battery Trouble</b>	No battery, battery is faulty, or needs recharging	Check battery voltage; replace if necessary or wait until battery is recharged.
<b>PS/UO LED Flashing</b>	Communication problem	<ol style="list-style-type: none"> <li>1. Check relevant (PS or UO) dipswitch for correct ID settings and communication enabling.</li> <li>2. Verify appropriate distance of wiring (refer to on page 17).</li> <li>3. Perform Bus test from the ProSYS menu.</li> </ol>
<b>OC LED Flashing</b>	Indicates a potential overload	Disconnect one or more accessories from the AUX. or siren output. Use the <b>ProSYS</b> diagnostics to check system load values (see <a href="#">User Programming Menu on page 13</a> ).
<b>No Output Power from SMPS</b>	Faulty SMPS	View PS troubles using the <b>ProSYS</b> LCD keypad. Check system for shorts. Perform restore to the SMPS (see <a href="#">User Programming Menu on page 13</a> ).

Trouble	Probable Meaning / Cause	Response
System does not function	PS/IO Dipswitch ID has been changed	Reset the SMPS (see User Programming Menu on page 13), disconnect battery and mains wires, wait for few seconds, and reconnect the battery and mains wires.
IO Relays do not operate correctly	Incorrect IO programming	Using the <b>ProSYS</b> menu, verify that the IO functions are appropriately programmed
Bus Test less than 98%	Communication with PS or IO is not stable	The distance between ProSYS and SMPS is too long; verify appropriate distance and gauge of wiring (refer to Table 1: Wire Gauge).

## Post Installation Tests

Upon installation completion, verify that the SMPS is functioning by conducting the "Verify Modules" and Bus Communication tests, from the ProSYS menu.

## Technical

### General

- ◆ Efficiency: 93% @ 1A load, 85 % Min @ 3A full load
- ◆ SMPS card dimensions (HxWxD): 90mm x110mm
- ◆ Weight: 0.14Kg
- ◆ Main Panel Connection: RS485, 3 Wire Bus, up to 300m from Main panel.

### Input

- ◆ Power: 16.5VAC @ 50VA (via 230VAC/16.5VAC/50Hz transformer).
- ◆ Rechargeable Standby Battery: 12V Up To 21 Amp-Hours (AH)
- ◆ Low Battery Threshold: 11V

### Output

- ◆ Auxiliary output: 3A @13VDC
- ◆ Bell/Siren output: 1.7A @13VDC
- ◆ Overload Protection: Automatic Electronic Protection

### Utility Output

- ◆ 12VDC @ 3A max Dry Contact Relays

### Environmental

- ◆ Operating temperature: 0°-55°C



## About Wires

Appropriate use of wires and cables is necessary for the successful installation and operation of the SMPS module. It is important to select wire of the correct thickness to minimize power loss and ensure reliable operation.

Take into account both the current requirements and the wiring distances involved.

**Table 1: Desired Wire Gauge AWG**

Am	32 (0.031mm <sup>2</sup> )		30 (0.049mm <sup>2</sup> )		28 (0.08 mm <sup>2</sup> )		26 (0.13 mm <sup>2</sup> )		24 (0.2 mm <sup>2</sup> )	
	Max Run		Max Run		Max Run		Max Run		Max Run	
	Met.	Feet	Met.	Feet	Met.	Feet	Met.	Feet	Met.	Feet
0.	8.	27.	30	42.	19.	63.	32.8	10	51.4	169
04	4.	13.	12.	21.	9.7	31.	16.4	53.	25.7	84.4
06	2.	9.0	6.4	14.	6.5	21.	10.9	35.	17.1	56.2
08	2.	6.7	4.3	10.	4.8	15.	8.2	26.	12.9	42.2
1	1.	5.4	3.2	8.4	3.9	12.	6.6	21.	10.3	33.7
1.	1.	4.5	2.6	7.0	3.2	10.	5.5	18.	8.6	28.1
1.	1.	3.9	2.1	6.0	2.8	9.1	4.7	15.	7.3	24.1
1.	1.	3.4	1.8	5.3	2.4	8.0	4.1	13.	6.4	21.1
1.	0.	3.0	1.6	4.7	2.2	7.1	3.6	12.	5.7	18.7
2	0.	2.7	1.4	4.2	1.9	6.4	3.3	10.	5.1	16.9
2.	0.	2.5	1.3	3.8	1.8	5.8	3.0	9.8	4.7	15.3
2.	0.	2.2	1.2	3.5	1.6	5.3	2.7	9.0	4.3	14.1
2.	0.	2.1	1.1	3.2	1.5	4.9	2.5	8.3	4.0	13.0
2.	0.	1.9	1.0	3.0	1.4	4.5	2.3	7.7	3.7	12.1
3.	0.	1.8	0.9	2.8	1.3	4.2	2.2	7.2	3.4	11.2

Amp	22 (0.33 mm <sup>2</sup> )		20 (0.5 mm <sup>2</sup> )		18 (0.82 mm <sup>2</sup> )		16 (1.3 mm <sup>2</sup> )		14 (2 mm <sup>2</sup> )	
	Max Run		Max Run		Max Run		Max Run		Max Run	
	Met.	Feet	Met.	Feet	Met.	Feet	Met.	Feet	Met.	Feet
0.	87.	28	132	43	206	67	346	1,13	527	1,7
04	43.	14	66.0	21	103	33	173	568	264	864
06	29.	95	44.0	14	68.5	22	115	379	176	576
08	21.	71	33.0	10	51.4	16	87	284	132	432
1	17.	57	26.4	86.	41.1	13	69	227	105	346
1.	14.	47	22.0	72.	34.2	11	58	189	88	288
1.	12.	40	18.9	61.	29.4	96	50	162	75	247
1.	10.	35	16.5	54.	25.7	84	43	142	66	216
1.	9.7	31	14.7	48.	22.8	75	39	126	59	192
2	8.7	28	13.2	43.	20.5	67	35	114	53	173
2.	7.9	26	12.0	39.	18.7	61	32	103	48	157

2.	7.3	23	11.0	36.	17.1	56	29	95	44	144
2.	6.7	22	10.2	33.	15.8	52	27	87	41	133
2.	6.2	20	9.4	30.	14.7	48	25	81	38	123
3.	5.8	19	8.8	28.	13.7	45	23	76	35	115

Amp	12 (3.3 mm <sup>2</sup> )		10 (5.26 mm <sup>2</sup> )		8 (8 mm <sup>2</sup> )		6 (13.6 mm <sup>2</sup> )		4 (21.73mm <sup>2</sup> )		2 (34.65 mm <sup>2</sup> )	
	Max Run		Max Run		Max Run		Max Run		Max Run		Max Run	
	Met.	Feet	Met.	Feet	Met.	Feet	Met.	Feet	Met.	Feet	Met.	Feet
0.2	833	2,734										
0.4	417	1,367	662	2,171	1,023	3,355						
0.6	278	911	441	1,447	682	2,237	1,00	3,281				
0.8	208	684	331	1,086	511	1,678	750	2,461				
1	167	547	265	868	409	1,342	600	1,969	1,12	3691		
1.2	139	456	221	724	341	1,118	500	1,640	938	3076		
1.4	119	391	189	620	292	959	429	1,406	804	2636		
1.6	104	342	165	543	256	839	375	1,230	703	2307	1,125	3,691
1.8	93	304	147	482	227	746	333	1,094	625	2051	1,000	3,281
2	83	273	132	434	205	671	300	984	563	1845	900	2,953
2.2	76	249	120	395	186	610	273	895	511	1678	818	2,684
2.4	69	228	110	362	171	559	250	820	469	1538	750	2,461
2.6	64	210	102	334	157	516	231	757	433	1420	692	2,271
2.8	60	195	95	310	146	479	214	703	402	1318	643	2,109
3.0	56	182	88	289	136	447	200	656	375	1230	600	1,969

### Ordering Part Numbers

Part Number	Description
RP128EPS000A	SMPS board
RP128PSPSEUA	SMPS + transformer in a metal box
RP128EPSPUKA	SMPS + transformer in a metal box (UK)

## Indice dei Contenuti

Introduzione.....	20
Caratteristiche Principali.....	20
Cablaggio del Modulo Alimentatore.....	22
Collegamento dei Morsetti dell'Alimentatore .....	24
Cablaggio Uscite a Relè.....	26
Componenti del Modulo Alimentatore .....	26
Indicazioni a LED.....	26
Predisposizione Banco Microinterruttori .....	27
Predisposizione Ponticelli.....	28
Programmazione del Modulo Alimentatore.....	29
Menù Programmazione Tecnica della ProSYS .....	29
Menù Programmazione Utente della ProSYS .....	30
Messaggi del Menù Memoria Eventi.....	31
Ricerca Guasti.....	32
Controlli Dopo l'Installazione dell'Alimentatore.....	33
Specifiche Tecniche .....	34
Generali.....	34
Alimentazione d'Ingresso.....	34
Uscite di Alimentazione .....	34
Uscite Programmabili.....	34
Condizioni Ambientali .....	34
Note sui Cavi da Utilizzare .....	34
Prodotti da ordinare.....	36

## Introduzione

L'Alimentatore Remoto SMPS (Switching Mode Power Supply) è un'affidabile e totalmente supervisionato Modulo di Espansione di Alimentazione, da utilizzare con le centrali RISCO serie ProSYS dalla versione SW 3.x e successive.

Esso fornisce una corrente totale di 3A con varie funzioni di diagnostica remota ed è conforme ai requisiti della normativa EN50131-1 ed è certificato IMQ II livello di prestazione. Il Modulo Alimentatore Remoto prevede il collegamento di una batteria di backup ed è supervisionato dalla centrale per Assenza Rete 220V, Basso Livello Batteria, Guasto Uscita di Alimentazione Ausiliaria e Integrità Circuito Sirena.

Il sistema ProSYS, per garantire un funzionamento affidabile con tutti i vari dispositivi e accessori, permette di collegare massimo 8 moduli Alimentatori Remoti.

Il modulo SMPS include due uscite a relè, che possono essere programmate separatamente tramite la ProSYS come normale Modulo Uscite.

## Caratteristiche Principali

- ◆ Modulo Alimentatore Remoto da 3A supervisionato.
- ◆ Diagnostica remota avanzata – lettura tensione d'uscita e carico in corrente sull'alimentatore da software di teleassistenza o da tastiera LCD.
- ◆ Protezione automatica della batteria e lettura remota della tensione sulla batteria.
- ◆ Supporta una Sirena da 1,7Amp. (max.), con lettura remota del carico sull'uscita sirena.
- ◆ Include 2 uscite a relè programmabili.
- ◆ IMQ II Livello di prestazione.

I componenti e i ponticelli del SMPS sono mostrati in Figura 1.

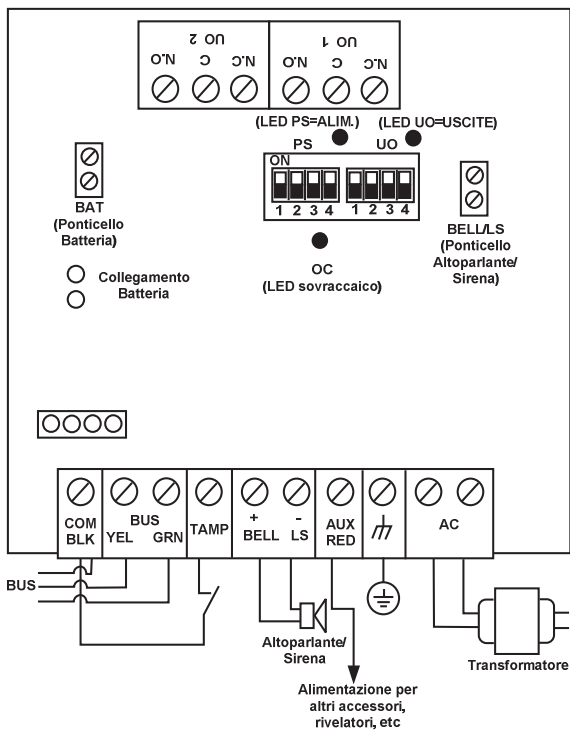

**Figura 1: SMPS - Vista Generale**

## Cablaggio del Modulo Alimentatore

Montare il Modulo SMPS e la batteria in tampone all'interno del contenitore metallico:



### IMPORTANTE:

Gli interventi di manutenzione sul Modulo SMPS devono essere eseguiti SOLO da personale qualificato (installatore).

A meno che non si stia eseguendo una manutenzione, il contenitore del SMPS deve essere SEMPRE chiuso (con le viti).

Utilizzare SOLO cavi conformi alle normative vigenti (Vedi a pagina 35).

Utilizzare SOLO cavi per la rete elettrica conformi alle normative vigenti.

Il sistema è stato progettato per essere utilizzato SOLO da interno.



Figura 2: Modulo SMPS all'interno del Contenitore Metallico



### NOTA:

Prima di procedere all'installazione, calcolare l'assorbimento di corrente totale dei dispositivi collegati, in modo da non superare il massimo assorbimento disponibile dall'Alimentatore!

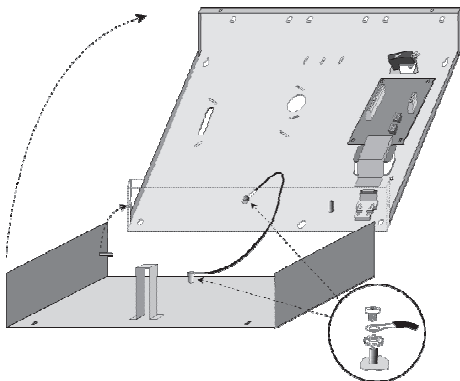

## IMPORTANTE:

Per evitare il rischio di scariche elettriche, scollegare tutte le sorgenti di alimentazione prima di qualsiasi intervento di manutenzione! In nessun caso la tensione proveniente dalla rete elettrica può essere collegata alla centrale in un punto diverso dal blocchetto porta fusibile dedicato a questo tipo di connessione!

1. Posizionare il contenitore del Modulo SMPS in un luogo asciutto e pulito, vicino alla rete elettrica.
2. Aprire il contenitore metallico del Modulo SMPS svitando le viti con un cacciavite.
3. Collegare il cavo della rete elettrica della proprietà al blocchetto porta fusibile dedicato a questo tipo di connessione come mostrato sotto nella Figure 3.
4. Collegare i morsetti del Modulo SMPS come descritto in pagina 24.

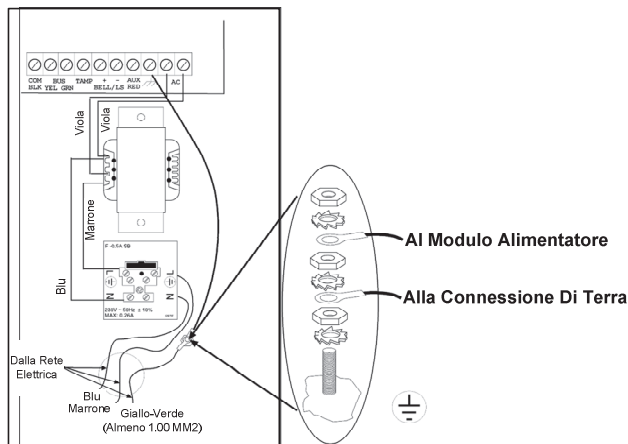

**Figura 3: SMPS - Schema di Cablaggio**

5. Impostare i ponticelli e microinterruttori del modulo SMPS come descritto nella sezione "Predisposizione Banco Microinterruttori" a pagina 27.
6. Posizionare la batteria nella parte in basso del contenitore dell'Alimentatore.

7. Collegare i fili volanti dalla scheda SMPS (collegamenti della batteria) ai morsetti della batteria - Rosso (+), Nero (-).



#### NOTA:

Utilizzare solo batterie di tipo al piombo sigillate, da 12V -, 18 AH (max.)

8. Alimentare da rete elettrica.
9. Effettuare un Test del BUS utilizzando il menù tecnico della ProSYS (Fare riferimento al Manuale di Installazione e Programmazione della ProSYS).
10. Effettuare un test di diagnostica dell'alimentazione ausiliaria e della batteria del Modulo SMPS, utilizzando la tastiera LCD della ProSYS come descritto nella sezione a pagina 30.
11. Chiudere il contenitore metallico del Modulo SMPS.

#### Collegamento dei Morsetti dell'Alimentatore

Morsetto	Descrizione/Azione
COM BLK	Morsetti BUS: utilizzati per collegare il Modulo SMPS e le Uscite integrate, al Bus di comunicazione della ProSYS. Collegare i tre fili rispettando i codici colore BLK (nero), YEL (giallo) e GRN (verde).
BUS YEL	
BUS GRN	



#### IMPORTANTE

**NON** collegare il morsetto AUX (RED) del Modulo Alimentatore con lo stesso morsetto del BUS della ProSYS. Assicurarsi che il filo AUX (solitamente di colore rosso) proveniente dal Bus della ProSYS sia scollegato!





#### NOTA:

Per avere la massima stabilità del sistema è consigliabile **NON** superare la distanza massima di 300 metri dal Modulo SMPS alla ProSYS!

<b>TAMP</b>	Utilizzato per collegare l'interruttore tamper del contenitore tra i morsetti <b>TAMP</b> e <b>COM</b> (normalmente chiuso).
 <b>NOTE</b>	<ol style="list-style-type: none"> <li><b>NON</b> utilizzare la Resistenza di Fine Linea nel circuito dell'interruttore tamper!</li> <li>Per evitare l'anomalia Tamper, se <b>NON</b> viene effettuato il collegamento dell'interruttore tamper, effettuare un cavallotto tra i morsetti <b>TAMP</b> e <b>COM</b>.</li> </ol>
<b>BELL/ LS</b>	Utilizzati per collegare una sirena pilotata dal Modulo SMPS (sirena piezo o altoparlante). Predisporre il ponticello Bell/LS (J1) in funzione del dispositivo collegato come descritto nella sezione a pagina 28.



 <b>NOTE</b>	
<p>Per evitare l'anomalia dell'uscita sirena, Se <b>NON</b> viene effettuato il collegamento dei morsetti BELL/LS, cortocircuitare questi morsetti con una resistenza da 2.2KOhm. Utilizzare un cavo di sezione più grande se la distanza tra la sirena e il modulo SMPS è significativa. Prendere in considerazione l'assorbimento della sirena(e) quando si effettua la scelta della sezione del cavo (vedi a pagina 17)</p>	
<b>AUX RED (+)</b>	<p>Utilizzato insieme al morsetto COM (-) per fornire alimentazione ai dispositivi ausiliari (es. sensori volumetrici, rivelatori di fumo/rottura vetri e qualsiasi altro dispositivo che richiede un'alimentazione 12Vcc). L'assorbimento di corrente totale dal Modulo SMPS (tramite i morsetti AUX/COM e BELL/LS) è di 3A.</p>

 <b>NOTA</b>	
<p>Se una o entrambe delle uscite AUX / BELL/LS sono sovraccaricate, l'Alimentatore interrompe il funzionamento e il Modulo SMPS deve essere resettato utilizzando la tastiera LCD della ProSYS come segue:</p>	
	<p>Dal menù funzioni utente della ProSYS premere <b>[2] [0] [2]</b> (opzione Ripristino Sovraccarico), oppure entrare e uscire dalla modalità di programmazione tecnica (fare riferimento alla Guida Rapida all'Installazione della centrale ProSYS). Se il sovraccarico persiste, effettuare il ripristino manuale come segue: Scollegare tutti i carichi dai morsetti AUX/COM per almeno 10 secondi prima di ricollegare qualsiasi carico a questi morsetti. Poi effettuare di nuovo il Ripristino Sovraccarico, utilizzando il menù delle funzioni utente della ProSYS (vedi "Predisposizione Ponticelli" a pagina 28).</p>
<b>TERRA (Earth)</b>	<p>Utilizzato per collegare il morsetto di terra al punto di messa a terra del contenitore (vedi Figure 3 a pagina 23)</p>
<b>AC</b>	<p>Utilizzati per il collegamento dei fili (solitamente di colore viola) in uscita dal trasformatore (16.5VAC/50 VA) vedi Figure 3 a pagina 23.</p>

**NOTA**

Il modulo SMPS deve essere collegato alla rete elettrica tramite un'interruttore che deve interrompere entrambi i poli e deve essere di tipo magnetotermico e differenziale per proteggere l'impianto da guasti verso terra ed essere facilmente accessibile.

## Cablaggio Uscite a Relè

### NOTA:



Se vengono utilizzate le Uscite a relè del Modulo SMPS, tenere in considerazione che verrà occupata una delle Espansioni Uscite disponibili sulla ProSYS!

Il Modulo Uscite del SMPS include due relè di tipo in scambio (con contatti liberi da tensione).

Descrizione blocchetto morsetti:

NO = Normalmente Aperto

NC = Normalmente Chiuso

C = Comune

Collegare ogni relè del SMPS a seconda della configurazione desiderata.

## Componenti del Modulo Alimentatore

Il funzionamento dei LED, dei Microinterruttori e dei ponticelli del Modulo SMPS è descritto qui di seguito.

### Indicazioni a LED

LED	Descrizione
<b>PS</b> (Comunicazione del Modulo SMPS)	Indica lo stato di comunicazione tra il Modulo SMPS e la centrale ProSYS.
	<b>Acceso:</b> Comunicazione normale con la centrale ProSYS.
	<b>Spento:</b> Assenza alimentazione d'ingresso al Modulo SMPS.
<b>UO</b> (Comunicazione Uscite a Relè)	<b>Lampeggiante:</b> Guasto di comunicazione del Bus, il sistema è in modalità tecnica oppure il microinterruttore SW4 è su OFF.
	Indica lo stato di comunicazione tra le Uscite a Relè del Modulo SMPS e la centrale ProSYS.
	<b>Acceso:</b> Comunicazione normale con la centrale ProSYS.
	<b>Spento:</b> Assenza Alimentazione d'ingresso al Modulo SMPS.
	<b>Lampeggiante:</b> Guasto di comunicazione del Bus, il sistema è in modalità tecnica oppure il microinterruttore SW4 è su OFF.

LED	Descrizione
OC (Sovraccarico)	Indica un sovraccarico reale o potenziale.
	<b>Acceso:</b> Assorbimento di corrente totale dalle uscite di alimentazione AUX e BELL/LS superiore ai 3A (l'alimentazione da entrambe le uscite verrà interrotta).
	<b>Spento:</b> Normale assorbimento di corrente
	<b>Lampeggiante:</b> Il modulo SMPS ha rilevato un sovraccarico di corrente potenziale calcolando l'assorbimento di corrente reale dall'uscita ausiliaria e l'assorbimento di corrente presunto (memorizzato dall'ultima attivazione sirena) dall'uscita BELL/LS.
 <b>NOTA:</b>	Il modulo SMPS controlla continuamente il carico presente sull'uscita ausiliaria. Per calcolare l'assorbimento di corrente della sirena, si raccomanda di effettuare una prova di attivazione della stessa dopo aver completato l'installazione.

### Predisposizione Banco Microinterruttori







Modulo	Microinterruttori	Descrizione
SMPS	PS/ SW1-SW3	Usati per impostare il numero di identificazione ID per il Modulo SMSP.
	PS/ SW4	Abilita/disabilita il Modulo SMPS a comunicare con la ProSYS. <b>On</b> (su): Comunicazione abilitata. <b>Off</b> (giù): Comunicazione disabilitata.
Uscite a Relè	UO/ SW1-SW3	Utilizzati per impostare il numero di identificazione ID per le Uscite a Relè a bordo della scheda SMPS.
	UO/ SW4	Abilita/disabilita le Uscite del Modulo SMPS a comunicare con la ProSYS. <b>On</b> (su): Comunicazione abilitata. <b>Off</b> (giù): Comunicazione disabilitata.



### NOTA:

Se il microinterruttore PS/SW4, o UO/SW4 è su Off, il numero di identificazione ID definito tramite SW1-SW3 non verrà riconosciuto dalla ProSYS. Quindi sarà possibile associare con lo stesso ID definito dall'Alimentatore o dalle uscite integrate, un altro accessorio ProSYS della stessa categoria. Il LED UO/PS lampeggerà indicando che non c'è comunicazione con la centrale ProSYS.

## Predisposizione Ponticelli

Ponticello	Descrizione
<b>BAT</b>	Salvaguardia della Batteria
	 <p>un solo pin (estratto)</p> <p>Se accade una mancanza della rete elettrica, il modulo SMPS scollega automaticamente la batteria quando la tensione sulla batteria va sotto i 10.8 Volt. Questo viene fatto per evitare che la batteria in tampone si possa danneggiare a causa della sua scarica completa.</p>
	 <p>entrambi i pin (inserito)</p> <p>La batteria viene scaricata completamente durante una mancanza della rete elettrica (nessuna protezione sulla scarica completa).</p>
 <p><b>NOTA:</b> Se viene selezionata la configurazione su entrambi i pin, la batteria può essere danneggiata, di conseguenza può essere anche necessario sostituirla.</p>	
<b>BELL/LS</b>	Utilizzati per determinare il modo di funzionamento del Modulo SMPS a seconda del tipo di sirena collegata ai morsetti BELL/LS.
	 <p><b>NOTA:</b> La sirena(e) collegata al Modulo SMPS funziona come la sirena(e) collegata direttamente alla centrale.</p>
	<p><b>BELL</b> (sirena piezo)</p>  <p>Per comandare una sirena piezo che integra il driver, posizionare il ponticello su di un solo pin (estratto); I morsetti BELL/LS erogheranno una tensione di alimentazione 12Vcc costante in caso di allarme panico o intrusione ed una tensione intermittente in caso di allarme incendio.</p>
<p><b>LS</b> (altoparlante)</p>  <p>Per comandare un'altoparlante non provvisto di driver interno, posizionare il ponticello su entrambi i pin (inserito). I morsetti BELL/LS produrranno una tensione modulata continua in caso di allarme panico o intrusione e una tensione modulata intermittente in caso di allarme incendio.</p>	

### Programmazione del Modulo Alimentatore

La seguente sezione descrive le funzioni software dedicate al modulo SMPS che sono state implementate al software della ProSYS già esistente.



Si raccomanda di leggere e capire la procedura di installazione della ProSYS prima di effettuare la programmazione del modulo SMPS! Aggiungendo un modulo SMPS ad un sistema ProSYS esistente, si espande il numero di Uscite di Utilità disponibili e si aggiunge un modulo alimentatore supplementare.

Possono essere collegati fino a 8 Moduli Alimentatori (1.5A o 3A).

### Menù Programmazione Tecnica della ProSYS

Funzione	Tasti rapidi	Descrizione
<b>Agg./Canc. Modulo Alimentatore:</b>	[7] [1] [4]	Scegliere il nuovo tipo di modulo Alimentatore da 3A: PS02, seguito dall'abilitazione dell'uscita sirena Bell/LS (se utilizzata) e dell'assegnazione alla partizione.
<b>Agg./Canc. Modulo Espansione Uscite:</b>	[7] [1] [3]	Nuovo tipo: <b>U002</b> Modulo 2 uscite a relè.

## Menù Programmazione Utente della ProSYS

Funzione	Tasti Rapidi	Descrizione
<b>Ripristino Sovraccarico</b>	 [2] [0] [2]	<p><b>NOTA:</b>                      Questa funzione è da eseguire solo se l'uscita di alimentazione ausiliaria viene sovraccaricata e successivamente viene ripristinata la causa di sovraccarico, è anche richiesto un codice di sistema e di selezionare il modulo SMPS desiderato.</p> <p>I codici Grand Master/ Tecnico/Sub-Tecnico/ Manager possono utilizzare questa funzione per ripristinare l'alimentazione ausiliaria dell'alimentatore (Se la condizione di sovraccarico è ancora presente, è necessario scollegare tutti i carichi dai morsetti di alimentazione ausiliaria!).</p>
<b>Visualizzazione Guasti</b>	 [3] [1]	<p>Messaggi dei guasti dedicati al modulo SMPS:</p> <p><b>Sovraccarico Potenziale:</b> Il modulo SMPS ha rilevato un potenziale sovraccarico di corrente calcolando l'assorbimento totale di corrente presunto dall'uscite sirena e ausiliaria.</p> <p><b>Sovraccarico:</b> L'assorbimento di corrente totale dall'uscita Ausiliaria e dalla sirena è superiore ai 3A.</p>
<b>Test Batteria</b>	 [4] [CODICE] [2]	<p>Test della batteria in tampone del modulo SMPS pre-selezionato. La tensione presente sulla batteria del corrispondente modulo SMPS viene visualizzata sulla tastiera LCD.</p>

Funzione	Tasti Rapidi	Descrizione
<b>Diagnostica Modulo Alimentatore</b>	 [4] [Codice Tecnico] [#][9][2]	<p><b>Tensione Batteria</b> (del modulo SMPS pre-selezionato); test della tensione sulla batteria.</p> <p><b>Carico sull'Uscita Ausiliaria</b> (del corrispondente modulo SMPS): Indicazione reale della tensione e della corrente presente sull'uscita ausiliaria del modulo SMPS. La tensione e la corrente sull'uscita ausiliaria del SMPS vengono visualizzate sulla tastiera LCD.</p> <p><b>Carico su Uscita Sirena</b> (del corrispondente modulo SMPS): viene visualizzato l'assorbimento di corrente sui morsetti BELL/LS. Il modulo SMPS verifica il carico sull'uscita BELL/LS ad ogni attivazione della sirena. Sulla tastiera LCD viene sempre visualizzato l'ultimo valore registrato.</p>



#### NOTA:

La funzione di diagnostica può anche essere effettuata dal software di teleassistenza RISCO, fornito separatamente, localmente o da remoto.

#### Messaggi del Menù Memoria Eventi

La seguente lista descrive i messaggi della memoria eventi dedicati al Modulo Alimentatore Remoto, visualizzati sulla tastiera LCD:

Messaggio Evento	Spiegazione
RS. CAR. AL=X C=YY	Ripristino Sovraccarico di uno specifico modulo SMPS con il codice utente.
SOVRAC. POT. AL=X	Sovraccarico Potenziale di uno specifico modulo SMPS. X= ID (1-8)
RST. CAR. POT. AL=X	Ripristino Sovraccarico potenziale di uno specifico modulo SMPS. X= ID (1-8)
SOVRACCAR. AL=X	Sovraccarico di uno specifico modulo SMPS. X= ID (1-8)
RST. CARICO AL=X	Ripristino Sovraccarico di uno specifico modulo SMPS. X=ID (1-8)
BAT. SCARICA AL=X	Indicazione di Batteria Scarica di uno specifico modulo SMPS. X= ID (1-8)
BATTERIA OK AL=X	Ripristino Batteria di uno specifico modulo SMPS. X= ID (1-8)

## Ricerca Guasti

Questa sezione descrive le possibili anomalie del sistema con le relative soluzioni: utilizzare la tabella seguente per individuare il problema e risolverlo.

Effettuare sempre i seguenti controlli preliminari prima di consultare la ricerca guasti:

Effettuare una completa ispezione visiva sul Modulo Alimentatore, sulla batteria in tampone, e sul trasformatore per scoprire eventuali segni di danneggiamenti meccanici, connessioni allentate, o fili rotti.

Controllare i collegamenti dell'alimentazione di rete in ingresso, del trasformatore e della batteria.

Guasto	Spiegazione	Risposta
<b>Assenza 220V</b>	Indica un problema con l'alimentazione di rete 220 Volt	Controllare l'interruttore della rete elettrica della proprietà ed eventualmente il fusibile di rete all'ingresso del trasformatore posto nel contenitore dell'Alimentatore. Sostituire se necessario il fusibile con uno della stessa capacità.
<b>Anomalia Uscita Sirena</b>	Indica che la sirena interna collegata ai morsetti BELL/LS è guasta o scollegata	Controllare il cablaggio della sirena. Se l'uscita sirena non va usata, selezionare l'opzione "No Uscita Sirena" (vedi <b>Menù Programmazione Utente della ProSYS</b> a pagina 30).
<b>Batteria Scarica</b>	La batteria manca, è guasta o deve essere ricaricata	Controllare la tensione presente ai morsetti della batteria; sostituirla se necessario o attendere che venga ricaricata.
<b>LED PS e/o UO lampeggianti</b>	Problema di Comunicazione	<ol style="list-style-type: none"><li>1. Verificare la corretta impostazione ID del banco di microinterruttori pertinenti (PS=Alim. o UO=Uscite) e l'abilitazione alla comunicazione del modulo.</li><li>2. Verificare che la lunghezza dei cavi sia appropriata (fare riferimento alla pagina 30).</li><li>3. Effettuare il Test del Bus dal menù tecnico della ProSYS.</li></ol>



<b>Guasto</b>	<b>Spiegazione</b>	<b>Risposta</b>
<b>LED OC lampeggiante</b>	Indica un potenziale sovraccarico	Scollegare uno o più accessori dal morsetto AUX o dall'uscita sirena. Si può utilizzare la funzione di diagnostica della ProSYS per verificare i valori di carico del sistema (vedi <b>Menù Programmazione Utente della ProSYS a pagina 30</b> ).
<b>Mancanza Alimentazione Ausiliaria dal Modulo Alimentatore</b>	Anomalia Modulo Alimentatore	Visualizzare i Guasti del Modulo Alimentatore utilizzando la tastiera LCD della <b>ProSYS</b> . Verificare se ci sono cortocircuiti o sovraccarichi. Effettuare la funzione di ripristino dell'alimentazione al Modulo Alimentatore (vedi <b>Menù Programmazione Utente della ProSYS a pagina 30</b> ).
<b>Il sistema non funziona</b>	E' stata modificata l'impostazione ID del banco di microinterruttori PS e/o UO	Resettare il Modulo Alimentatore (vedi <b>Menù Programmazione Utente della ProSYS a pagina 30</b> ), scollegare i fili della batteria e della rete elettrica, attendere qualche secondo e ricollegarli alla batteria e alla rete elettrica.
<b>Le uscite a relè non funzionano correttamente</b>	Le uscite a relè non funzionano correttamente	Utilizzare il menù della <b>ProSYS</b> , verificare che la funzione dell'uscita sia programmata correttamente
<b>Test del Bus inferiore al 98%</b>	La comunicazione con l'Alimentatore (PS) o con le Uscite (UO) non è stabile	Verificare che la lunghezza e la sezione del cavo tra la ProSYS e il Modulo Alimentatore Remoto sia appropriata (fare riferimento alla pagina 35).

### **Controlli Dopo l'Installazione dell'Alimentatore**

Dopo aver completato l'installazione, verificare che il modulo SMPS stia funzionando correttamente effettuando, tramite il menù della ProSYS, la "Verifica Moduli" e il "Test del Bus".

## Specifiche Tecniche

### Generali

- ◆ Efficienza: 93% con 1A di carico, 85 % Min. con 3A di carico
- ◆ Dimensioni Modulo Alimentatore: 90mm x110mm
- ◆ Peso: 0.14Kg
- ◆ Collegamento alla Centrale: BUS RS485 a 3 fili, fino a 300m dalla centrale.

### Alimentazione d'Ingresso

- ◆ Alimentazione: 16.5V ~, 50VA (tramite trasformatore).
- ◆ Batteria Ricaricabile in tampone: 12V — , 18AH max.
- ◆ Bassa Soglia batteria: 11V

### Uscite di Alimentazione

- ◆ Uscita Ausiliaria: 12V - , 3A max.
- ◆ Uscita di alimentazione nominale 13.55V –
- ◆ Assorbimento massimo di corrente 400 mA
- ◆ Uscita Sirena/Altoparlante: 12V — , 1.7A max.
- ◆ Protezione sovraccarico: Fusibili automatici

### Uscite Programmabili

- ◆ 2 Uscite a Relè da 3A max. (contatti in scambio liberi da tensione)

### Condizioni Ambientali

- ◆ Temperatura di funzionamento certificata: da +5° a +40°

## Note sui Cavi da Utilizzare

La scelta e l'utilizzo appropriato dei cavi è fondamentale per la corretta installazione e funzionamento del modulo alimentatore remoto. E' importante scegliere cavi schermati per sistemi d'allarme della giusta sezione per ridurre al minimo le cadute di tensione e garantire l'affidabilità del sistema.

La tabella che segue fornisce utili informazioni riguardo sia l'assorbimento in corrente necessario che della lunghezza massima del cavo richiesta.

Tabella 1: Lunghezza della Linea di Alimentazione calcolata in funzione della sezione del cavo utilizzato e dell'assorbimento in corrente

Tipo di Cavo utilizzato per una specifica ramificazione								
	N x 0.22	N x 0.50	N x 0.75	N x 1.00	N x 1.5	N x 2.00	N x 4.00	N x 8.00
	Lunghezza max.	Lunghezza max.	Lunghezza max.	Lunghezza max.	Lunghezza max.	Lunghezza max.	Lunghezza max.	Lunghezza max.
Amp	in Metri	in Metri	in Metri	in Metri	in Metri	in Metri	in Metri	in Metri
0.2	51.4	87.0	132	206	346	527	833	
0.4	25.7	43.5	66.0	103	173	264	417	1023
0.6	17.1	29.0	44.0	68.5	115	176	278	682
0.8	12.9	21.8	33.0	51.4	87	132	208	511
1	10.3	17.4	26.4	41.1	69	105	167	409
1.2	8.6	14.5	22.0	34.2	58	88	139	341
1.4	7.3	12.4	18.9	29.4	50	75	119	292
1.6	6.4	10.9	16.5	25.7	43	66	104	256
1.8	5.7	9.7	14.7	22.8	39	59	93	227
2	5.1	8.7	13.2	20.5	35	53	83	205
2.2	4.7	7.9	12.0	18.7	32	48	76	186
2.4	4.3	7.3	11.0	17.1	29	44	69	171
2.6	4.0	6.7	10.2	15.8		41	64	157
2.8	3.7	6.2	9.4	14.7		38	60	146
3.0	3.4	5.8	8.8	13.7		35	56	136

**Prodotti da ordinare**

<b>Codice Prodotto</b>	<b>Descrizione</b>
RP128EPS000A	Solo scheda Modulo Alimentatore
RP128PSPSEUA	Modulo Alimentatore + trasformatore in contenitore metallico
RP128PSPSIQA	Modulo Alimentatore + trasformatore in contenitore metallico - certificato IMQ II livello

## Índice

Introducción.....	38
Características Principales .....	38
Montando la Fuente de Alimentación .....	40
Cableado del Terminal de la Fuente de Alimentación .....	42
Cableado de la Salida Relé .....	43
Componentes de la Fuente de Alimentación.....	44
Indicación de los LEDs .....	44
Configuración de los Interruptores Dip .....	45
Configuración de los Puentes.....	45
Programando el SMPS.....	47
Menú de Programación del Instalador.....	47
Menú de Programación del Usuario .....	48
Mensajes de Registro de Eventos .....	49
Solución de Problemas.....	50
Pruebas de Pos-Instalación.....	52
Especificaciones Técnicas .....	52
General.....	52
Entrada .....	52
Salida.....	52
Salida de Utilidad.....	52
Ambiental.....	52
Números de las Partes para Pedidos .....	52
Sobre Cables.....	53

## Introducción

La Fuente de Alimentación con Modo de Conmutación (Switching Mode Power Supply - SMPS) es un módulo confiable, supervisado, de expansión de la fuente de alimentación, para uso con los sistemas de seguridad ProSYS de RISCO.

Provee una capacidad total de corriente de hasta 3A con extensivas características remotas de diagnóstico que atienden a los requerimientos del EN50131. Soporta una batería de reserva y es supervisado para evitar pérdida de Cañerías Maestras, de Batería, de falta de su energía auxiliar de salida y de pérdida de su dispositivo sonoro. Hasta 8 módulos pueden ser añadidos al sistema para asegurar la operación confiable del sistema con sus múltiples dispositivos y accesorios.

El SMPS incluye dos Salidas de Utilidad, que pueden ser programadas por separado por el ProSYS como salidas regulares de utilidad.

## Características

- ◆ Fuente de Alimentación con modo de conmutación 3A con auto-supervisión
- ◆ Diagnóstico remoto avanzado - incluye remoto Upload /Download o lectura en el teclado de la salida de voltaje y de la corriente de carga
- ◆ Protección automática de la batería y lectura remota del voltaje
- ◆ Soporta una sirena de 1.7 Amp, con lectura remota de la corriente de la sirena
- ◆ Incluye dos salidas de utilidad de relé 3A

Los componentes y puentes del SMPS son presentados en la Figure 1:



Figura 4: SMPS – Vista General

## Montando

Monte el SMPS y la batería de reserva dentro de una caja de metal:

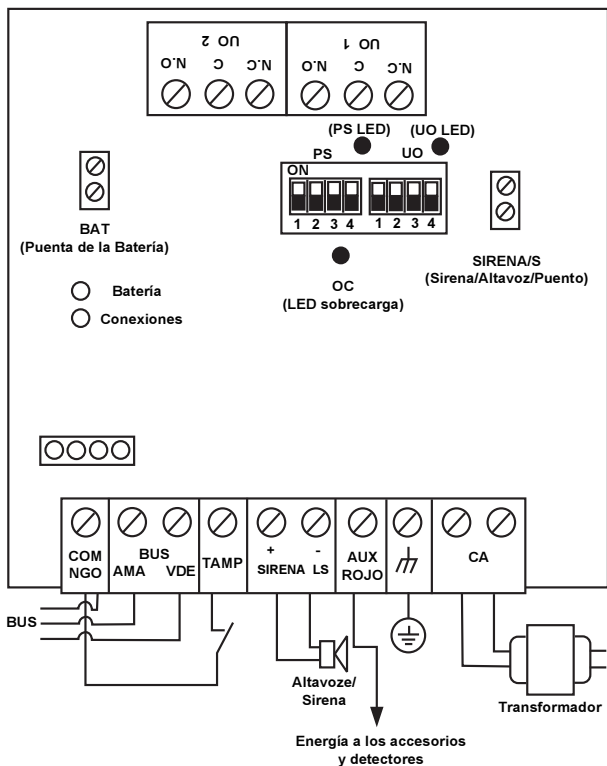

### IMPORTANTE

¡El SMPS debe ser mantenido solamente por personal calificado!  
¡A menos que esté en manutención, la caja del SMPS debe estar siempre cerrada con los tornillos!  
¡Utilice solamente alambres aprobados por seguridad según las reglas nacionales! (Véase Tabla 1: Guía de Alambres" en la página 53).  
El SMPS es proyectado solamente para uso en el interior!



Figura 5: SMPS Dentro de una Caja de Metal



### NOTA:

¡Antes de la instalación calcule el consumo total de corriente de los dispositivos conectados a fin de no exceder el máximo consumo de corriente de la fuente de alimentación!

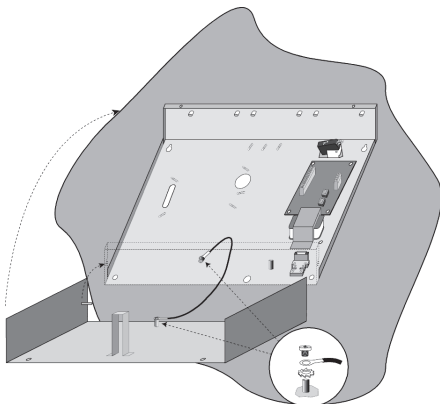

### IMPORTANTE

¡Para evitar riesgo de descarga eléctrica, desconecte todas las fuentes de energía antes de la manutención! ¡Bajo ninguna circunstancia deberán las cañerías estar conectadas al PCB con excepción al bloque principal de terminales!

1. Ubique la caja de metal del SMPS en un lugar seco y limpio, cerca de las cañerías maestras.





10. Realice una prueba del BUS usando el menú del ProSYS (refiérase al Manual de Instalación y Programación del ProSYS).
11. Realice una prueba de diagnóstico de la salida del SMPS y de la batería, usando el software del ProSYS como descrito en la sección Menú de Programación del Usuario en la página 48.
12. Cierre la caja de metal del SMPS.

## Cableado

Terminal	Descripción / Acción
COM NGO	Terminales del BUS: usados para conectar el SMPS y su módulo de Salida de Utilidad al Bus de comunicación del ProSYS. Conecte los cables respectivamente, punto a punto, según los colores indicados.
BUS AMA	
BUS VDE	



### NOTA:

La máxima extensión de cable permitida para cableado del Bus desde el SMPS al ProSYS es de 300m (1000 pies)!



### IMPORTANTE:

**NO** conecte el terminal AUX (ROJO) al BUS del ProSYS. ¡Asegúrese de que el cable AUX de entrada (normalmente rojo) del Bus del ProSYS esté desconectado!

TAMP	Usado para la conexión del interruptor tamper de la caja entre el TAMP y los terminales COM (normalmente cerrado).
------	--



### NOTAS:



1. No es necesario usar el tamper de la caja si otro módulo que comparte la misma caja esté equipado con uno.
2. Para evitar problema con el Tamper, si no se hace NINGUNA conexión para el terminal TAMP, conecte un cable entre los terminales TAMP y COM.
3. **No** use un resistor Fin de Línea en el circuito de conmutación del tamper!

SIRENA/ LS	Usado para conectar un dispositivo sonoro externo guiado por el SMPS (sirena o altavoz). Coloque el puente Sirena/LS respectivamente para el dispositivo conectado como descrito en la sección Configuración de los Puentes en la página 45
------------	---



### NOTAS:

1. Para evitar problema de bucle de sirena, si NO se hace ninguna conexión para los terminales SIRENA/LS, conecte un resistor 2.2KΩ en su lugar.
2. Use un cable de calibre más ancho si la distancia entre el dispositivo sonoro y el SMPS es significativa. Tome en consideración el consumo de corriente del dispositivo sonoro(s) al seleccionar el calibre del cable (Véase

Terminal	Descripción / Acción
Tabla 1: Guía de Alambres" en la página 53).	
<b>AUX ROJO (+)</b>	Usado juntamente con el terminal COM (-) para aplicar energía a los dispositivos Aux. (por ejemplo, PIRs, detectores de humo /rotura de cristal y cualquier otro dispositivo que requiera alimentación de energía 12VDC). El consumo total de corriente del SMPS (Vía los terminales Aux./COM y SIRENA/LS) es 3A.
 <b>NOTA:</b> Si una o más de las salidas AUX/SIRENA/LS está sobrecargada y el SMPS se cierra, el SMPS debe ser reajustado, usándose el software del ProSYS como sigue:  Del menú principal del usuario del ProSYS presione  [2] [0] [2] (opción Restaurar Sobrecarga), o entre y salga del modo de instalación-programación (refiérase al Guía de Instalación del ProSYS). Si todavía hay sobrecarga, realice un reajuste manual como sigue: Desconecte todas las cargas de los terminales AUX/COM durante por lo mínimo 10 segundos antes de reconectar cualquier carga a los terminales AUX/COM. Después ejecute Restaurar Sobrecarga otra vez, usando el menú principal del usuario del ProSYS (véase "Menú de Programación del Usuario" en la página 48).	
<b>TIERRA (suelo)</b>	Usado para conectar el terminal GND al perno suelo de la caja principal (véase ilustración en la página 6). Use 16 AWG (por lo menos).
<b>AC</b>	Usado para la conexión de los terminales CA (véase ilustración en la página 41) a las salidas del transformador (16.5VAC/50 VA).

**NOTA:**

Un dispositivo de desconexión fácilmente accesible será incorporado en la instalación del cableado del edificio.

## Cableado

**NOTA:**

¡Si la Salida de Utilidad del SMPS debe ser usada, tome en consideración que en tal caso se utiliza un amplificador de salida disponible del ProSYS!

El módulo Salida de Utilidad del SMPS comprende dos relés (Contactos Secos) que son del tipo "Change Over".

Descripción del bloque de terminal:

**NO** = Normalmente Abierto

**NC** = Normalmente Cerrado

**C** = Común

Conecte cada una de las salidas de relé del SMPS según su configuración preferida.

## Componentes

Las funciones de los LEDs, de los Interruptores Dip, de los puentes, y de los terminales son descritas a seguir.

### Indicación de los LEDs

LED	Descripción
<b>PS</b> (Comunicación de la Fuente de Alimentación)	Indica el estatus de la comunicación entre la Fuente de Alimentación y el Panel Principal.
	<b>Encendido:</b> Comunicación normal con el Panel Principal.
	<b>Apagado:</b> No hay energía de entrada.
	<b>Parpadeo:</b> Falla en la comunicación del Bus, sistema en modo de instalación o el interruptor Dip PS 4 está desconectado (OFF).
<b>SU</b> (Comunicación de la Salida de Utilidad)	Indica el estatus de la comunicación entre el módulo SU del SMPS y el Panel Principal.
	<b>Encendido:</b> Comunicación normal con el Panel Principal.
	<b>Apagado:</b> No hay energía de voltaje
	<b>Parpadeo:</b> Falla en la comunicación del Bus, sistema en modo de instalación o el interruptor Dip SU 4 está desconectado (OFF).
<b>OC</b> (Sobrecarga de la Corriente)	Indica una sobrecarga actual / potencial (calculada).
	<b>Encendido:</b> El consumo total de corriente de las salidas AUX y SIRENA/LS excederán 3A (el consumo de energía de ambas salidas será desconectado).
	<b>Apagado:</b> Consumo normal de corriente
	<b>Parpadeo:</b> El SMPS detectó una sobrecarga potencial de corriente al calcular el valor total del consumo actual de corriente de la salida AUX. y el consumo de corriente previsto de la salida SIRENA/LS.
 <b>NOTA</b> Para calcular el consumo de corriente del dispositivo sonoro, el Dispositivo Sonoro debe ser operado por lo menos una vez (se recomienda ser realizado al completarse la instalación).	

## Configuración de los Interruptores Dip



Módulo	Interruptor Dip	Descripción
Aliment. Energía	PS/SW1-SW3	Usado para configurar un número de ID único para el módulo Bus para fines de comunicación.
	PS/SW4	Habilita / deshabilita la comunicación entre la Alimentación de Energía – ProSYS <b>Encendido</b> (para arriba): Comunicación habilitada. <b>Apagado</b> (para abajo): Comunicación deshabilitada
SalidaUtilid.	SU/ SW1-SW3	Usado para configurar un número de ID único para el módulo SU ubicado en el tablero del SMPS.
	SU/SW4	Habilita / deshabilita la comunicación entre el módulo SU – ProSYS. <b>Encendido</b> (para arriba): Comunicación habilitada. <b>Apagado</b> (para abajo): Comunicación deshabilitada







### NOTA:

Cuando el PS/SW4, o UO/SW4 están Apagados (Off), el número de ID definido por SW1-SW3 no es reconocido por el ProSYS y puede ser usado para la conexión de otro accesorio de la misma categoría. El LED UO/PS parpadeará visto que no hay comunicación con el panel principal.

## Configuración de los Puentes

Puentes	Descripción	
BAT	Protección de descarga de la batería	
	 Protección ON	Si ocurre una interrupción continua de la energía CA, el SMPS desconecta automáticamente la batería cuando el voltaje de la batería baja a menos de 10.8VDC. Esto se hace para evitar “descarga profunda” lo que podría dañar la batería.
	 Protección OFF	La batería puede ser totalmente descargada durante una interrupción continua de la energía CA (sin protección contra descarga profunda).

Puentes	Descripción	
	 <p><b>NOTA:</b> Si la configuración de 2 pernos es seleccionada, la batería podrá ser damnificada, y puede ser necesario su reemplazo.</p>	
<b>Sirena</b>	<p>Usado para determinar el modo de operación del SMPS según el dispositivo sonoro conectado a los terminales SIRENA/LS.</p>  <p><b>NOTA:</b> El dispositivo(s) sonoro(s) conectado al SMPS opera idénticamente al dispositivo(s) sonoro(s) del panel principal.</p>	
	<p>Sirena</p> 	<p>Para una campana / sirena electrónica con un conductor de sirena empotrado, posicione el puente en un perno; 12VDC es producido en los terminales del dispositivo sonoro durante alarmas de robo / pánico. Un voltaje de pulsación lenta es producido durante una alarma de incendio.</p>
	<p>LS (Altavoz)</p> 	<p>Para un altavoz sin un conductor de sirena empotrado, posicione el Puente en ambos pernos. El SMPS produce un voltaje continuo oscilante para alarmas de robo / pánico y un voltaje oscilante interrumpido para alarmas de incendio.</p>

## Programando

La sección siguiente describe las funciones adicionales dedicadas del software del SMPS agregadas al software del ProSYS. ¡Se recomienda leer y entender completamente el procedimiento de instalación del ProSYS antes de programar el SMPS!

Hasta 8 módulos de PS pueden ser conectados (1.5A regular PS o 3A SMPS).

Hasta 8 Módulos de Expansión de Salidas de Utilidad pueden ser conectados al ProSYS según la siguiente tabla:

	ProSYS 16	ProSYS 40	ProSYS 128
Máximo Número de Módulos de Expansión de SU	2	4	8

## Menú de Programación del Instalador

Función	Tecla Rápida	Descripción
<b>Agregar/Borrar Módulo de Alimentación de Energía</b>	[7] [1] [4]	Selección del nuevo tipo: PS02, seguido por la selección de Sirena / Parlante (si existe) y la asignación de partición.
<b>Agregar/Borrar Módulo de Salida de Utilidad</b>	[7] [1] [3]	Nuevo tipo: UO02  Un módulo de 2-salidas relé.

## Menú de Programación del Usuario

Función	Tecla Rápida	Descripción
<b>Restaurar Sobrecarga</b>	* [2] [0] [2]	<p><b>NOTA:</b> Realizado solamente si la salida Aux. estuviera sobrecargada y después desconectada, el código es requerido y el relevante SMPS es seleccionado.</p> <p>El Grand Master/Instalador/Sub-Instalador/Manager puede usar esta opción para restaurar la energía Aux. (¡Si la condición de sobrecarga está todavía presente, la desconexión de todas las cargas de la salida AUX. es requerida!).</p>
<b>Visualización de Problemas</b>	* [3] [1]	<p>Mensajes de problemas dedicados al SMPS:</p> <p><b>Sobrecarga potencial:</b> El SMPS ha detectado una sobrecarga potencial de corriente al calcular el esperado consumo de corriente de la sirena y de las salidas Aux.</p> <p><b>Sobrecarga:</b> El consumo total de corriente de las salidas Aux. y sirena exceden 3A.</p>
<b>Prueba de la Batería</b>	* [4] [CÓDIGO] [2]	<p>Prueba la batería de reserva del SMPS pre-seleccionado. El voltaje de la batería del relevante SMPS es presentado en el teclado numérico del LCD.</p>
<b>SMPS Diagnóstico</b>	* [4] [CÓDIGO del Instalador] [#][9][2]	<p><b>Voltaje de la Batería</b> (del pre-seleccionado SMPS); pruebas de voltaje de la batería.</p> <p><b>Carga auxiliar</b> (del relevante SMPS): Voltaje y corriente de la salida Aux del SMPS en tiempo real. El voltaje y la corriente de la Salida Aux del SMPS es presentado en el teclado numérico del LCD.</p> <p><b>Carga de la Sirena</b> (del relevante SMPS); presenta el consumo de corriente de la Sirena. El SMPS verifica la carga de la sirena a cada operación de la sirena. Los últimos datos medidos son presentados en el teclado numérico del LCD.</p>



**NOTA:**

Las características de diagnóstico pueden también ser ejecutadas local o remotamente, a partir del software Upload/Download proveído separadamente.

**Mensajes**

La siguiente lista detalla los mensajes de eventos dedicados del SMPS, como presentados en el teclado numérico LCD:

<b>Mensaje de Evento</b>	<b>Significado</b>
S=X OVER. RC=YY	Sobrecarga en el SMPS X. Restablecido por el usuario YY
POT.OVRLOAD PS=X	Sobrecarga potencial del SMPS añadida por el SMPS ID (1-8)=X
POT.CARG RS PS=X	Restauración de la sobrecarga potencial del SMPS, añadida por el SMPS ID (1-8)=X
OVERLOAD PS=X	Sobrecarga del SMPS añadida por el SMPS ID =X
OVERLOAD RS PS=X	Restauración de la sobrecarga del SMPS, añadida por el SMPS ID (1-8)=X
BAT DEB RS PS=X	Indicación de Batería Débil, añadida por el SMPS ID (1-8)=X
BAT DEB RS PS=X	Restauración de Batería Débil del SMPS añadida por el SMPS ID (1-8)=X

## Solución de Problemas

Esta sección describe los posibles problemas del sistema y su solución. Realice siempre los siguientes chequeos preliminares antes de referirse a la tabla de solución de problemas. Realice una inspección visual completa del SMPS, su batería, y el transformador CA para señales de daño mecánico, conexiones perdidas o cables rotos. Verifique las conexiones de la fuente de energía de entrada, del transformador CA, y de la batería.

Problema	Probable Significado/ Causa	Respuesta
<b>Problema de Falla CA</b>	Indica problema con la cañería maestra	Verifique la entrada de la cañería maestra y la caja de fusible del panel. Reemplace si necesario con un fusible de la misma categoría
<b>Problema de Bucle de la Sirena</b>	Indica que la sirena está con defecto o no está conectada	Verifique el cableado de la campana /sirena. Si la sirena no es usada, seleccione la opción "Sin Sirena / Altavoz" del menú del ProSYS (véase el Menú de Programación del Usuario en la página 48).
<b>Problema de Batería Débil</b>	No hay batería o la batería está defectuosa, o necesita ser recargada	Verifique el voltaje de la batería; reemplace si necesario o espere hasta que la batería sea recargada.
<b>Parpadeo del LED PS/SU</b>	Problema de comunicación	<ol style="list-style-type: none"> <li>1. Verifique el relevante interruptor Dip (PS o SU) para una correcta configuración del ID y para habilitar la comunicación.</li> <li>2. Verifique la distancia apropiada del cableado.</li> <li>3. Ejecute la prueba del Bus desde el menú del ProSYS.</li> </ol>
<b>Parpadeo del LED OC</b>	Indica una sobrecarga potencial	Desconecte uno o más accesorios de la salida AUX. o de la sirena. Use los diagnósticos del ProSYS para verificar los valores de carga del sistema (véase el Menú de Programación del Usuario en la página 48).

<b>Problema</b>	<b>Probable Significado/ Causa</b>	<b>Respuesta</b>
<b>No hay Energía de Salida desde el SMPS</b>	SMPS defectuoso	Vea los problemas de PS usando el teclado numérico LED del ProSYS. Verifique el sistema para cortocircuitos. Ejecute restauración al SMPS (véase Menú de Programación del Usuario en la página 48).
<b>Sistema no funciona</b>	El ID del Interruptor DIP PS/SU ha sido cambiado	Restablezca el SMPS (véase el Menú de Programación del Usuario en la página 48), desconecte la batería y los cables principales, espere algunos segundos y reconecte la batería y los cables principales.
<b>Relés de SU no funcionan correctamente</b>	Programación incorrecta de la SU	Usando el menú del ProSYS, verifique que las funciones de la SU están programadas apropiadamente.
<b>Prueba del Bus inferior a 98%</b>	Comunicación con la PS o SU no es estable	La distancia entre el ProSYS y el SMPS es demasiado larga; verifique la distancia y calibre apropiados del cableado (refiérase a la Tabla 1: Calibre del Cable).

## Pruebas de Pos-Instalación

Después de completada la instalación, verifique que el SMPS esté funcionando realizando las pruebas de "Verificar Módulos" y Comunicación del Bus, desde el menú del ProSYS.

### Especificaciones Técnicas

#### General

- ◆ Rendimiento: 93% @ 1A carga, 85 % Min @ 3A carga completa
- ◆ Dimensiones de la tarjeta SMPS (AlxAnxP): 90mm x110mm
- ◆ Peso: 0.14Kg
- ◆ Conexión del Panel Principal: RS485, Bus 3 Cables, hasta 300m del Panel Principal.

#### Entrada

- ◆ Energía: 16.5VAC @ 50VA (vía transformador 230VAC/16.5VAC/50Hz).
- ◆ Batería de Reserva Recargable: 12V Hasta 21 Amp-Horas (AH)
- ◆ Bajo Umbral de la batería: 11V

#### Salida

- ◆ Salida auxiliar: 3A @13VDC
- ◆ Salida Campana / Sirena: 1.7A @13VDC
- ◆ Protección contra Sobrecarga: Protección Electrónica Automática

#### Salida de Utilidad

- ◆ 12VDC @ 3A máx Relés Contacto Seco

#### Ambiental

- ◆ Temperatura de Operación: 0°-55°C

### Números

Parte Número	Descripción
RP128EPS000A	Tablero del SMPS
RP128PSPSEUA	SMPS + transformador en una caja de metal

## Sobre Cables

El uso del cable apropiado es necesario para la correcta instalación y funcionamiento del módulo SMPS. Es importante seleccionar un cable del grosor correcto para reducir al mínimo la pérdida de alimentación y para asegurar un funcionamiento adecuado. Tenga en cuenta los requisitos de corriente y la distancia del cableado implicado.

Tabla 1: Sección del cable AWG

Amp	32 (0.031mm <sup>2</sup> )		30 (0.049mm <sup>2</sup> )		28 (0.08 mm <sup>2</sup> )		26 (0.13 mm <sup>2</sup> )		24 (0.2 mm <sup>2</sup> )	
	Máx Ext.		Máx Ext		Máx Ext		Máx Ext		Máx Ext	
	Met.	Pies	Met.	Pies	Met.	Pies	Met.	Pies	Met.	Pies
0.	8.2	27.	30	42.	19.	63.	32.	108	51.	169
04	4.1	13.	12.	21.	9.7	31.	16.	53.	25.	84.
06	2.7	9.0	6.4	14.	6.5	21.	10.	35.	17.	56.
08	2.1	6.7	4.3	10.	4.8	15.	8.2	26.	12.	42.
1	1.6	5.4	3.2	8.4	3.9	12.	6.6	21.	10.	33.
1.	1.4	4.5	2.6	7.0	3.2	10.	5.5	18.	8.6	28.
1.	1.2	3.9	2.1	6.0	2.8	9.1	4.7	15.	7.3	24.
1.	1.0	3.4	1.8	5.3	2.4	8.0	4.1	13.	6.4	21.
1.	0.9	3.0	1.6	4.7	2.2	7.1	3.6	12.	5.7	18.
2	0.8	2.7	1.4	4.2	1.9	6.4	3.3	10.	5.1	16.
2.	0.7	2.5	1.3	3.8	1.8	5.8	3.0	9.8	4.7	15.
2.	0.7	2.2	1.2	3.5	1.6	5.3	2.7	9.0	4.3	14.
2.	0.6	2.1	1.1	3.2	1.5	4.9	2.5	8.3	4.0	13.
2.	0.6	1.9	1.0	3.0	1.4	4.5	2.3	7.7	3.7	12.
3.	0.5	1.8	0.9	2.8	1.3	4.2	2.2	7.2	3.4	11.

Amp	22 (0.33 mm <sup>2</sup> )		20 (0.5 mm <sup>2</sup> )		18 (0.82 mm <sup>2</sup> )		16 (1.3 mm <sup>2</sup> )		14 (2 mm <sup>2</sup> )	
	Máx Ext		Máx Ext		Máx Ext		Máx Ext		Máx Ext	
	Met.	Pies	Met.	Pies	Met.	Pies	Met.	Pies	Met.	Pies
0.2	87.	285	132	433	206	674	346	1,13	527	1,7
04	43.	142	66.	217	103	337	173	568	264	864
06	29.	95.	44.	144	68.	225	115	379	176	576
08	21.	71.	33.	108	51.	169	87	284	132	432
1	17.	57.	26.	86.6	41.	135	69	227	105	346
1.2	14.	47.	22.	72.2	34.	112	58	189	88	288
1.4	12.	40.	18.	61.9	29.	96	50	162	75	247
1.6	10.	35.	16.	54.1	25.	84	43	142	66	216
1.8	9.7	31.	14.	48.1	22.	75	39	126	59	192

2	8.7	28.	13.	43.3	20.	67	35	114	53	173
2.2	7.9	26.	12.	39.4	18.	61	32	103	48	157
2.4	7.3	23.	11.	36.1	17.	56	29	95	44	144
2.6	6.7	22.	10.	33.3	15.	52	27	87	41	133
2.8	6.2	20.	9.4	30.9	14.	48	25	81	38	123
3.0	5.8	19	8.8	28.9	13.	45	23	76	35	115

	12 (3.3 mm <sup>2</sup> )		10 (5.26 mm <sup>2</sup> )		8 (8 mm <sup>2</sup> )		6 (13.6 mm <sup>2</sup> )		4 (21.73mm <sup>2</sup> )		2 (34.65 mm <sup>2</sup> )	
	Máx Ext		Máx Ext		Máx Ext		Máx Ext		Máx Ext		Máx Ext	
Amp	Met.	Pies	Pies	Pies	Met.	Pies	Met.	Pies	Met.	Pies	Met.	Pies
0.2	833	2,734										
04	417	1,367	662	2,171	1,023	3,355						
06	278	911	441	1,447	682	2,237	1,00	3,281				
08	208	684	331	1,086	511	1,678	750	2,461				
1	167	547	265	868	409	1,342	600	1,969	1,125	3691		
1.2	139	456	221	724	341	1,118	500	1,640	938	3076		
1.4	119	391	189	620	292	959	429	1,406	804	2636		
1.6	104	342	165	543	256	839	375	1,230	703	2307	1,12	3,69
1.8	93	304	147	482	227	746	333	1,094	625	2051	1,00	3,28
2	83	273	132	434	205	671	300	984	563	1845	900	2,95
2.2	76	249	120	395	186	610	273	895	511	1678	818	2,68
2.4	69	228	110	362	171	559	250	820	469	1538	750	2,46
2.6	64	210	102	334	157	516	231	757	433	1420	692	2,27
2.8	60	195	95	310	146	479	214	703	402	1318	643	2,10
3.0	56	182	88	289	136	447	200	656	375	1230	600	1,96

## Contents

Introduction.....	56
Caractéristiques principales .....	56
Installation du module d'alimentation.....	58
Câblage des Bornes de Connexion .....	60
Câblage de la sortie relais .....	62
Eléments de l'alimentation électrique .....	62
Indications de la diode électroluminescente LED .....	63
Réglages des micro-interrupteurs DIP .....	64
Réglages des cavaliers.....	65
Programmation du SMPS.....	66
Menu de Programmation Installateur.....	66
Menu de Programmation Utilisateur .....	67
Messages du Journal .....	68
Localisation des pannes.....	69
Tests à effectuer après l'installation .....	71
Spécifications techniques .....	71
Généralités .....	71
Entrée .....	71
Sortie .....	71
Sortie Programmable.....	71
Spécifications environnementales .....	71
Fils électriques .....	72
Codes catalogue .....	74

## Introduction

Le module d'alimentation en mode commuté (SMPS) est un transformateur électrique de surveillance fiable, applicable aux systèmes de sécurité ProSYS.

Il fournit une capacité totale de courant allant jusqu'à 3A et présente des caractéristiques de diagnostic à distance conformes aux exigences EN50131. Equipé d'une batterie de réserve, il reste sous contrôle en cas de coupure de courant, de batterie faible, de panne de sa sortie programmable et de perte de sa sirène.

Jusqu'à 8 modules peuvent être intégrés au système tout en lui garantissant un fonctionnement fiable avec ses divers appareils et accessoires.

Le SMPS comprend deux sorties qui peuvent être programmées séparément par le système comme des sorties utilitaires ordinaires.

## Caractéristiques principales

- ◆ Alimentation électrique de surveillance automatique à commutation de 3A.
- ◆ Diagnostic à distance de technologie avancée – comprenant le téléchargement/télétransmission à distance ou la lecture au clavier de la tension et du courant de charge,
- ◆ Protection automatique de la batterie et lecture de tension à distance,
- ◆ Adapté aux sirènes de 1,7 Amp. avec lecture à distance du courant de la sirène,
- ◆ Comprend deux relais de sorties programmables de 3A.



L'illustration ci-dessous (Figure 1) montre les divers éléments et cavaliers du module SMPS.

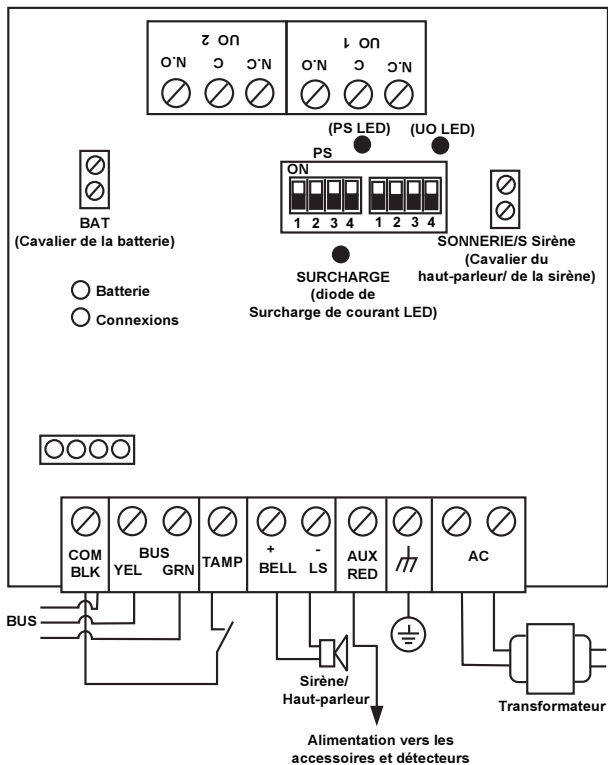

Figure 7 : SMPS – Vue générale

## Installation du module d'alimentation

Installez le SMPS et la batterie de réserve à l'intérieur d'un boîtier métallique :



### IMPORTANT !

La maintenance du module SMPS ne doit être effectuée que par un technicien qualifié !

Sauf en cas d'opérations de maintenance, le boîtier SMPS doit rester constamment fermé (couvercle vissé).

Les fils électriques utilisés doivent être conformes aux normes nationales. (Cf. Tableau 1: "Calibres des fils et câbles", page 70).

Le module SMPS est conçu pour usage en intérieur uniquement !

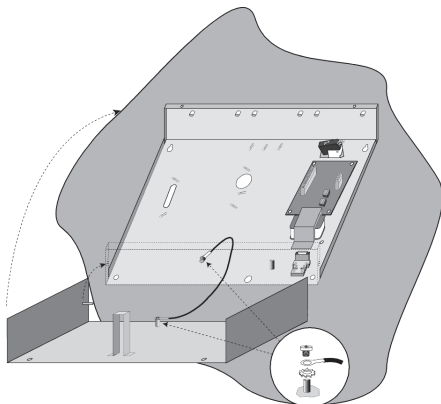

**Figure 8 : Module d'alimentation SMPS à l'intérieur d'un boîtier métallique**



### REMARQUE :

Avant d'installer le module, calculez la consommation électrique totale des appareils connectés afin de ne pas dépasser la consommation maximale du transformateur !



### IMPORTANT !

Afin de prévenir tout risque de choc électrique, débranchez toutes les sources électriques avant de réaliser une opération de maintenance ! En aucun cas, le secteur électrique ne doit être relié à la carte PCB si ce n'est à la borne de connexion principale !

1. Placez le boîtier métallique du module SMPS dans un endroit

propre et sec, près du réseau électrique.

2. Ouvrez le boîtier SMPS en desserrant les vis.
3. Pour fixer le boîtier au mur, il est recommandé d'utiliser des vis de diamètre  $\varnothing 4.2\text{mm}$  et de longueur 32mm (DIN 7981 4.2X32 ZP).
4. Reliez le câble d'arrivée du secteur à la borne de connexion du fusible principal comme l'indique la Figure 3 :
5. Connectez les terminaux du SMPS selon le schéma de "Power Supply Terminal Wiring", pages 8 à 9.

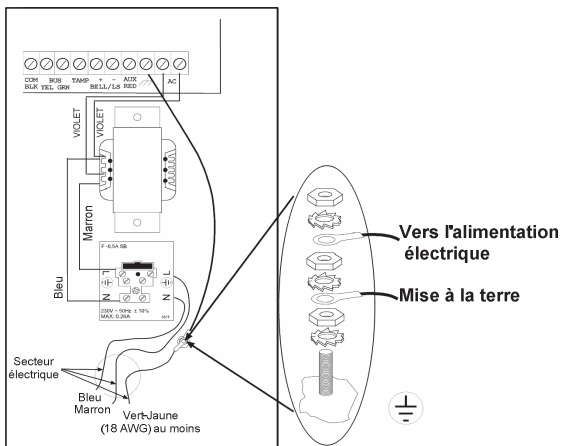

**Figure 9 : SMPS – Connexion au secteur AC et mise à la terre**

6. Placez les cavaliers SMPS et les micro-interrupteurs comme indiqué dans le chapitre "DIP Switches Settingsmicro-interrupteurs", page 64 et le paragraphe "Jumper Settings", page 65.
7. Installez la pile à l'emplacement prévu à cet effet, au bas du boîtier du SMPS.
8. Reliez les câbles libres (connecteurs de la batterie) de la carte

SMPS aux bornes de la batterie :  
(+) rouge, (-) noir).



**REMARQUE :**

N'utilisez que des batteries acide-plomb, 12V, 7-21AH (maximum), conformes aux normes nationales de sécurité !

- Effectuez la mise sous tension.
- Exécutez un test BUS en vous aidant du menu du ProSYS (veuillez consulter à cet effet le Guide d'installation et de programmation du ProSYS).
- A l'aide du logiciel ProSYS, exécutez un test diagnostic de la sortie SMPS et de la batterie, comme indiqué dans le chapitre du User Programming Menu, page 67.
- Fermez le boîtier métallique du SMPS.

**Câblage des Bornes de Connexion**

Terminal	Description / Action
<b>COM BLK</b> (COM Noir)	Les bornes du BUS: servent à relier le module SMPS et celui de sortie programmable au BUS de communication ProSYS. Branchez les fils électriques, point par point, en respectant les couleurs indiquées.
<b>BUS YEL</b> (BUS Jaune)	
<b>BUS GRN</b> (BUS Vert)	



**REMARQUE :**

La distance maximale autorisée pour le câblage BUS entre le SMPS et le ProSYS est de 300m (1000ft) !



**IMPORTANT !**

**NE BRANCHEZ PAS** le terminal AUX (Rouge) au BUS ProSYS. Assurez-vous que le fil d'arrivée AUX (habituellement rouge) en provenance du BUS ProSYS est bien déconnecté !

<b>TAMP</b> (SABOT.)	Sert à relier l'interrupteur d'autoprotection du boîtier entre les bornes <b>SABOT.</b> et <b>COM</b> (normalement fermés).
-------------------------	---

**REMARQUE :**

1. Il n'est pas nécessaire d'utiliser l'autoprotection du boîtier si un autre module relié au même boîtier en a déjà une.
2. Pour éviter toute panne d'autoprotection, si AUCUNE connexion n'est établie pour le terminal SABOT., branchez un fil électrique entre les terminaux **SABOT.** et **COM.**
3. N'utilisez pas de résistance de Fin de Ligne dans le circuit de l'interrupteur d'autoprotection !

**BELL/ LS  
SIRENE(S)**

Sert à relier une sirène externe gérée par le SMPS (sonnerie ou haut-parleur). Placez le cavalier de la ou des sonneries de l'appareil connecté en suivant en détail les instructions du chapitre Jumper Settings, page 11.

**REMARQUES :**

1. Pour éviter toute panne du circuit de la sirène, si AUCUNE connexion n'est réalisée pour les terminaux de SIRENE/S, reliez une résistance 2,2K $\Omega$  à l'endroit prévu à cet effet.
2. Utilisez une valeur supérieure si la distance entre la sirène et le SMPS est grande. Tenez compte de la consommation en courant de la ou des sirènes pour choisir le calibre des fils (page 72).

**AUX RED (+)  
AUX Rouge (+)**

Utilisé avec le terminal COM (-) pour alimenter les appareils Aux. (par ex. les détecteurs PIR, de fumée/ bris de glace et tout autre appareil nécessitant une alimentation 12VDC). La consommation totale en courant du SMPS (via les terminaux Aux./COM et SIRENE/S) est de 3A.

**REMARQUE:**

Si une ou plusieurs sortie(s) AUX/SIRENE/S est (sont) surchargée(s) et que le SMPS s'éteint, aidez-vous du logiciel ProSYS pour réinitialiser le SMPS, comme suit :

Du menu principal ProSYS de l'Utilisateur, appuyez sur  [2] [0] [2] (Option de Rétablissement de Surcharge), ou entrez et sortez du mode d'Installation-Programmation (veuillez consulter le Guide d'installation du ProSYS).

Si la surcharge persiste, réinitialisez manuellement en procédant comme suit :

Déconnectez toutes les charges des terminaux AUX/COM pendant au moins 10 secondes, puis reconnectez l'une des charges aux terminaux AUX/COM. Ensuite, réactivez l'option de Rétablissement de surcharge à partir du menu principal ProSYS de l'Utilisateur (cf. le chapitre "Installer Programming Menu" page 66).

<b>Ground TERRE</b> (Mise à la terre)	Sert à relier la borne de connexion TERRE à la broche principale de mise à la terre du boîtier (cf. illustration page 6). Utilisez 1,5mm <sup>2</sup> (16 AWG) (au minimum).
<b>AC</b>	Sert à relier les connexions du secteur AC (cf. illustration page 6) aux sorties du transfo (16.5VAC/50 VA).

**REMARQUE :**

Un disjoncteur facile d'accès doit être incorporé à l'installation électrique du bâtiment.

**Câblage de la sortie relais****REMARQUE :**

Si vous utilisez la sortie programmable SMPS, tenez compte du fait que dans ce cas, une des sorties d'extension du ProSYS est utilisée !

Le module de sortie programmable SMPS comprend deux relais (Contacts secs) de type "Roulement" (*fonctionnement à tour de rôle*).

Description de la borne de connexion (terminal) :

**NO** = Normalement ouvert

**NF** = Normalement fermé

**C** = Commun

Reliez chacune des sorties relais SMPS selon la configuration de votre choix.

**Éléments de l'alimentation électrique**

Les fonctions de la diode électroluminescente LED, micro-interrupteurs,

cavaliers et connexions sont décrites ci-dessous.

#### Indications de la diode électroluminescente LED

LED	Description
<b>ALIM (PS)</b> (Transmission de l'alimentation électrique)	Indique l'état de transmission entre l'alimentation électrique et la centrale.
	<b>Marche (ON)</b> : transmission normale avec la centrale.
	<b>Arrêt (OFF)</b> : absence d'arrivée de courant.
	<b>Clignotement</b> : panne de transmission du BUS, le système est en mode Installation ou l'interrupteur DIP 4 est éteint (OFF).
<b>SP</b> (Communication de la sortie programmable)	Indique l'état de communication entre le module SP (sortie programmable) SMPS et la centrale.
	<b>Marche (ON)</b> : communication normale avec la centrale.
	<b>Arrêt (OFF)</b> : absence d'arrivée de courant.
	<b>Clignotement</b> : panne de communication du BUS, le système est en mode Installation ou l'interrupteur DIP 4 est éteint (OFF).

LED	Description
OC (Surcharge)	Indique une surcharge (calculée).réelle ou potentielle
	<b>Marche (ON)</b> : la consommation électrique totale des sorties AUX et SIRENE/S dépasse 3A (coupure de courant aux deux sorties).
	<b>Arrêt (OFF)</b> : consommation électrique normale.
	<b>Clignotement</b> : Le module SMSP a détecté une consommation en courant excessive potentielle en calculant le total de la consommation en courant réelle de la sortie AUX et de celle demandée par la SIRENE/S.
 <b>REMARQUE :</b>	
	Pour calculer la consommation en courant de la sirène, celle-ci doit être activée au moins une fois (de préférence à la fin de l'installation).

### Réglages des micro-interrupteurs DIP

Module	Interrupteur DIP	Description
Alimentation	PS/SW1-SW3	Sert à définir un numéro ID unique attribué au module du BUS pour la communication.
	PS/SW4	Active/ désactive la communication entre l'Alimentation et le ProSYS. <b>Marche (ON)</b> (vers le haut) : communication activée. <b>Arrêt (OFF)</b> (vers le bas) : communication désactivée.
Sortie Programmable (SP)	UO/ SW1-SW3	Sert à définir un numéro ID unique au module SP qui se trouve sur la carte SMPS.
	UO/SW4	Active/ désactive la communication entre le module SP et le ProSYS. <b>Marche (ON)</b> (vers le haut) : communication activée. <b>Arrêt (OFF)</b> (vers le bas) : communication désactivée









#### REMARQUE :

Quand le PS/SW4 ou le UO/SW4 est éteint (OFF), le numéro ID défini par SW1-SW3 n'est pas identifié par le ProSYS et peut alors servir à la connexion d'un autre accessoire de même catégorie. La diode LED des SP/PS (ALIM) clignote pour indiquer l'absence de communication avec la centrale.



## Réglages des cavaliers

Cavalier	Description	
BAT	Protection anti-décharge de la batterie.	
	 <p>Protection active (ON)</p>	En cas de rupture de l'alimentation du secteur AC, le SMPS déconnecte automatiquement la batterie dès que la tension de la batterie de réserve tombe en dessous de 10,8 VDC, pour en empêcher un "déchargement excessif" qui pourrait la détériorer.
	 <p>Protection non active (OFF)</p>	La batterie est susceptible de se décharger complètement en cas de panne de secteur AC (puisque sans protection contre une décharge excessive).
	 <p><b>REMARQUE :</b></p> <p>La sélection de la configuration à 2 broches risque d'entraîner la détérioration de la batterie, et en conséquence, de nécessiter son remplacement.</p>	
SIRENE/S	Sert à déterminer le mode d'opération du SMPS selon la sirène reliée aux connexions de SIRENE/S.	
	 <p><b>REMARQUE :</b></p> <p>Le fonctionnement de la ou des sirène(s) reliée(s) au SMPS est identique à celui des sirènes de la centrale.</p>	
	<p>Sonnerie</p> 	Pour une sirène électronique/ sonnerie avec coupleur intégré, positionnez le cavalier sur une broche; un courant 12VDC est produit aux bornes de la sirène pendant les alarmes "Panique"/ "Effraction". Une tension à pulses lents est produite en cas d'alarme "Incendie".
<p>HP (LS) (Haut-parleur)</p> 	Pour un haut-parleur sans coupleur de sirène intégré, positionnez le cavalier sur les deux broches. Le SMPS produit alors une tension oscillante continue pour les alarmes "Panique"/ "Effraction" et une tension oscillante intermittente en cas d'alarme "Incendie".	

## Programmation du SMPS

Ce chapitre décrit les fonctions logicielles supplémentaires du ProSYS, destinées au SMPS.

Il est vivement recommandé de lire attentivement et de bien comprendre la procédure d'installation du ProSYS avant de commencer la programmation du SMPS !

8 modules d'alimentation maximum peuvent être connectés (Alimentation normale 1,5A ou SMPS 3A).

Le ProSYS peut recevoir jusqu'à 8 extensions de Sorties programmables suivant les indications du tableau suivant :

	ProSYS 16	ProSYS 40	ProSYS 128
Nombre maximum d'extensions SP	2	4	8

## Menu de Programmation Installateur

Fonction	Touche rapide	Description
<b>Ajouter/Supprimer un module d'Alimentation</b>	[7] [1] [4]	Sélection d'un nouveau type : <b>PS02</b> , suivi de la sélection d'un(e) Sirène/ Haut-parleur (s'il (elle) existe) et de l'affectation de la partition.
<b>Ajouter/Supprimer module de Sortie programmable</b>	[7] [1] [3]	Nouveau type : <b>UO02</b> Module relais à deux sorties.

## Menu de Programmation Utilisateur

Fonction	Touche rapide	Description
<b>Rétablir la Surcharge</b>	<p style="text-align: center;">*</p> <p>[2] [0] [2]</p>	<p><b>REMARQUE :</b> A accomplir uniquement que si la sortie Aux. est effectivement en surcharge, le code est requis et le SMPS concerné sélectionné.</p> <p>L'Administrateur / Installateur/ Sub-installateur/ manager peut utiliser cette option pour rétablir l'alimentation de la sortie Aux. (Si l'état de surcharge persiste, il est nécessaire de déconnecter toutes les charges de sorties AUX. !).</p>
<b>Afficher Panne</b>	<p style="text-align: center;">*</p> <p>[3] [1]</p>	<p>Messages de pannes destinés au SMPS :</p> <p><b>Surcharge potentielle</b> : le SMSP a détecté une surcharge potentielle de courant en calculant le total de consommation électrique prévu aux sorties Sirène et Aux.</p> <p><b>Surcharge</b> : la consommation en courant totale des sorties Sirène et Aux. dépasse 3A.</p>
<b>Test Batterie</b>	<p style="text-align: center;">*</p> <p>[4] [CODE] [2]</p>	<p>Teste la batterie de réserve du SMPS présélectionné. La tension de la batterie du module SMPS concerné s'affiche sur l'écran du clavier LCD.</p>

Fonction	Touche rapide	Description
<b>Diagnostic SMPS</b>	 [4] [Code Installateur] [#][9][2]	<p><b>Tension de la batterie</b> (du SMPS présélectionné); teste la tension électrique de la batterie.</p> <p><b>Charge Auxiliaire</b> (du SMPS concerné): tension de sortie Aux. et courant du SMPS en temps réel. Ces deux valeurs s'affichent sur l'écran du clavier LCD.</p> <p><b>Charge de la Sirène</b> (du SMPS concerné); affiche la consommation en courant de la sirène. Le SMPS vérifie la charge de la sirène à chaque fonctionnement de celle-ci. La dernière donnée mesurée s'affiche sur l'écran du clavier LCD.</p>

#### REMARQUE :



Les fonctions de diagnostic peuvent également s'appliquer sur place ou à distance, à partir du logiciel de Téléchargement/ Télétransmission fourni séparément.

## Messages du Journal

La liste qui suit présente les divers messages consacrés au journal ou historique des événements du SMPS, tels qu'ils s'affichent sur l'écran du clavier LCD :

Message d'évènement	Signification
S=X RENINIT. RC=YY	Surcharge dans le SMPS X. Réinitialisé par l'utilisateur YY.
SURCH. POT. PS=X	Surcharge potentielle du SMPS identifié par le numéro ID (1-8)=X
REINIT. SURCH. POT. PS=X	Rétablissement de la surcharge potentielle du SMPS, identifié par le numéro ID (1-8)=X
SURCH. PS=X	Surcharge du SMPS identifié par le numéro ID =X
REINIT. SURCH. PS=X	Rétablissement de la surcharge du SMPS, identifié par le numéro ID (1-8)=X
BATT. FAIBLE PS=X	Indication de Batterie faible, correspondant au numéro ID du SMPS (1-8)=X
REINIT. BATT. FAIBLE PS=X	Restauration de Batterie faible correspondant au numéro ID du SMPS (1-8)=X

## Localisation des pannes

Ce chapitre présente les problèmes susceptibles de survenir dans le système, et leurs solutions. Effectuez toujours les vérifications préliminaires suivantes avant de vous reporter au tableau de localisation des pannes. Effectuez un contrôle visuel complet du module SMPS, de sa batterie et du transformateur AC pour détecter tout signe éventuel de dommage mécanique, de connexions défectueuses ou de fils usés. Vérifiez les connexions de l'arrivée de l'alimentation AC, du transformateur AC et de la batterie.

Panne	Signification/ Cause probable	Solution
<b>Panne de secteur AC</b>	Indique un problème de secteur.	Vérifiez l'arrivée du secteur et le fusible de l'armoire électrique. Remplacez, si nécessaire, le fusible par un fusible du même ampérage.
<b>Panne de circuit de la sirène</b>	Indique que la sirène est défectueuse, ou qu'elle n'est pas connectée.	Vérifiez le câblage de la sonnerie/sirène. Si la sirène ne doit pas être utilisée, sélectionnez l'option "Pas de sirène/Haut-parleur" du menu du ProSYS (cf. Installer Programming Menu, page 62).
<b>Panne de Batterie faible</b>	Absence de batterie, batterie défectueuse, ou batterie à recharger	Vérifiez la tension de la batterie; si nécessaire, remplacez-la ou attendez qu'elle se recharge.
<b>Diode ALIM/SP clignotante</b>	Problème de communication	<ol style="list-style-type: none"> <li>1. Vérifiez le bon réglage ID du micro-interrupteur DIP concerné (ALIM ou SP) et sa configuration de communication.</li> <li>2. Contrôlez la bonne distance de câblage (cf. page 17).</li> <li>3. Effectuez un test de BUS à partir du menu ProSYS.</li> </ol>
<b>Diode SURGHAGE Clignotante</b>	Indique une surcharge potentielle	Déconnecte un ou plusieurs accessoires de la sortie AUX. ou SIRENE. Utilisez les diagnostics ProSYS pour contrôler les valeurs de charge du système (cf. User Programming Menu, page 67).

Panne	Signification/ Cause probable	Solution
<b>Pas d'alimentation de sortie du SMPS</b>	SMPS défectueux	Affiche les pannes d'alimentation à l'aide du clavier LCD du <b>ProSYS</b> . Vérifiez que le système ne présente pas de courts-circuits. Rétablissez le SMPS (cf. User Programming Menu, page 67).
<b>Le système ne fonctionne pas</b>	Le micro-interrupteur DIP de l'ALIM/SP doit être changé.	Réinitialisez le SMPS (cf. User Programming Menu, page 67), déconnectez la batterie et les fils de branchement au secteur, attendez quelques secondes et rebranchez le tout.
<b>Les relais SP ne fonctionnent pas correctement</b>	Programmation incorrecte de la SP	A l'aide du menu <b>ProSYS</b> , vérifiez que les fonctions SP sont correctement programmées.
<b>Test BUS inférieur à 98%</b>	Communication instable avec l'Alimentation ou la Sortie Programmable	La distance entre le ProSYS et le SMPS est trop grande; ajustez la distance et vérifiez le calibrage des fils (cf. tableau 1 : Calibre des fils et câbles).

## Tests à effectuer après l'installation

A la fin de l'installation et à l'aide du menu ProSYS, effectuez un test de bon fonctionnement du SMPS en lui appliquant les tests de Vérification des Modules et de Communication BUS.

## Spécifications techniques

### Généralités

- ◆ Efficacité : 93% @ 1A de charge, 85 % Min @ 3A de charge complète.
- ◆ Dimensions de la carte SMPS (HxLxP): 90mm x110mm
- ◆ Poids : 0,14Kg
- ◆ Connexion de la centrale : RS485, BUS à 3 fils, jusqu'à 300m de la centrale.

### Entrée

- ◆ Alimentation : 16.5VAC @ 50VA (avec transformateur 230VAC/16,5VAC/50Hz).
- ◆ Batterie de réserve rechargeable : 12V jusqu'à 21 Amp.-heures (AH)
- ◆ Seuil bas de la batterie: 11V

### Sortie

- ◆ Sortie Auxiliaire : 3A @13VDC
- ◆ Sortie Sonnerie/ Sirène : 1,7A @13VDC
- ◆ Protection anti-surcharge : Protection électronique automatique.

### Sortie Programmable

- ◆ 12VDC @ 3A max – Relais (Contact secs)

### Spécifications environnementales

- ◆ Température de fonctionnement : 0° à 55°C

## Fils électriques

L'utilisation de fils et câbles parfaitement appropriés est une condition nécessaire à la réussite de l'installation et au bon fonctionnement du module SMPS. Il est important de choisir les fils de la bonne taille pour réduire les pertes de puissance et assurer le fonctionnement fiable de l'appareil. Pour cela, tenez compte à la fois des exigences d'ordre électrique et des distances impliquant les câbles.

Tableau 2: Calibre des fils en mm<sup>2</sup> et câbles AWG

Amp	32 (0,031mm <sup>2</sup> )		30 (0,049mm <sup>2</sup> )		28 (0,08 mm <sup>2</sup> )		26 (0,13 mm <sup>2</sup> )		24 (0,2 mm <sup>2</sup> )	
	Dist. Max Run		Dist. Max Run		Dist. Max		Dist. Max		Dist. Max	
	m.	ft	m.	ft	m.	ft	m.	ft	m.	ft
0.2	8,2	27.	30	42.	19,4	63.	32,8	108	51,	16
04	4,1	13.	12	21.	9,7	31.	16,4	53.	25,	84
06	2,7	9.0	6,	14.	6,5	21.	10,9	35.	17,	56
08	2,1	6.7	4,	10.	4,8	15.	8,2	26.	12,	42
1	1,6	5.4	3,	8.4	3,9	12.	6,6	21.	10,	33
1.2	1,4	4.5	2,	7.0	3,2	10.	5,5	18.	8,6	28
1.4	1,2	3.9	2,	6.0	2,8	9.1	4,7	15.	7,3	24
1.6	1,0	3.4	1,	5.3	2,4	8.0	4,1	13.	6,4	21
1.8	0,9	3.0	1,	4.7	2,2	7.1	3,6	12.	5,7	18
2	0,8	2.7	1,	4.2	1,9	6.4	3,3	10.	5,1	16
2.2	0,7	2.5	1,	3.8	1,8	5.8	3,0	9.8	4,7	15
2.4	0,7	2.2	1,	3.5	1,6	5.3	2,7	9.0	4,3	14
2.6	0,6	2.1	1,	3.2	1,5	4.9	2,5	8.3	4,0	13
2.8	0,6	1.9	1,	3.0	1,4	4.5	2,3	7.7	3,7	12
3.0	0,5	1.8	0,	2.8	1,3	4.2	2,2	7.2	3,4	11

Amp	22 (0.33 mm <sup>2</sup> )		20 (0.5 mm <sup>2</sup> )		18 (0.82 mm <sup>2</sup> )		16 (1.3 mm <sup>2</sup> )		14 (2 mm <sup>2</sup> )	
	Dist. Max		Dist. Max		Dist. Max		Dist. Max		Dist. Max	
	m.	ft	m.	ft	m.	ft	m.	ft	m.	ft
0.2	87.0	285.6	132	433	206	674	346	1,136	527	1,729
04	43.5	142.8	66,0	217	103	337	173	568	264	864
06	29.0	95.2	44,0	144	68.5	225	115	379	176	576
08	21.8	71.4	33,0	108	51.4	169	87	284	132	432
1	17.4	57.1	26,4	86.6	41.1	135	69	227	105	346
1.2	14.5	47.6	22,0	72.2	34.2	112	58	189	88	288
1.4	12.4	40.8	18,9	61.9	29.4	96	50	162	75	247



	22 (0.33 mm <sup>2</sup> )		20 (0.5 mm <sup>2</sup> )		18 (0.82 mm <sup>2</sup> )		16 (1.3 mm <sup>2</sup> )		14 (2 mm <sup>2</sup> )	
1.6	10.9	35.7	16,5	54.1	25.7	84	43	142	66	216
1.8	9.7	31.7	14,7	48.1	22.8	75	39	126	59	192
2	8.7	28.6	13,2	43.3	20.5	67	35	114	53	173
2.2	7.9	26.0	12,0	39.4	18.7	61	32	103	48	157
2.4	7.3	23.8	11,0	36.1	17.1	56	29	95	44	144
2.6	6.7	22.0	10,2	33.3	15.8	52	27	87	41	133
2.8	6.2	20.4	9.4	30.9	14.7	48	25	81	38	123
3.0	5.8	19	8.8	28.9	13.7	45	23	76	35	115

	12 (3,3 mm <sup>2</sup> )		10 (5,26 mm <sup>2</sup> )		8 (8 mm <sup>2</sup> )		6 (13,6 mm <sup>2</sup> )		4 (21,73mm <sup>2</sup> )		2 (34,65 mm <sup>2</sup> )	
	Dist. Max		Dist. Max		Dist. Max		Dist. Max		Dist. Max		Dist. Max	
Amp	m.	ft	m.	ft	m.	ft	m.	ft	m.	ft	m.	ft
0.2	83	2,73										
04	41	1,36	662	2,17	1,02	3,35						
06	27	911	441	1,44	682	2,23	1,00	3,28				
08	20	684	331	1,08	511	1,67	750	2,46				
1	16	547	265	868	409	1,34	600	1,96	1,12	369		
1.2	13	456	221	724	341	1,11	500	1,64	938	307		
1.4	11	391	189	620	292	959	429	1,40	804	263		
1.6	10	342	165	543	256	839	375	1,23	703	230	1,12	3,69
1.8	93	304	147	482	227	746	333	1,09	625	205	1,00	3,28
2	83	273		434	205	671	300	984	563	184	900	2,95
2.2	76	249	120	395	186	610	273	895	511	167	818	2,68
2.4	69	228	110	362	171	559	250	820	469	153	750	2,46
2.6	64	210	102	334	157	516	231	757	433	142	692	2,27
2.8	60	195	95	310	146	479	214	703	402	131	643	2,10
3.0	56	182	88	289	136	447	200	656	375	123	600	1,96

## Codes catalogue

Référence	Description
RP128EPS000A	Carte SMPS
RP128PSPSEUA	SMPS + transformateur dans un boîtier métallique

## RTTE Compliance Statement:

Hereby, RISCO Group declares that this equipment is in compliance with the essential requirements and other relevant provisions of Directive 1999/5/EC. For the CE Declaration of Conformity please refer to our website: [www.riscogroup.com](http://www.riscogroup.com).

## Standard Limited Product Warranty

RISCO Ltd., its subsidiaries and affiliates ("**Risco**") guarantee Risco's hardware products to be free from defects in materials and workmanship when used and stored under normal conditions and in accordance with the instructions for use supplied by Risco, for a period of (i) 24 months from the date of connection to the Risco Cloud (for cloud connected products) or (ii) 24 months from production (for other products which are non-cloud connected), as the case may be (each, the "**Product Warranty Period**" respectively).

**Contact with customers only.** This Product Warranty is solely for the benefit of the customer who purchased the product directly from Risco, or from any authorized distributor of Risco. Nothing in this Warranty obligates Risco to accept product returns directly from end users that purchased the products for their own use from Risco's customer or from any installer of Risco, or otherwise provide warranty or other services to any such end user. Risco customer shall handle all interactions with its end users in connection with the Warranty, inter alia regarding the Warranty. Risco's customer shall make no warranties, representations, guarantees or statements to its customers or other third parties that suggest that Risco has any warranty or service obligation to, or any contractual privity with, any recipient of a product.

**Return Material Authorization.** In the event that a material defect in a product shall be discovered and reported during the Product Warranty Period, Risco shall, at its option, and at customer's expense, either: (i) accept return of the defective Product and repair or have repaired the defective Product, or (ii) accept return of the defective Product and provide a replacement product to the customer. The customer must obtain a Return Material Authorization ("**RMA**") number from Risco prior to returning any Product to Risco. The returned product must be accompanied with a detailed description of the defect discovered ("**Defect Description**") and must otherwise follow Risco's then-current RMA procedure in connection with any such return. If Risco determines in its reasonable discretion that any Product returned by customer conforms to the applicable warranty ("**Non-Defective Products**"), Risco will notify the customer of such determination and will return the applicable Product to customer at customer's expense. In addition, Risco may propose and assess customer a charge for testing and examination of Non-Defective Products.

**Entire Liability.** The repair or replacement of products in accordance with this warranty shall be Risco's entire liability and customer's sole and exclusive remedy in case a material defect in a product shall be discovered and reported as required herein. Risco's obligation and the Warranty are contingent upon the full payment by customer for such Product and upon a proven weekly testing and examination of the product functionality.

**Limitations.** The Product Warranty is the only warranty made by Risco with respect to the Products. The warranty is not transferable to any third party. To the maximum extent permitted by applicable law, the Product Warranty does not apply and will be void if: (i) the conditions set forth above are not met (including, but not limited to, full payment by customer for the product and a proven weekly testing and examination of the product functionality); (ii) if the Products or any part or component thereof: (a) have been subjected to improper operation or installation; (b) have been subject to neglect, abuse, willful damage, abnormal working conditions, failure to follow Risco's instructions (whether oral or in writing); (c) have been misused, altered, modified or repaired without Risco's written approval or combined with, or installed on products, or equipment of the customer or of any third party; (d) have been damaged by any factor beyond Risco's reasonable control such as, but not limited to, power failure, electric power surges, or unsuitable third party components and the interaction of software therewith or (e) any delay or other failure in performance of the product attributable to any means of communications, provided by any third party service provider (including, but not limited to) GSM interruptions, lack of or internet outage and/or telephony failure.

**BATTERIES ARE EXPLICITLY EXCLUDED FROM THE WARRANTY AND RISCO SHALL NOT BE HELD RESPONSIBLE OR LIABLE IN RELATION THERETO, AND THE ONLY WARRANTY APPLICABLE THERETO, IF ANY, IS THE BATTERY MANUFACTURER'S WARRANTY.**

Risco makes no other warranty, expressed or implied, and makes no warranty of merchantability or of fitness for any particular purpose. For the sake of good order and avoidance of any doubt:

**DISCLAIMER** EXCEPT FOR THE WARRANTIES SET FORTH HEREIN, RISCO AND ITS LICENSORS HEREBY DISCLAIM ALL EXPRESS, IMPLIED OR STATUTORY, REPRESENTATIONS, WARRANTIES, GUARANTEES, AND CONDITIONS WITH REGARD TO THE PRODUCTS, INCLUDING BUT NOT LIMITED TO ANY REPRESENTATIONS, WARRANTIES, GUARANTEES, AND CONDITIONS OF MERCHANTABILITY, FITNESS FOR A PARTICULAR PURPOSE, TITLE AND LOSS OF DATA. WITHOUT

LIMITING THE GENERALITY OF THE FOREGOING, RISCO AND ITS LICENSORS DO NOT REPRESENT OR WARRANT THAT: (i) THE OPERATION OR USE OF THE PRODUCT WILL BE TIMELY, SECURE, UNINTERRUPTED OR ERROR-FREE; (ii) THAT ANY FILES, CONTENT OR INFORMATION OF ANY KIND THAT MAY BE ACCESSED THROUGH THE PRODUCT BY CUSTOMER OR END USER SHALL REMAIN SECURED OR NON DAMAGED. CUSTOMER ACKNOWLEDGES THAT NEITHER RISCO NOR ITS LICENSORS CONTROL THE TRANSFER OF DATA OVER COMMUNICATIONS FACILITIES, INCLUDING THE INTERNET, GSM OR OTHER MEANS OF COMMUNICATIONS AND THAT RISCO'S PRODUCTS, MAY BE SUBJECT TO LIMITATIONS, DELAYS, AND OTHER PROBLEMS INHERENT IN THE USE OF SUCH MEANS OF COMMUNICATIONS. RISCO IS NOT RESPONSIBLE FOR ANY DELAYS, DELIVERY FAILURES, OR OTHER DAMAGE RESULTING FROM SUCH PROBLEMS.

RISCO WARRANTS THAT ITS PRODUCTS DO NOT, TO THE BEST OF ITS KNOWLEDGE, INFRINGE UPON ANY PATENT, COPYRIGHT, TRADEMARK, TRADE SECRET OR OTHER INTELLECTUAL PROPERTY RIGHT IN ANY EVENT RISCO SHALL NOT BE LIABLE FOR ANY AMOUNTS REPRESENTING LOST REVENUES OR PROFITS, PUNITIVE DAMAGES, OR FOR ANY OTHER INDIRECT, SPECIAL, INCIDENTAL, OR CONSEQUENTIAL DAMAGES, EVEN IF THEY WERE FORESEEABLE OR RISCO HAS BEEN INFORMED OF THEIR POTENTIAL.

Risco does not install or integrate the product in the end user security system and is therefore not responsible for and cannot guarantee the performance of the end user security system which uses the product.

Risco does not guarantee that the product will prevent any personal injury or property loss by burglary, robbery, fire or otherwise; or that the product will in all cases provide adequate warning or protection. Customer understands that a correctly installed and maintained alarm may only reduce the risk of burglary, robbery or fire without warning, but is not an assurance or a guarantee that such an event will not occur or that there will be no personal injury or property loss as a result thereof. Consequently Risco shall have no liability for any personal injury, property damage or loss based on a claim that the product fails to give warning.

No employee or representative of Risco is authorized to change this warranty in any way or grant any other warranty.

## Contacting RISCO Group

RISCO Group is committed to customer service and product support. You can contact us through our website ([www.riscogroup.com](http://www.riscogroup.com)) or at the following addresses:

### United Kingdom

Tel: +44-161-655-5500  
[technical@riscogroup.co.uk](mailto:technical@riscogroup.co.uk)

### Italy

Tel: +39-02-66590054  
[support@riscogroup.it](mailto:support@riscogroup.it)

### Spain

Tel: +34-91-490-2133  
[support-es@riscogroup.com](mailto:support-es@riscogroup.com)

### France

Tel: +33-164-73-28-50  
[support-fr@riscogroup.com](mailto:support-fr@riscogroup.com)

### Belgium

Tel: +32-2522-7622  
[support-be@riscogroup.com](mailto:support-be@riscogroup.com)

### USA

Tel: +1-631-719-4400  
[support-usa@riscogroup.com](mailto:support-usa@riscogroup.com)

### China

Tel: +86-21-52-39-0066  
[support-cn@riscogroup.com](mailto:support-cn@riscogroup.com)

### Israel

Tel: +972-3-963-7777  
[support@riscogroup.com](mailto:support@riscogroup.com)

EN50131-3 Grade 3 Environmental class II  
EN50131-6, Type A



All rights reserved.

No part of this document may be reproduced in any form without prior written permission from the publisher.