

SP5500+ /SP6000+ / SP7000+ Programming Guide

4 to 32-Zone Expandable Security Systems



P ▲ R ▲ D O X™

Warranty

For complete warranty information on this product please refer to the Limited Warranty Statement found on our Web site: www.paradox.com. Your use of this Paradox product signifies your acceptance of all warranty terms and conditions.

Limitations of Alarm Systems

It must be understood that while your Paradox alarm system is highly advanced and secure, it does not offer any guaranteed protection against burglary, fire or other emergency (fire and emergency options are only available on certain Paradox models). This is due to a number of reasons, including but not limited to inadequate or improper installation/positioning, sensor limitations, battery performance, wireless signal interruption, inadequate maintenance or the potential for the system or telephone lines to be compromised or circumvented. As a result, Paradox does not represent that the alarm system will prevent personal injury or property damage, or in all cases provide adequate warning or protection.

Your security system should therefore be considered as one of many tools available to reduce risk and/or damage of burglary, fire or other emergencies, such other tools include but are not limited to insurance coverage, fire prevention and extinguish devices, and sprinkler systems.

We also strongly recommend that you regularly maintain your security systems and stay aware of new and improved Paradox products and developments.

TBR-21: In order to comply with TBR-21, standard force dialing must be enabled.

© 2022 Paradox Security Systems (Bahamas) Ltd. All rights reserved. Specifications may change without prior notice. One or more of the following US patents may apply: 7046142, 6215399, 6111256, 6104319, 5920259, 5886632, 5721542, 5287111, 5119069, 5077549 and RE39406. Canadian and international patents may also apply. Magellan, Spectra SP and BabyWare are trademarks or registered trademarks of Paradox Ltd. or its affiliates in Canada, the United States and/or other countries.

Things You Need to Know

About this Programming Guide

Use this programming guide to record programmed settings for your SP+ Series control panel. This guide should be used along with the SP+ Series Reference & Installation Manual (available online), whenever installing or programming your SP+ system.

Conventions

The following typographical conventions are used throughout this guide:

Default Settings: Values which appear in bold typeface signify the default value: e.g., Access code length: <input type="checkbox"/> 6 digits <input checked="" type="checkbox"/> 4 digits (4 digits is the default value)	 : Installer Quick Menu (indicates that information on the topic can also be found in the Installer Quick Menu on page 7)
Section numbers and keypad keys also appear in bold typeface, enclosed by brackets: e.g., Section [706] must be enabled...	NOTE: Suggestion, important information, or reminder

Installer Code

The default installer code is **0000**. This code allows you to enter programming mode, where you can program all features, options, and commands of the control panel, except for user codes. To change this code, see *System Codes* on page 27.

Maintenance Code

Similar to the installer code, the maintenance code allows you to enter programming mode and program all sections, except for user codes and communication settings (sections **[395]**, **[397]**, **[398]**, **[815]**, **[816]**, **[817]**, **[910]**, **[911]**, **[918]**, **[919]**, **[920]** to **[927]**, **[929]** to **[935]**, **[936]** to **[942]**, **[943]** to **[949]**) – these sections can only be accessed using the installer code. Since there is no default code, see *System Codes* on page 27 to set a default.

System Master Code

The default system master code is **1234**. The system master code allows you to utilize any arming method, as well as program user codes. To change the default code, see *System Codes* on page 27.

Panel Reset

Performing a panel reset will reset all panel settings to their preset, default values.

1. Press and hold the panel's **RESET** button until the **STATUS** LED flashes (5 seconds).
2. Release the **RESET** button, and then push it once more, within two seconds.

To reset the panel to its default settings using section programming, see section **[950]** in *Usability Sections*, on page 52.

Entering Programming Mode

To enter programming mode, proceed as follows:

1. Press **ENTER**.
2. Enter your installer or maintenance code. Upon entering your code, the **ARM** and **STAY** LEDs will flash. To modify codes, see *System Codes* on page 27.
3. Enter the three-digit section you wish to program. The **ARM** and **STAY** LEDs remain illuminated.
4. Enter required data.

NOTE: To enter programming mode, all zones must be disarmed and StayD mode deactivated. To deactivate StayD, press **OFF**, enter your master or user code, and then press **OFF**.

Data Entry and Display

To access the data display mode, access the desired section and press **ENTER** before entering any data. Depending on the keypad(s) configured to your system, specific LEDs or icons will flash, thus indicating that you are in data display mode. Each time **ENTER** is pressed, the keypad will display the next digit in the current section, and will continue to do so through all the remaining sections, one digit at a time, without changing the programmed values; this is not available for sections using the *multiple feature select method*. Press **CLEAR** at any time, to exit data display mode.

There are two methods that can be used to enter data when in programming mode: *single digit data entry* and *feature select programming*.

Single Digit Data Entry Method

After entering programming mode, some sections will require you to enter decimal values from 000 to 255. Other sections will require that you enter hexadecimal values from 0 to F. The required data will be clearly indicated in this guide. When entering the final digit in a section, the panel will automatically save and advance to the next section. See *Decimal and Hexadecimal Programming* for details on the various keys, and their equivalent decimal and hexadecimal values.

Feature Select Programming Method

After entering certain sections, eight options will be displayed. In these instances, each option (from 1 to 8) represent a specific feature. To turn enable the option, press the key corresponding to the desired option. Press the key again to remove the digit, thereby, disabling the option. Press **SLEEP** to disable all eight options. When the options are set, press **ENTER** to save your settings and advance to the next section.

Viewing Version Numbers

Table 1: Viewing panel and keypad version numbers

Step	Action	Details	When Viewing Keypad Version
1	Enter viewing mode: • For panel version, enter section [980] • For keypad version, enter installer programming, then press and hold ARM	The first digit is displayed (usually 0)	Digit 1: ARM is illuminated
2	Press ENTER	The second digit is displayed	Digit 2: SLEEP is illuminated
3	Press ENTER	The third digit is displayed	Digit 3: STAY is illuminated
4	Press ENTER	The fourth digit is displayed	Digit 4: OFF is illuminated

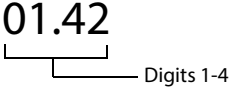
Example: Version **01.42**

 Digits 1-4

NOTE: For keypads K10V/H and K636, the keypad version numbers cannot be viewed.

Decimal and Hexadecimal Programming

Table 2: Decimal and hexadecimal values for 10 and 32-Zone LED keypads

Value or Action	Key	Result	
		32-Zone LED	10-Zone LED
Value 0/replace current digit with 0	SLEEP	Erase digit and remain in section	Erase digit and remain in section
Values 1 to 9	1 to 9	Zone 1 to 9	Keys 1 to 9
A (hex only)	0	Zone 10	Key 0 (10)
B (hex only)	OFF	Zone 11	OFF
C (hex only)	BYP	Zone 12	BYP
D (hex only)	MEM	Zone 13	MEM
E (hex only)	TBL	Zone 14	TBL
F (hex only)	⏻	Zone 15	⏻
Exit without saving	CLEAR	Arm and Stay LEDs flash	Arm and Stay LEDs flash
Save data (hex only)	ENTER	Advances to next section	Advances to next section

Contents

Worksheet 1: Planning Bus Modules	8
Worksheet 2: Planning Wireless Keypads	9
Worksheet 3: Planning Wireless Sirens	9
Worksheet 4: Planning Programmable Outputs	10
Worksheet 5: Planning Wireless Repeaters	10
Worksheet 6: Planning Zones	10
Worksheet 7: Zone Definitions	14
Worksheet 8: Custom Zone Definitions	14
Worksheet 9: Timers	15
Worksheet 10: Wireless Zones	16
Worksheet 11: Zone Report Codes	16
Worksheet 12: Zone Labels	17
Worksheet 13: Programmable outputs for SP+ Series control panels	17
Worksheet 14: PGM Activation/Deactivation Events	24
Worksheet 15: PGM Delays	26
Worksheet 16: PGM Serial Numbers	26
Worksheet 17: PGM Labels	26
Worksheet 18: User System Codes	27
Worksheet 19: User Code Options	27
Worksheet 20: User Report Codes	28
Worksheet 21: User Labels	28
Worksheet 22: Wireless Repeater Assignment	29
Worksheet 23: Wireless Repeater Labels	31
Worksheet 24: Wireless Keypad Assignment	31
Worksheet 25: Wireless Keypad Labels	33
Worksheet 26: Programming Remote Controls	34
Worksheet 27: Wireless Siren Assignment	35
Worksheet 28: Wireless Siren Labels	35
Worksheet 29: System Timers	38
Worksheet 30: Keypad Lockout	38
Worksheet 31: Daylight Savings Time	39
Worksheet 32: Partition Timers	40
Worksheet 33: Partition Labels	40
Worksheet 34: SMS Site Name	40
Worksheet 35: Bus Module Labels	40
Worksheet 36: Report Codes and Partition Accounts	43
Worksheet 37: Landline Communication Settings	43
Worksheet 38: Communication Timers	43
Worksheet 39: Test Report and Report Delays	44
Worksheet 40: Special Arming and Disarming Report Codes	44
Worksheet 41: Special Alarm Report Codes	44
Worksheet 42: Special Trouble Report Codes	45
Worksheet 43: System Trouble Restore Codes	45
Worksheet 44: System Special Report Codes	45
Worksheet 45: Communication Report Codes	50
Worksheet 46: Communication Restore Report Codes	50
Worksheet 47: Additional Communication Timers	50
Worksheet 48: BabyWare Options	51
Worksheet 49: IP Account Numbers	51
Worksheet 50: Software and PCS Connection Settings	51
Worksheet 51: IP Receiver 1 Configuration	52
Worksheet 52: IP Receiver 2 Configuration	52
Worksheet 53: IP Receiver Backup Configuration	52
Worksheet 54: System Timers	63
Worksheet 55: Keypad Lockout	64
Worksheet 56: Communication Timers	64

List of Worksheets

Worksheet 57: Planning Bus Modules	8
Worksheet 58: Planning Wireless Keypads	9
Worksheet 59: Planning Wireless Sirens	9
Worksheet 60: Planning Programmable Outputs	10
Worksheet 61: Planning Wireless Repeaters	10
Worksheet 62: Planning Zones	10
Worksheet 63: Zone Definitions	14
Worksheet 64: Custom Zone Definitions	14
Worksheet 65: Timers	15
Worksheet 66: Wireless Zones	16
Worksheet 67: Zone Report Codes	16
Worksheet 68: Zone Labels	17
Worksheet 69: Programmable outputs for SP+ Series control panels	17
Worksheet 70: PGM Activation/Deactivation Events	24
Worksheet 71: PGM Delays	26
Worksheet 72: PGM Serial Numbers	26
Worksheet 73: PGM Labels	26
Worksheet 74: User System Codes	27
Worksheet 75: User Code Options	27
Worksheet 76: User Report Codes	28
Worksheet 77: User Labels	28
Worksheet 78: Wireless Repeater Assignment	29
Worksheet 79: Wireless Repeater Labels	31
Worksheet 80: Wireless Keypad Assignment	31
Worksheet 81: Wireless Keypad Labels	33
Worksheet 82: Programming Remote Controls	34
Worksheet 83: Wireless Siren Assignment	35
Worksheet 84: Wireless Siren Labels	35
Worksheet 85: System Timers	38
Worksheet 86: Keypad Lockout	38
Worksheet 87: Daylight Savings Time	39
Worksheet 88: Partition Timers	40
Worksheet 89: Partition Labels	40
Worksheet 90: SMS Site Name	40
Worksheet 91: Bus Module Labels	40
Worksheet 92: Report Codes and Partition Accounts	43
Worksheet 93: Landline Communication Settings	43
Worksheet 94: Communication Timers	43
Worksheet 95: Test Report and Report Delays	44
Worksheet 96: Special Arming and Disarming Report Codes	44
Worksheet 97: Special Alarm Report Codes	44
Worksheet 98: Special Trouble Report Codes	45
Worksheet 99: System Trouble Restore Codes	45
Worksheet 100: System Special Report Codes	45
Worksheet 101: Communication Report Codes	50
Worksheet 102: Communication Restore Report Codes	50
Worksheet 103: Additional Communication Timers	50
Worksheet 104: BabyWare Options	51
Worksheet 105: IP Account Numbers	51
Worksheet 106: Software and PCS Connection Settings	51
Worksheet 107: IP Receiver 1 Configuration	52
Worksheet 108: IP Receiver 2 Configuration	52
Worksheet 109: IP Receiver Backup Configuration	52
Worksheet 110: System Timers	63
Worksheet 111: Keypad Lockout	64
Worksheet 112: Communication Timers	64



Installer Quick Menu

Zones

Step	Action	Details
1	+ installer code	= flash; programmed zones are lit (buttons or LED, depending on keypad); maintenance code may also be used
2	Zone number	Two digits: 01 to 32
3	Enroll or erase zone	Wireless zone: open/close cover or press LEARN/TAMPER switch; for 2WPGM remove and re-install Jumper 2 (JP2) hardwired zone: press ENTER ; to erase a programmed zone, press and hold SLEEP for three seconds
4	Zone type	See <i>Zone Definitions</i> on page 13, for the zone type
5	Assign partition (1 and/or 2 + ENTER)	If applicable, assign the zone to one or both partitions, and then press ENTER ; by default, all zones are assigned to partition 1

NOTE: If applicable, partition 2 status LEDs display signal strength of selected wireless zone (4 LEDs = best signal; 1 LED = weak signal; no LEDs = hardwired panel/keypad zone).

Delays

Step	Action	Details
1	+ installer code	= flash; maintenance code may also be used
2		-
3	1 = entry delay 1	Default: 045 sec.
	2 = entry delay 2	Default: 045 sec.
	3 = exit delay	Default: 060 sec.
	4 = bell cut-off	Default: 004 min.
4	000 to 255	Entry/exit delay = seconds; bell cut-off = minutes

Time and Date

Step	Action	Details
1	+ installer code	= flash; maintenance code may also be used
2	+ 5	-
3	Time (HH:MM)	If HH = 13 or more, go to step 5
4	Time format	1 = 24 hr. format, 2 = AM, 3 = PM
5	Date (YYYY/MM/DD)	Enter the year/month/day

Walk Test Mode

Step	Action	Details
1	+ installer code	= flash; maintenance code may also be used
2		-
3	6	Activates or deactivates walk test mode

Installer and Maintenance Codes

Step	Action	Details
1	+ installer code	= flash
2		-
3	• 7 for installer code	-
	• 8 for maintenance code	
4	Code	Enter a four or six-digit code
5	Confirm code	Re-enter the four or six-digit code, to confirm

NOTE: To erase a code, press and hold **SLEEP** for three seconds.

BabyWare

Step	Action	Details
1	+ installer code	= flash
2		-
3	9	-
4	Phone # + ENTER	Enter PC phone number (up to 32 digits), and then press ENTER
5	Panel ID	Enter four-digit panel ID
6	PC password	Enter four-digit PC password

NOTE: To erase the BabyWare phone number, panel ID, and PC password, press and hold **SLEEP** for three seconds.

Monitoring Phone Number

Step	Action	Details
1	+ installer code	= flash
2		-
3	1	-
4	Phone # + ENTER	Enter monitoring station phone number (up to 32 digits), and then press ENTER
5	Partition 1 account #	-
6	• 1 for CID	SIA is not supported with GPRS/IP reporting
	• 2 for SIA	
7	Partition 2 account #	-

NOTE: To erase monitoring phone number, reporting format, and account numbers, press and hold **SLEEP** for three seconds.

Communicator

Step	Action	Details
1	+ installer code	= flash; maintenance code may also be used
2		-
3	2 = backup phone #	
	3 = personal phone #1	
	4 = personal phone #2	
	5 = personal phone #3	
	6 = personal phone #4	
7 = personal phone #5		
4	Phone # + ENTER	Enter phone number (up to 32 digits), and then press ENTER to proceed to the next phone number, or go to step 5 if option 8 was selected

Cancel Communication

Step	Action	Details
1	+ installer code	= flash; maintenance code may also be used
2		-
3	9	Cancels all communication with BabyWare and PCS module

Keypad Programming

Assigning Keypad Zone Numbers

Step	Action	Details
1	ENTER + installer code	ARM + STAY = flash; maintenance code may also be used
2	Press and hold for three seconds	ARM + STAY = ON
3	Zone number + ENTER	K35, K32, K32LCD, K32LX = two digits: 01 to 32 ; K636, K10V/H = one digit: 1 to 0 (10)

NOTE: To erase a keypad zone number, press **CLEAR**, and then **ENTER**.

Assigning Keypad Zone Numbers TM50/TM70

Step	Action	Details
1	Press and hold MENU + installer code	Enters into advanced programming
2	Program this unit	Ensure that zone temperature input is enabled
3	Press keypad zone number	Select your zone

Entry Point Zone Assignment (StayD)

Step	Action	Details
1	ENTER + installer code	ARM + STAY = flash
2	Press and hold OFF for three seconds	ARM + STAY = ON
3	Zone number	K35, K32RF, K37, K32LCD, K32LX = two digits: 01 to 32 ; K636, K10V/H = one digit: 1 to 0 (10; maximum ten zones); the first zone programmed will be the designated entry point and will flash; up to three more path zones can be added – these zones will light up and remain lit
4	ENTER	Press ENTER to save and exit

Keypad Input/Output Configuration (K636 V2.0 and higher)

Step	Action	Details
1	ENTER + installer code	ARM + STAY = flash
2	Press and hold ENTER for three seconds	ARM + STAY = ON
3	Option 1	ON = output switches to ground following system arming (blue wire, maximum 150 mA) OFF = input (keypad zone input)
4	Option 2	ON = output N.C. OFF = output N.O.

NOTE: When configuring as an output, clear the assigned keypad zone first.

PGMs

Step	Action	Details
1	+ installer code	= flash; maintenance code may also be used
2		-
3	PGM number	Two digits: 01 to 16
4	Enroll or erase PGM	Wireless PGM = press the LEARN/TAMPER switch or remove and re-install Jumper 2 (JP2) on module; hardwired PGM = press ENTER
5	PGM type	1 = Follow button or
		2 = Follow button or
		3 = Follow zone
		4 = Follow alarm
		5 = Follow bell
		6 = Follow arm
		7 = Follow Stay arm
		8 = Follow Sleep arm
6	If PGM type is 1, 2, 3, or 4 , enter activation delay	1 = Follow
		2 = 1 sec.
		3 = 5 sec.
		4 = 15 sec.
		5 = 30 sec.
		6 = 1 min.
		7 = 5 min.
		8 = 15 min.
		9 = 30 min.
		If PGM type is 5 , proceed to the next available PGM
If PGM type is 6, 7, or 8 , enter 1 and/or 2 + ENTER	If system is partitioned, select partition(s), and then press ENTER to proceed to the next available PGM	
7	If PGM type is 1 or 2 , enter two-digit remote control #	01 to 32 (00 = all remote controls); the control panel proceeds to the next available PGM
	If PGM type is 3 , enter two-digit zone #	01 to 32 (00 = all zones); the control panel proceeds to the next available PGM
	If PGM type is 4 , enter 1 and/or 2 + ENTER	If system is partitioned, select partition(s), and then press ENTER to proceed to the next available PGM

NOTE: To erase a PGM, press and hold **SLEEP** for three seconds.

System Planning

Bus Module Planning

Worksheet 1: Planning Bus Modules

<i>Serial # Sticker</i>	<i>Description</i>	<i>Path Zone (Entry Point)</i>	<i>Path Zone</i>	<i>Path Zone</i>	<i>Path Zone</i>
Bus Module 1					
Bus Module 2					
Bus Module 3					
Bus Module 4					
Bus Module 5					
Bus Module 6					
Bus Module 7					
Bus Module 8					
Bus Module 9					
Bus Module 10					
Bus Module 11					
Bus Module 12					
Bus Module 13					
Bus Module 14					
Bus Module 15					

NOTE: Paths are only applicable when StayD is enabled.

Wireless Keypad Planning

Worksheet 2: Planning Wireless Keypads

Serial # Sticker	Description	Path Zone (Entry Point)	Path Zone	Path Zone	Path Zone
Wireless Keypad 1					
Wireless Keypad 2					
Wireless Keypad 3					
Wireless Keypad 4					
Wireless Keypad 5					
Wireless Keypad 6					
Wireless Keypad 7					
Wireless Keypad 8					

NOTE: When deleting a wireless keypad (K32RF/K37) from the system, the corresponding StayD path zones will also be deleted.

Wireless Siren Planning

Worksheet 3: Planning Wireless Sirens

Serial # Sticker	Description
Siren 1	
Siren 2	

Serial # Sticker	Description
Siren 3	
Siren 4	

Programmable Output (PGM) Planning

Worksheet 4: Planning Programmable Outputs

Serial # Sticker	Description
PGM 1	
PGM 2	
PGM 3	
PGM 4	
PGM 5	
PGM 6	
PGM 7	
PGM 8	

Serial # Sticker	Description
PGM 9	
PGM 10	
PGM 11	
PGM 12	
PGM 13	
PGM 14	
PGM 15	
PGM 16	

Wireless Repeater Planning

Worksheet 5: Planning Wireless Repeaters

Serial # Sticker	Description
Repeater 1	

Serial # Sticker	Description
Repeater 2	

Zone Planning

Worksheet 6: Planning Zones

Serial # Sticker	Zone #	Zone Description	Arming Method		
			Stay	Sleep	Full
Zone			<input type="checkbox"/>	<input type="checkbox"/>	<input type="checkbox"/>
Zone			<input type="checkbox"/>	<input type="checkbox"/>	<input type="checkbox"/>
Zone			<input type="checkbox"/>	<input type="checkbox"/>	<input type="checkbox"/>

Serial # Sticker	Zone #	Zone Description	Arming Method		
			Stay	Sleep	Full
Zone			<input type="checkbox"/>	<input type="checkbox"/>	<input type="checkbox"/>
Zone			<input type="checkbox"/>	<input type="checkbox"/>	<input type="checkbox"/>
Zone			<input type="checkbox"/>	<input type="checkbox"/>	<input type="checkbox"/>

Worksheet 6: Planning Zones (Continued)

Serial # Sticker	Zone #	Zone Description	Arming Method			Serial # Sticker	Zone #	Zone Description	Arming Method		
			Stay	Sleep	Full				Stay	Sleep	Full
Zone			<input type="checkbox"/>	<input type="checkbox"/>	<input type="checkbox"/>	Zone			<input type="checkbox"/>	<input type="checkbox"/>	<input type="checkbox"/>
Zone			<input type="checkbox"/>	<input type="checkbox"/>	<input type="checkbox"/>	Zone			<input type="checkbox"/>	<input type="checkbox"/>	<input type="checkbox"/>
Zone			<input type="checkbox"/>	<input type="checkbox"/>	<input type="checkbox"/>	Zone			<input type="checkbox"/>	<input type="checkbox"/>	<input type="checkbox"/>
Zone			<input type="checkbox"/>	<input type="checkbox"/>	<input type="checkbox"/>	Zone			<input type="checkbox"/>	<input type="checkbox"/>	<input type="checkbox"/>
Zone			<input type="checkbox"/>	<input type="checkbox"/>	<input type="checkbox"/>	Zone			<input type="checkbox"/>	<input type="checkbox"/>	<input type="checkbox"/>
Zone			<input type="checkbox"/>	<input type="checkbox"/>	<input type="checkbox"/>	Zone			<input type="checkbox"/>	<input type="checkbox"/>	<input type="checkbox"/>
Zone			<input type="checkbox"/>	<input type="checkbox"/>	<input type="checkbox"/>	Zone			<input type="checkbox"/>	<input type="checkbox"/>	<input type="checkbox"/>
Zone			<input type="checkbox"/>	<input type="checkbox"/>	<input type="checkbox"/>	Zone			<input type="checkbox"/>	<input type="checkbox"/>	<input type="checkbox"/>
Zone			<input type="checkbox"/>	<input type="checkbox"/>	<input type="checkbox"/>	Zone			<input type="checkbox"/>	<input type="checkbox"/>	<input type="checkbox"/>
Zone			<input type="checkbox"/>	<input type="checkbox"/>	<input type="checkbox"/>	Zone			<input type="checkbox"/>	<input type="checkbox"/>	<input type="checkbox"/>
Zone			<input type="checkbox"/>	<input type="checkbox"/>	<input type="checkbox"/>	Zone			<input type="checkbox"/>	<input type="checkbox"/>	<input type="checkbox"/>
Zone			<input type="checkbox"/>	<input type="checkbox"/>	<input type="checkbox"/>	Zone			<input type="checkbox"/>	<input type="checkbox"/>	<input type="checkbox"/>
Zone			<input type="checkbox"/>	<input type="checkbox"/>	<input type="checkbox"/>	Zone			<input type="checkbox"/>	<input type="checkbox"/>	<input type="checkbox"/>
Zone			<input type="checkbox"/>	<input type="checkbox"/>	<input type="checkbox"/>	Zone			<input type="checkbox"/>	<input type="checkbox"/>	<input type="checkbox"/>
Zone			<input type="checkbox"/>	<input type="checkbox"/>	<input type="checkbox"/>	Zone			<input type="checkbox"/>	<input type="checkbox"/>	<input type="checkbox"/>

Zone Recognition

NOTE: For keypad zone programming, see *Keypad Programming* on page 7.

When expanding zones via ZX8/ZX82, up to three ZX8/ZX82 modules can be added to the system, and they are identified by the ZX8/ZX82 three-position jumpers: +1, +9, and +17. Table 3 displays zone recognition information for SP+ control panels.

NOTE: If a device is assigned to a zone which is already programmed, a wireless zone will overwrite a keypad/hardwire zone and a keypad zone will overwrite a hardwire zone.

Table 3: Zone recognition information for the SP+ series

SP5500+			SP6000+			SP6000+ (with ATZ)*			SP7000+		
Type	Zone	Description	Type	Zone	Description	Type	Zone	Description	Type	Zone	Description
Panel	1	Panel input 1	Panel	1	Panel input 1	Panel	1	Panel input 1A	Panel	1	Panel input 1
	2	Panel input 2		2	Panel input 2		2	Panel input 2A		2	Panel input 2
	3	Panel input 3		3	Panel input 3		3	Panel input 3A		3	Panel input 3
	4	Panel input 4		4	Panel input 4		4	Panel input 4A		4	Panel input 4
	5	Panel input 5		5	Panel input 5		5	Panel input 5A		5	Panel input 5
ZX8 Jumper Panel + 1	6	Input 1	ZX8 Jumper Panel + 1	6	Panel input 6	Panel	6	Panel input 6A	Panel	6	Panel input 6
	7	Input 2		7	Panel input 7		7	Panel input 7A		7	Panel input 7
	8	Input 3		8	Panel input 8		8	Panel input 8A		8	Panel input 8
	9	Input 4		9	Input 1		9	Panel input 1B		9	Panel input 9
	10	Input 5		10	Input 2		10	Panel input 2B		10	Panel input 10
	11	Input 6		11	Input 3		11	Panel input 3B		11	Panel input 11
	12	Input 7		12	Input 4		12	Panel input 4B		12	Panel input 12
	13	Input 8		13	Input 5		13	Panel input 5B		13	Panel input 13
ZX8 Jumper Panel + 9	14	Input 1	ZX8 Jumper Panel + 9	14	Input 6	ZX8/ ZX82Z X8/ ZX82 Jumper Panel + 1	14	Panel input 6B	ZX8 Jumper Panel + 9	14	Panel input 14
	15	Input 2		15	Input 7		15	Panel input 7B		15	Panel input 15
	16	Input 3		16	Input 8		16	Panel input 8B		16	Panel input 16
	17	Input 4		17	Input 1		17	Input 1		17	Input 1
	18	Input 5		18	Input 2		18	Input 2		18	Input 2
	19	Input 6		19	Input 3		19	Input 3		19	Input 3
	20	Input 7		20	Input 4		20	Input 4		20	Input 4
	21	Input 8		21	Input 5		21	Input 5		21	Input 5
ZX8 Jumper Panel + 17	22	Input 1	ZX8 Jumper Panel + 17	22	Input 6	ZX8/ ZX82 Jumper Panel + 9	22	Input 6	ZX8 Jumper Panel + 9	22	Input 6
	23	Input 2		23	Input 7		23	Input 7		23	Input 7
	24	Input 3		24	Input 8		24	Input 8		24	Input 8
	25	Input 4		25	Input 1		25	Input 1		25	Input 1
	26	Input 5		26	Input 2		26	Input 2		26	Input 2
	27	Input 6		27	Input 3		27	Input 3		27	Input 3
	28	Input 7		28	Input 4		28	Input 4		28	Input 4
	29	Input 8		29	Input 5		29	Input 5		29	Input 5
-	30	-	-	30	Input 6	-	30	Input 6	-	30	Input 6
	31	-		31	Input 7		31	Input 7		31	Input 7
	32	-		32	Input 8		32	Input 8		32	Input 8

* Please note that ATZ is only supported on the SP6000+.

Zone Definitions

NOTE: If a device is assigned to a zone which is already programmed, a wireless zone will overwrite a keypad/hardwire zone and a keypad zone will overwrite a hardwire zone.

To define zones on your SP+ control panel:

1. Press **ENTER**, and then enter your installer code (maintenance code may also be used). The **ARM** and **STAY** functions will flash.
2. Enter the three-digit zone number you wish to program (e.g., **001** to **032**). The **ARM** and **STAY** functions will remain illuminated.
3. Enter a two-digit zone definition, by referring to table 4.
4. Assign a partition, by referring to table 5. By default, all zones are assigned to partition 1.
5. Select or deselect zone options, using buttons **1** to **8** (see tables 6 and 7).
6. Press **ENTER** to save and proceed to the next zone.
7. Repeat steps 3 to 6 for all remaining zones.

Table 4: Zone definitions for SP+ Series panels

Input Value	Description	Arming Type		
		Stay Arm	Sleep Arm	Fully Arm
00	Disabled (default)	-	-	-
01	Entry delay 1	Entry delay 1	Entry delay 1	Entry delay 1
02	Entry delay 2	Entry delay 2	Entry delay 2	Entry delay 2
03	Entry delay 1 (Full Arm)	Not armed	Not armed	Entry delay 1
04	Entry delay 2 (Full Arm)	Not armed	Not armed	Entry delay 2
05	Follow	Follow*	Follow*	Follow
06	Follow (sleep/full arm)	Not armed	Follow*	Follow
07	Follow (full arm)	Not armed	Not armed	Follow
08	Instant	Instant*	Instant*	Instant
09	Instant (sleep/full arm)	Not armed	Instant*	Instant
10	Instant (full arm)	Not armed	Not armed	Instant
11	Instant fire†	-	-	-
12	Delayed fire†	-	-	-
13	Instant fire silent†	-	-	-
14	Delayed fire silent†	-	-	-
15	24 hr. buzzer	-	-	-
16	24 hr. burglary	-	-	-
17	24 hr. hold-up	-	-	-
18	24 hr. gas	-	-	-
19	24 hr. heat	-	-	-
20	24 hr. water	-	-	-
21	24 hr. freeze	-	-	-
22	24 hr. panic‡	-	-	-
23	Follow no pre-alarm	-	-	-
24	Instant no pre-alarm	-	-	-
25	Keyswitch maintain**	-	-	-
26	Keyswitch momentary**	-	-	-
33	Instant no pre-alarm (stay/sleep)	Instant	Instant	Not armed
34	Instant no pre-alarm (sleep)	Not armed	Instant	Not armed
35	Entry delay 1 (stay/full)/instant	Entry delay 1	Instant	Entry delay 1
36	Entry delay 1 (full arm)/instant	Instant	Instant	Entry delay 1

* Flex-instant: zone will follow the delay at section [720] (default is 15 seconds/0 = instant zone).

** On-board, hardwire, control panel zones only.

† ZX8/ZX82 inputs do not support fire zones. For two-wire smoke installations these definitions apply to zone 1 input only. Section [706], option 3, must be enabled. For four-wire smoke installations, use any panel, on-board zone input.

‡ This alarm will follow the panic 1 option (section [702], option 1).

Table 5: Partition assignment for SP+ Series panels

Input Value	Description
1	Assign to partition 1
2	Assign to partition 2
3	Assign to both partitions

NOTE: When using the K636 keypad, only partition 1 is available.

Table 6: Zone options for SP+ Series panels

Input Value	Description	
1	Auto zone shutdown	
2	Bypassable zone	
3	RF zone supervision	
6	Intellizone	
7	Delay alarm transmission	
8	Force zone	
Input Value	Zone Alarm Type	
4	5	
OFF	OFF	Audible alarm
OFF	ON	Pulsed alarm
ON	OFF	Silent alarm
ON	ON	Report only

NOTE: For additional zone options, see *Zone Options* on page 37.

Table 7: Keyswitch options for SP+ Series panels

Input Value	Description
1	-
2	-
3	-
4	OFF = Disarm; ON = Disarm only if Stay/Sleep armed
5	Arm only
6	Stay arming*
7	Sleep arming*
8	-

* Select only one. If all are OFF, keyswitch will regular arm.

Table 8: Permitted zone definitions

Input Value	Description	Arming Type			
		Disarm	Stay Arm	Sleep Arm	Fully Arm
00	Zone disabled	✓	✓	✓	✓
01	Entry delay 1	-	✓	✓	✓
02	Entry delay 2	-	✓	✓	✓
03	Entry delay 1 (Full Arm)	-	-	-	✓
04	Entry delay 2 (Full Arm)	-	-	-	✓
05	Follow	-	✓	✓	✓
06	Follow (sleep/full arm)	-	-	✓	✓
07	Follow (full arm)	-	-	-	✓
08	Instant	-	✓	✓	✓
09	Instant (sleep/full arm)	-	-	✓	✓
10	Instant (full arm)	-	-	-	✓
11	Instant fire	✓	✓	✓	✓
12	Delayed fire	✓	✓	✓	✓
13	Instant fire silent	✓	✓	✓	✓
14	Delayed fire silent	✓	✓	✓	✓
15	24 hr. buzzer	✓	✓	✓	✓

Input Value	Description	Arming Type			
		Disarm	Stay Arm	Sleep Arm	Fully Arm
16	24 hr. burglary	✓	✓	✓	✓
17	24 hr. hold-up	✓	✓	✓	✓
18	24 hr. gas	✓	✓	✓	✓
19	24 hr. heat	✓	✓	✓	✓
20	24 hr. water	✓	✓	✓	✓
21	24 hr. freeze	✓	✓	✓	✓
22	24 hr. panic	✓	✓	✓	✓
23	Follow no pre-alarm	-	✓	✓	✓
24	Instant no pre-alarm	-	✓	✓	✓
25	Keyswitch maintain	✓	✓	✓	✓
26	Keyswitch momentary	✓	✓	✓	✓
33	Instant no pre-alarm (stay/sleep)	-	✓	✓	-
34	Instant no pre-alarm (sleep)	-	-	✓	-
35	Entry delay 1 (stay/full)/instant	-	✓	✓	✓
36	Entry delay 1 (full arm)/instant	-	✓	✓	✓

Worksheet 7: Zone Definitions

Section	Zone	Description (see tables 3 and 4)	Zone Definition	Partition	Zone Options	Section	Zone	Description (see tables 3 and 4)	Zone Definition	Partition	Zone Options
[001]	1	_____	___/___	_____	1 2 3 4 5 6 7 8	[017]	17	_____	___/___	_____	1 2 3 4 5 6 7 8
[002]	2	_____	___/___	_____	1 2 3 4 5 6 7 8	[018]	18	_____	___/___	_____	1 2 3 4 5 6 7 8
[003]	3	_____	___/___	_____	1 2 3 4 5 6 7 8	[019]	19	_____	___/___	_____	1 2 3 4 5 6 7 8
[004]	4	_____	___/___	_____	1 2 3 4 5 6 7 8	[020]	20	_____	___/___	_____	1 2 3 4 5 6 7 8
[005]	5	_____	___/___	_____	1 2 3 4 5 6 7 8	[021]	21	_____	___/___	_____	1 2 3 4 5 6 7 8
[006]	6	_____	___/___	_____	1 2 3 4 5 6 7 8	[022]	22	_____	___/___	_____	1 2 3 4 5 6 7 8
[007]	7	_____	___/___	_____	1 2 3 4 5 6 7 8	[023]	23	_____	___/___	_____	1 2 3 4 5 6 7 8
[008]	8	_____	___/___	_____	1 2 3 4 5 6 7 8	[024]	24	_____	___/___	_____	1 2 3 4 5 6 7 8
[009]	9	_____	___/___	_____	1 2 3 4 5 6 7 8	[025]	25	_____	___/___	_____	1 2 3 4 5 6 7 8
[010]	10	_____	___/___	_____	1 2 3 4 5 6 7 8	[026]	26	_____	___/___	_____	1 2 3 4 5 6 7 8
[011]	11	_____	___/___	_____	1 2 3 4 5 6 7 8	[027]	27	_____	___/___	_____	1 2 3 4 5 6 7 8
[012]	12	_____	___/___	_____	1 2 3 4 5 6 7 8	[028]	28	_____	___/___	_____	1 2 3 4 5 6 7 8
[013]	13	_____	___/___	_____	1 2 3 4 5 6 7 8	[029]	29	_____	___/___	_____	1 2 3 4 5 6 7 8
[014]	14	_____	___/___	_____	1 2 3 4 5 6 7 8	[030]	30	_____	___/___	_____	1 2 3 4 5 6 7 8
[015]	15	_____	___/___	_____	1 2 3 4 5 6 7 8	[031]	31	_____	___/___	_____	1 2 3 4 5 6 7 8
[016]	16	_____	___/___	_____	1 2 3 4 5 6 7 8	[032]	32	_____	___/___	_____	1 2 3 4 5 6 7 8

NOTE: See worksheet 10 on page 16, for assigning wireless zones to your SP+ Series control panels.

Custom Zone Definitions

With SP+ Series control panels you can create up to four custom zone definition templates (use worksheet 8). Custom zone definition templates (sections [033] to [036]) will overwrite zone definitions 33 to 36 in table 4 on page 13. Modifications can be made in accordance with table 8 (*Permitted zone definitions*), on page 14.

Worksheet 8: Custom Zone Definitions

Section	Description	Disarm	Stay Arm	Sleep Arm	Full Arm
[033]	Zone definition template 1	___/___/___	___/___/___	___/___/___	___/___/___
[034]	Zone definition template 2	___/___/___	___/___/___	___/___/___	___/___/___
[035]	Zone definition template 3	___/___/___	___/___/___	___/___/___	___/___/___
[036]	Zone definition template 4	___/___/___	___/___/___	___/___/___	___/___/___

Zone Timers

Use the following section to program zone timers for your SP+ Series control panels. Use worksheets 9 and 10 to record your settings.

NOTE: When both ATZ (SP6000+ only) and EOL are enabled, the zone speed should not be set below 300 msec.

Worksheet 9: Timers

Section	Zone	SP5500+	SP6000+	SP7000+	Data	Description (default: 060)
[041]	1	(Z1)	(Z1)	(Z1)	___/___/___ (000 to 255) x 10 msec.	Speed of hardwire zone 1
[042]	2	(Z2)	(Z2)	(Z2)	___/___/___ (000 to 255) x 10 msec.	Speed of hardwire zone 2
[043]	3	(Z3)	(Z3)	(Z3)	___/___/___ (000 to 255) x 10 msec.	Speed of hardwire zone 3
[044]	4	(Z4)	(Z4)	(Z4)	___/___/___ (000 to 255) x 10 msec.	Speed of hardwire zone 4
[045]	5	(Z5)	(Z5)	(Z5)	___/___/___ (000 to 255) x 10 msec.	Speed of hardwire zone 5
[046]	6		(Z6)	(Z6)	___/___/___ (000 to 255) x 10 msec.	Speed of hardwire zone 6
[047]	7		(Z7)	(Z7)	___/___/___ (000 to 255) x 10 msec.	Speed of hardwire zone 7
[048]	8		(Z8)	(Z8)	___/___/___ (000 to 255) x 10 msec.	Speed of hardwire zone 8
[049]	9		(Z1 ATZ)	(Z9)	___/___/___ (000 to 255) x 10 msec.	Speed of hardwire zone 9
[050]	10		(Z2 ATZ)	(Z10)	___/___/___ (000 to 255) x 10 msec.	Speed of hardwire zone 10
[051]	11		(Z3 ATZ)	(Z11)	___/___/___ (000 to 255) x 10 msec.	Speed of hardwire zone 11
[052]	12		(Z4 ATZ)	(Z12)	___/___/___ (000 to 255) x 10 msec.	Speed of hardwire zone 12
[053]	13		(Z5 ATZ)	(Z13)	___/___/___ (000 to 255) x 10 msec.	Speed of hardwire zone 13
[054]	14		(Z6 ATZ)	(Z14)	___/___/___ (000 to 255) x 10 msec.	Speed of hardwire zone 14
[055]	15		(Z7 ATZ)	(Z15)	___/___/___ (000 to 255) x 10 msec.	Speed of hardwire zone 15
[056]	16		(Z8 ATZ)	(Z16)	___/___/___ (000 to 255) x 10 msec.	Speed of hardwire zone 16

Wireless Zone Assignment

Use the following section to program the wireless zones on your SP+ Series control panels. Use worksheet 10 to record your settings.

Worksheet 10: Wireless Zones

Section	Zone	Wireless Zone (Serial #)	Section	Zone	Wireless Zone (Serial #)	Section	Zone	Wireless Zone (Serial #)
[061]	1	___/___/___/___/___	[072]	12	___/___/___/___/___	[083]	23	___/___/___/___/___
[062]	2	___/___/___/___/___	[073]	13	___/___/___/___/___	[084]	24	___/___/___/___/___
[063]	3	___/___/___/___/___	[074]	14	___/___/___/___/___	[085]	25	___/___/___/___/___
[064]	4	___/___/___/___/___	[075]	15	___/___/___/___/___	[086]	26	___/___/___/___/___
[065]	5	___/___/___/___/___	[076]	16	___/___/___/___/___	[087]	27	___/___/___/___/___
[066]	6	___/___/___/___/___	[077]	17	___/___/___/___/___	[088]	28	___/___/___/___/___
[067]	7	___/___/___/___/___	[078]	18	___/___/___/___/___	[089]	29	___/___/___/___/___
[068]	8	___/___/___/___/___	[079]	19	___/___/___/___/___	[090]	30	___/___/___/___/___
[069]	9	___/___/___/___/___	[080]	20	___/___/___/___/___	[091]	31	___/___/___/___/___
[070]	10	___/___/___/___/___	[081]	21	___/___/___/___/___	[092]	32	___/___/___/___/___
[071]	11	___/___/___/___/___	[082]	22	___/___/___/___/___			

NOTE: When assigning wireless zones, enter the serial number, or press **TAMPER/LEARN**; for the 2WPGM, remove and re-install Jumper 2 (JP2). To delete the serial number, enter **00000**.

Wireless Transmitter Signal Strength

The signal strength test for wireless transmitters is performed in sections [101] to [132]; these sections represent zones 1 to 32, respectively. To test the wireless transmitter strength of your various wireless devices, proceed as follows:

1. Enter the zone's respective section (e.g., for zone 1, enter section [101]).
2. For all wireless transmitters except 2WPGM: Press the transmitter's anti-tamper switch and note the number of beeps which are emitted. As shown in table 9, the number of beeps correspond to a preset signal strength range.
For the 2WPGM: Remove and re-install Jumper 2 (JP2).

Table 9: Signal strength indicator for wireless transmitters

Number of Beeps	Signal Strength	Result
3	8 to 10	Strong signal
2	5 to 7	Average signal
1	1 to 4	Weak signal (relocate)

NOTE: The visual representation of a transmitter's signal strength is dependent on the type of keypad. For LED keypads, zones 1 through 10 will illuminate, depending on the signal strength. For instance, a signal strength of 8 will result in zones 1 through 8 to illuminate. For LCD keypads, a ten-level progress bar composed of arrows will appear, followed by the numeric value. For a signal strength of 8, eight arrows will appear, followed by the number 8.

Zone Report Codes and Labels

Use the following section to program zone report codes and labels on your SP+ Series control panels.

Zone Report Codes

Use worksheet 11 to record your settings when programming zone report codes.

Worksheet 11: Zone Report Codes

Section	Zone	Alarm Report Codes	Alarm Restore Report Codes	Tamper Report Codes	Tamper Restore Report Codes	Section	Zone	Alarm Report Codes	Alarm Restore Report Codes	Tamper Report Codes	Tamper Restore Report Codes
[141]	1	___/___	___/___	___/___	___/___	[157]	17	___/___	___/___	___/___	___/___
[142]	2	___/___	___/___	___/___	___/___	[158]	18	___/___	___/___	___/___	___/___
[143]	3	___/___	___/___	___/___	___/___	[159]	19	___/___	___/___	___/___	___/___
[144]	4	___/___	___/___	___/___	___/___	[160]	20	___/___	___/___	___/___	___/___
[145]	5	___/___	___/___	___/___	___/___	[161]	21	___/___	___/___	___/___	___/___
[146]	6	___/___	___/___	___/___	___/___	[162]	22	___/___	___/___	___/___	___/___
[147]	7	___/___	___/___	___/___	___/___	[163]	23	___/___	___/___	___/___	___/___
[148]	8	___/___	___/___	___/___	___/___	[164]	24	___/___	___/___	___/___	___/___
[149]	9	___/___	___/___	___/___	___/___	[165]	25	___/___	___/___	___/___	___/___
[150]	10	___/___	___/___	___/___	___/___	[166]	26	___/___	___/___	___/___	___/___
[151]	11	___/___	___/___	___/___	___/___	[167]	27	___/___	___/___	___/___	___/___
[152]	12	___/___	___/___	___/___	___/___	[168]	28	___/___	___/___	___/___	___/___
[153]	13	___/___	___/___	___/___	___/___	[169]	29	___/___	___/___	___/___	___/___
[154]	14	___/___	___/___	___/___	___/___	[170]	30	___/___	___/___	___/___	___/___
[155]	15	___/___	___/___	___/___	___/___	[171]	31	___/___	___/___	___/___	___/___
[156]	16	___/___	___/___	___/___	___/___	[172]	32	___/___	___/___	___/___	___/___

Zone Labels

Use worksheet 12 to record your settings when programming zone labels.

Worksheet 12: Zone Labels

Section	Zone	Zone Label	Section	Zone	Zone Label
[181]	1	_____	[197]	17	_____
[182]	2	_____	[198]	18	_____
[183]	3	_____	[199]	19	_____
[184]	4	_____	[200]	20	_____
[185]	5	_____	[201]	21	_____
[186]	6	_____	[202]	22	_____
[187]	7	_____	[203]	23	_____
[188]	8	_____	[204]	24	_____
[189]	9	_____	[205]	25	_____
[190]	10	_____	[206]	26	_____
[191]	11	_____	[207]	27	_____
[192]	12	_____	[208]	28	_____
[193]	13	_____	[209]	29	_____
[194]	14	_____	[210]	30	_____
[195]	15	_____	[211]	31	_____
[196]	16	_____	[212]	32	_____

Programmable Output Programming

Use the following section to program programmable outputs (PGMs) on your SP+ Series control panel.

Programmable Output Recognition

Worksheet 13: Programmable outputs for SP+ Series control panels

PGM	PGM Output	Control Panel		
		SP5500+	SP6000+	SP7000+
1	Control panel output 1	✓	✓	✓
2	Control panel output 2	✓	✓	✓
3	Control panel output 3	-	Optional	✓
4	Control panel output 4	-	Optional	✓
5	Control panel relay	-	Optional	✓
6	ZX8/ZX82 ID = 1 output	✓	✓	✓
7	ZX8/ZX82 ID = 2 output	✓	✓	✓
8	ZX8/ZX82 ID = 3 output	✓	✓	-
9	PGM4/PGM82 relay 1	✓	✓	✓
10	PGM4 /PGM82 relay 2	✓	✓	✓
11	PGM4/PGM82 relay 3	✓	✓	✓
12	PGM4/PGM82 relay 4	✓	✓	✓
13	RTX3/RX1 output 1	✓	✓	✓
14	RTX3/RX1 output 2	✓	✓	✓
15	RTX3 output 3 (relay)	✓	✓	✓
16	RTX3 output 4 (relay)	Optional	Optional	Optional

NOTE: A wireless PGM module can be assigned to any PGM. These modules will work in parallel with the control panel output.

Programmable Output on the K32LCD/K32LX

The on-board PGM of the K32LCD and K32LX (not programmable) will follow the arm status of any partition, via any arming method, including StayD.

Description of Events

Table 10: List of events

Event Group	Event Group Description	Sub-group	Sub-group Description
00	Zone OK	01 to 32	Zone number
01	Zone open	99	Any zone number
02	Partition status	00 to 01	-
		02	Silent alarm
		03	Buzzer alarm
		04	Steady alarm
		05	Pulsed alarm
		06	Strobe
		07	Alarm stopped
		08	Squawk ON (partition 1 only)
		09	Squawk OFF (partition 1 only)
		10	Ground start (partition 1 only)
		11	Disarm partition
		12	Arm partition
		13	Entry delay started
		14	Exit delay started
		15	Pre-alarm delay
		16	Report confirmation
		99	Any partition status event
03	Bell status (partition 1 only)	00	Bell OFF
		01	Bell ON
		02	Bell squawk arm
		03	Bell squawk disarm
		99	Any bell status event
06	Non-reportable event	00	Telephone line trouble
		01	CLEAR + ENTER , or  was pressed for 3 secs. (partition 1 only)
		02	-
		03	Arm in Stay mode
		04	Arm in Sleep mode
		05	Arm in Force mode
		06	Full arm when armed in Stay mode
		07	PC fail to communicate (partition 1 only)
		08	Utility key 1 pressed (keys 1 and 2 ; partition 1 only)
		09	Utility key 2 pressed (keys 4 and 5 ; partition 1 only)
		10	Utility key 3 pressed (keys 7 and 8 ; partition 1 only)
		11	Utility key 4 pressed (keys 2 and 3 ; partition 1 only)
		12	Utility key 5 pressed (keys 5 and 6 ; partition 1 only)
		13	Utility key 6 pressed (keys 8 and 9 ; partition 1 only)
		14	Tamper generated alarm
		15	Supervision loss generated alarm
		16	-
		17	-
		18	-
		19	-
		20	Full arm when armed in Sleep mode
		21	Firmware upgrade (partition 1 only; non-PGM event)
		22	-
		23	StayD mode activated
24	StayD mode deactivated		

Table 10: List of events

Event Group	Event Group Description	Sub-group	Sub-group Description
06 (Cont.)	Non-reportable event (Cont.)	25	IP registration status change
		26	GPRS registration status change
		27	Armed with trouble(s)
		28	Supervision alert
		29	Supervision alert restore
		30	Armed with remote with low battery
		99	Any non-reportable event
08	Button pressed on remote (see <i>Default Data B</i> , in worksheet 26 on page 34)	01 to 32	Remote control number
		99	Any remote control number
09	Button pressed on remote (see <i>Default Data C</i> , in worksheet 26 on page 34)	01 to 32	Remote control number
		99	Any remote control number
10	Button pressed on remote (see <i>Default Data D</i> , in worksheet 26 on page 34)	01 to 32	Remote control number
		99	Any remote control number
11	Button pressed on remote (see <i>Default Data E</i> , in worksheet 26 on page 34)	01 to 32	Remote control number
		99	Any remote control number
12	Cold start wireless zone	01 to 32	Zone number
		99	Any zone number
13	Cold start wireless module (partition 1 only)	01 to 16	Output number
		17 to 18	Wireless repeater
		19 to 26	Wireless keypad
		27 to 30	Wireless siren
		99	Any output number
14	Bypass programming	01 to 32	User number
		99	Any user number
15	User code activated output (partition 1 only)	01 to 32	User number
		99	Any user number
16	Wireless smoke maintenance signal	01 to 32	Zone number
		99	Any zone number
17	Delay zone alarm transmission	01 to 32	Zone number
		99	Any zone number
18	Zone signal strength weak 1 (partition 1 only)	01 to 32	Zone number
		99	Any zone number
19	Zone signal strength weak 2 (partition 1 only)	01 to 32	Zone number
		99	Any zone number
20	Zone signal strength weak 3 (partition 1 only)	01 to 32	Zone number
		99	Any zone number
21	Zone signal strength weak 4 (partition 1 only)	01 to 32	Zone number
		99	Any zone number
22	Button pressed on remote (see option 5, in table 21 on page 33)	01 to 32	Remote control number
		99	Any remote control number
23	Button pressed on remote (see option 6, in table 21 on page 33)	01 to 32	Remote control number
		99	Any remote control number
24	Fire delay started	01 to 32	Zone number
		99	Any zone number

Table 10: List of events

Event Group	Event Group Description	Sub-group	Sub-group Description
25	-	-	-
26	Software access (VDMP3, IP Module, BabyWare)	00	Non-valid source ID
		01	BabyWare direct
		02	BabyWare through IP module
		03	BabyWare through PCS module
		04	BabyWare through modem
		09	IP Module direct
		10	VDMP3 direct
		11	N/A
		12	Remote access
		13	SMS through PCS module
		99	Any software access
27	Bus module event	00	A bus module was added
		01	A bus module was removed
		02	2-way RF module communication failure
		03	2-way RF module communication restored
		99	Any bus module event
28	StayD pass acknowledged	01 to 32	Zone number
		99	Any zone number
29	Arming with user	01 to 32	User number
		99	Any user number
30	Special arming	00	Auto-arming (on-time/no movement)
		01	Late to close
		02	No movement arming
		03	Partial arming
		04	Quick arming
		05	Arming through BabyWare
		06	Arming with keyswitch
		99	Any special arming
31	Disarming with user	01 to 32	User number
		99	Any user number
32	Disarming after an alarm with user	01 to 32	User number
		99	Any user number
33	Alarm cancelled with user	01 to 32	User number
		99	Any user number
34	Special disarming	00	Auto-arm cancelled (on-time/no movement)
		01	Disarming through BabyWare
		02	Disarming through BabyWare after alarm
		03	Alarm cancelled through BabyWare
		04	Paramedical alarm cancelled
		05	Disarm with keyswitch
		06	Disarm with keyswitch after an alarm
		07	Alarm cancelled with keyswitch
		99	Any special disarming
35	Zone bypassed	01 to 32	Zone number
		99	Any zone number
36	Zone in alarm	01 to 32	Zone number
		99	Any zone number
37	Fire alarm	01 to 32	Zone number
		99	Any zone number

Table 10: List of events

<i>Event Group</i>	<i>Event Group Description</i>	<i>Sub-group</i>	<i>Sub-group Description</i>
38	Zone alarm restore	01 to 32	Zone number
		99	Any zone number
39	Fire alarm restore	01 to 32	Zone number
		99	Any zone number
40	Special alarm	00	Panic non-medical emergency
		01	Panic medical
		02	Panic fire
		03	Recent closing
		04	Global shutdown
		05	Duress alarm
		06	Keypad lockout (partition 1 only)
		99	Any special alarm event
41	Zone shutdown	01 to 32	Zone number
		99	Any zone number
42	Zone tampered	01 to 32	Zone number
		99	Any zone number
43	Zone tamper restore	01 to 32	Zone number
		99	Any zone number

Table 10: List of events

Event Group	Event Group Description	Sub-group	Sub-group Description
44	New trouble (partition 1 only, except sub-group 07, which is for both partitions)	00	-
		01	AC failure
		02	Battery failure
		03	Auxiliary current overload
		04	Bell current overload
		05	Bell disconnected
		06	Clock loss
		07	Fire loop trouble
		08	Fail to communicate with monitoring station telephone # 1
		09	Fail to communicate with monitoring station telephone # 2
		11	Fail to communicate with voice report
		12	RF jamming
		13	PCS RF jamming
		14	N/A
		15	N/A
		16	Fail to communicate IP receiver 1 (GPRS)
		17	Fail to communicate IP receiver 2 (GPRS)
		18	IP module no service
		19	IP module supervision loss
		20	Fail to communicate IP receiver 1 (IP)
		21	Fail to communicate IP receiver 2 (IP)
		22	GPRS module tamper trouble
		99	Any new trouble event
45	Trouble restored	00	Telephone line restored
		01	AC failure restore
		02	Battery failure restore
		03	Auxiliary current overload
		04	Bell current overload restore
		05	Bell disconnected restore
		06	Clock loss restore
		07	Fire loop trouble restore
		08	Fail to communicate with monitoring station tel. # 1 restore
		09	Fail to communicate with monitoring station tel. # 2 restore
		11	Fail to communicate with voice report restore
		12	RF jamming restore
		13	PCS RF jamming restore
		14	N/A
		15	N/A
		16	Fail to communicate restore IP receiver 1 (GPRS)
		17	Fail to communicate restore IP receiver 2 (GPRS)
		18	IP module no service restore
		19	IP module supervision loss restore
		20	Fail to communicate restore IP receiver 1 (IP)
		21	Fail to communicate restore IP receiver 2 (IP)
		22	GPRS module tamper trouble restore
		99	Any new trouble restored event

Table 10: List of events

Event Group	Event Group Description	Sub-group	Sub-group Description
46	Bus/EBus/wireless module new trouble (partition 1 only)	00	Bus/EBus/wireless module communication fault
		01	Tamper trouble
		02	Power fail
		03	Battery failure
		99	Any bus module new trouble event
47	Bus/EBus/wireless module trouble restored (partition 1 only)	00	Bus/EBus/wireless module communication fault restore
		01	Tamper trouble restore
		02	Power fail restore
		03	Battery failure restore
		99	Any bus module new trouble restored event
48	Special (partition1 only)	00	System power up
		01	Reporting test
		02	Software log on
		03	Software log off
		04	Installer in programming mode
		05	Installer exited programming mode
		06	Maintenance in programming mode
		07	Maintenance exited programming mode
		08	Closing delinquency delay elapsed
		13	Failed to arm
		99	Any special event
49	Low battery on zone	01 to 32	Zone number
		99	Any zone number
50	Low battery on zone restore	01 to 32	Zone number
		99	Any zone number
51	Zone supervision trouble	01 to 32	Zone number
		99	Any zone number
52	Zone supervision restore	01 to 32	Zone number
		99	Any zone number
53	Wireless module supervision trouble (partition 1 only)	01 to 16	Output
		17 to 18	Wireless repeater
		19 to 22	Wireless keypad
		27 to 30	Wireless siren
		99	Any output number
54	Wireless module supervision restore (partition 1 only)	01 to 16	Output
		17 to 18	Wireless repeater
		19 to 22	Wireless keypad
		27 to 30	Wireless siren
		99	Any output number
55	Wireless module tamper trouble (partition 1 only)	01 to 16	Output
		17 to 18	Wireless repeater
		19 to 22	Wireless keypad
		27 to 30	Wireless siren
		99	Any output number
56	Wireless module tamper restore (partition 1 only)	01 to 16	Output
		17 to 18	Wireless repeater
		19 to 22	Wireless keypad
		27 to 30	Wireless siren
		99	Any output number

Table 10: List of events

Event Group	Event Group Description	Sub-group	Sub-group Description
57	Non-medical alarm (paramedic)	01 to 32	User number
		99	Any user number
58	Zone forced	01 to 32	Zone number
		99	Any zone number
59	Zone included	01 to 32	Zone number
	Zone included (Cont.)	99	Any zone number
60	Remote low battery	01 to 32	User number
		99	Any user number
61	Remote low battery restore	01 to 32	User number
		99	Any user number
64	System status (on-board PGMs only)	00	Follow ARM LED status*: PGM pulse fast in alarm PGM pulse fast in exit delay, below 10 sec. PGM pulse slow in exit delay, over 10 sec. PGM steady ON, if armed PGM OFF, if disarmed * This event can be assigned to partition 1 or 2. If assigned to both partitions, the PGM event will follow the list order above, with number 1 being the highest priority.

PGM Activation/Deactivation Events

Use worksheet 14 to record your settings for the SP+ Series PGM events. See table 10 on page 18, for a list of these events.

Worksheet 14: PGM Activation/Deactivation Events

Section	PGM	Event	Event Group	Sub-group	Partition (99 for both)	Default	Section	PGM	Event	Event Group	Sub-group	Partition (99 for both)	Default
[220]	PGM 1	Activation	___	___	___	08/99/99*	[236]	PGM 9	Activation	___	___	___	00/00/00
[221]		Deactivation	___	___	___	00/00/00	[237]		Deactivation	___	___	___	00/00/00
[222]	PGM 2	Activation	___	___	___	09/99/99**	[238]	PGM 10	Activation	___	___	___	00/00/00
[223]		Deactivation	___	___	___	00/00/00	[239]		Deactivation	___	___	___	00/00/00
[224]	PGM 3	Activation	___	___	___	00/00/00	[240]	PGM 11	Activation	___	___	___	00/00/00
[225]		Deactivation	___	___	___	00/00/00	[241]		Deactivation	___	___	___	00/00/00
[226]	PGM 4	Activation	___	___	___	00/00/00	[242]	PGM 12	Activation	___	___	___	00/00/00
[227]		Deactivation	___	___	___	00/00/00	[243]		Deactivation	___	___	___	00/00/00
[228]	PGM 5	Activation	___	___	___	00/00/00	[244]	PGM 13	Activation	___	___	___	08/99/01
[229]		Deactivation	___	___	___	00/00/00	[245]		Deactivation	___	___	___	08/99/01
[230]	PGM 6	Activation	___	___	___	00/00/00	[246]	PGM 14	Activation	___	___	___	09/99/01
[231]		Deactivation	___	___	___	00/00/00	[247]		Deactivation	___	___	___	09/99/01
[232]	PGM 7	Activation	___	___	___	00/00/00	[248]	PGM 15	Activation	___	___	___	00/00/00
[233]		Deactivation	___	___	___	00/00/00	[249]		Deactivation	___	___	___	00/00/00
[234]	PGM 8	Activation	___	___	___	00/00/00	[250]	PGM 16	Activation	___	___	___	00/00/00
[235]		Deactivation	___	___	___	00/00/00	[251]		Deactivation	___	___	___	00/00/00

* Section [220], PGM 1 activation event: default = option B remote assignment. Button pressed on any remote/any partition (see table 21 on page 33).

** Section [222], PGM 2 activation event: default = option C remote assignment. Button pressed on any remote/any partition (see table 21 on page 33).

PGM Options

Table 11: Description of PGM options

Option	Description	PGM 1 [261]		PGM 2 [262]		PGM 3 [263]		PGM 4 [264]		PGM 5 [265]		PGM 6 [266]		PGM 7 [267]		PGM 8 [268]	
		OFF	ON	OFF	ON	OFF	ON	OFF	ON	OFF	ON	OFF	ON	OFF	ON	OFF	ON
1	PGM base time (OFF = sec., ON = min.)	<input type="checkbox"/>	<input checked="" type="checkbox"/>	<input type="checkbox"/>	<input checked="" type="checkbox"/>	<input type="checkbox"/>	<input checked="" type="checkbox"/>	<input type="checkbox"/>	<input checked="" type="checkbox"/>	<input type="checkbox"/>	<input checked="" type="checkbox"/>	<input type="checkbox"/>	<input checked="" type="checkbox"/>	<input type="checkbox"/>	<input checked="" type="checkbox"/>	<input type="checkbox"/>	<input checked="" type="checkbox"/>
2	PGM state (OFF = N.O.; ON = N.C.)	<input checked="" type="checkbox"/>	<input type="checkbox"/>	<input checked="" type="checkbox"/>	<input type="checkbox"/>	<input checked="" type="checkbox"/>	<input type="checkbox"/>	<input checked="" type="checkbox"/>	<input type="checkbox"/>	<input checked="" type="checkbox"/>	<input type="checkbox"/>	<input checked="" type="checkbox"/>	<input type="checkbox"/>	<input checked="" type="checkbox"/>	<input type="checkbox"/>	<input checked="" type="checkbox"/>	<input type="checkbox"/>
3	PGM supervision	<input type="checkbox"/>	<input checked="" type="checkbox"/>	<input type="checkbox"/>	<input checked="" type="checkbox"/>	<input type="checkbox"/>	<input checked="" type="checkbox"/>	<input type="checkbox"/>	<input checked="" type="checkbox"/>	<input type="checkbox"/>	<input checked="" type="checkbox"/>	<input type="checkbox"/>	<input checked="" type="checkbox"/>	<input type="checkbox"/>	<input checked="" type="checkbox"/>	<input type="checkbox"/>	<input checked="" type="checkbox"/>
4	PGM activation mode (OFF = steady; ON = pulse)	<input checked="" type="checkbox"/>	<input type="checkbox"/>	<input checked="" type="checkbox"/>	<input type="checkbox"/>	<input checked="" type="checkbox"/>	<input type="checkbox"/>	<input checked="" type="checkbox"/>	<input type="checkbox"/>	<input checked="" type="checkbox"/>	<input type="checkbox"/>	<input checked="" type="checkbox"/>	<input type="checkbox"/>	<input checked="" type="checkbox"/>	<input type="checkbox"/>	<input checked="" type="checkbox"/>	<input type="checkbox"/>
5	PGM pulse once every 30 seconds, if armed	<input checked="" type="checkbox"/>	<input type="checkbox"/>	<input checked="" type="checkbox"/>	<input type="checkbox"/>	<input checked="" type="checkbox"/>	<input type="checkbox"/>	<input checked="" type="checkbox"/>	<input type="checkbox"/>	<input checked="" type="checkbox"/>	<input type="checkbox"/>	<input checked="" type="checkbox"/>	<input type="checkbox"/>	<input checked="" type="checkbox"/>	<input type="checkbox"/>	<input checked="" type="checkbox"/>	<input type="checkbox"/>
6	PGM pulse on any alarm	<input checked="" type="checkbox"/>	<input type="checkbox"/>	<input checked="" type="checkbox"/>	<input type="checkbox"/>	<input checked="" type="checkbox"/>	<input type="checkbox"/>	<input checked="" type="checkbox"/>	<input type="checkbox"/>	<input checked="" type="checkbox"/>	<input type="checkbox"/>	<input checked="" type="checkbox"/>	<input type="checkbox"/>	<input checked="" type="checkbox"/>	<input type="checkbox"/>	<input checked="" type="checkbox"/>	<input type="checkbox"/>
7	PGM pulse on any alarm (OFF = partition 1; ON = partition 2)	<input checked="" type="checkbox"/>	<input type="checkbox"/>	<input checked="" type="checkbox"/>	<input type="checkbox"/>	<input checked="" type="checkbox"/>	<input type="checkbox"/>	<input checked="" type="checkbox"/>	<input type="checkbox"/>	<input checked="" type="checkbox"/>	<input type="checkbox"/>	<input checked="" type="checkbox"/>	<input type="checkbox"/>	<input checked="" type="checkbox"/>	<input type="checkbox"/>	<input checked="" type="checkbox"/>	<input type="checkbox"/>
8	Flexible PGM deactivation option (OFF ¹ = PGM delay only, two activation events; ON = PGM delay or deactivation event, whichever comes first)	<input checked="" type="checkbox"/>	<input type="checkbox"/>	<input checked="" type="checkbox"/>	<input type="checkbox"/>	<input checked="" type="checkbox"/>	<input type="checkbox"/>	<input checked="" type="checkbox"/>	<input type="checkbox"/>	<input checked="" type="checkbox"/>	<input type="checkbox"/>	<input checked="" type="checkbox"/>	<input type="checkbox"/>	<input checked="" type="checkbox"/>	<input type="checkbox"/>	<input checked="" type="checkbox"/>	<input type="checkbox"/>

Option	Description	PGM 9 [269]		PGM 10 [270]		PGM 11 [271]		PGM 12 [272]		PGM 13 [273]		PGM 14 [274]		PGM 15 [275]		PGM 16 [276]	
		OFF	ON	OFF	ON	OFF	ON	OFF	ON	OFF	ON	OFF	ON	OFF	ON	OFF	ON
1	PGM base time (OFF = sec., ON = min.)	<input type="checkbox"/>	<input checked="" type="checkbox"/>	<input type="checkbox"/>	<input checked="" type="checkbox"/>	<input type="checkbox"/>	<input checked="" type="checkbox"/>	<input type="checkbox"/>	<input checked="" type="checkbox"/>	<input type="checkbox"/>	<input checked="" type="checkbox"/>	<input type="checkbox"/>	<input checked="" type="checkbox"/>	<input type="checkbox"/>	<input checked="" type="checkbox"/>	<input type="checkbox"/>	<input checked="" type="checkbox"/>
2	PGM state (OFF = N.O.; ON = N.C.)	<input checked="" type="checkbox"/>	<input type="checkbox"/>	<input checked="" type="checkbox"/>	<input type="checkbox"/>	<input checked="" type="checkbox"/>	<input type="checkbox"/>	<input checked="" type="checkbox"/>	<input type="checkbox"/>	<input checked="" type="checkbox"/>	<input type="checkbox"/>	<input checked="" type="checkbox"/>	<input type="checkbox"/>	<input checked="" type="checkbox"/>	<input type="checkbox"/>	<input checked="" type="checkbox"/>	<input type="checkbox"/>
3	PGM supervision	<input type="checkbox"/>	<input checked="" type="checkbox"/>	<input type="checkbox"/>	<input checked="" type="checkbox"/>	<input type="checkbox"/>	<input checked="" type="checkbox"/>	<input type="checkbox"/>	<input checked="" type="checkbox"/>	<input type="checkbox"/>	<input checked="" type="checkbox"/>	<input type="checkbox"/>	<input checked="" type="checkbox"/>	<input type="checkbox"/>	<input checked="" type="checkbox"/>	<input type="checkbox"/>	<input checked="" type="checkbox"/>
4	PGM activation mode (OFF = steady; ON = pulse)	<input checked="" type="checkbox"/>	<input type="checkbox"/>	<input checked="" type="checkbox"/>	<input type="checkbox"/>	<input checked="" type="checkbox"/>	<input type="checkbox"/>	<input checked="" type="checkbox"/>	<input type="checkbox"/>	<input checked="" type="checkbox"/>	<input type="checkbox"/>	<input checked="" type="checkbox"/>	<input type="checkbox"/>	<input checked="" type="checkbox"/>	<input type="checkbox"/>	<input checked="" type="checkbox"/>	<input type="checkbox"/>
5	PGM pulse once every 30 seconds, if armed	<input checked="" type="checkbox"/>	<input type="checkbox"/>	<input checked="" type="checkbox"/>	<input type="checkbox"/>	<input checked="" type="checkbox"/>	<input type="checkbox"/>	<input checked="" type="checkbox"/>	<input type="checkbox"/>	<input checked="" type="checkbox"/>	<input type="checkbox"/>	<input checked="" type="checkbox"/>	<input type="checkbox"/>	<input checked="" type="checkbox"/>	<input type="checkbox"/>	<input checked="" type="checkbox"/>	<input type="checkbox"/>
6	PGM pulse on any alarm	<input checked="" type="checkbox"/>	<input type="checkbox"/>	<input checked="" type="checkbox"/>	<input type="checkbox"/>	<input checked="" type="checkbox"/>	<input type="checkbox"/>	<input checked="" type="checkbox"/>	<input type="checkbox"/>	<input checked="" type="checkbox"/>	<input type="checkbox"/>	<input checked="" type="checkbox"/>	<input type="checkbox"/>	<input checked="" type="checkbox"/>	<input type="checkbox"/>	<input checked="" type="checkbox"/>	<input type="checkbox"/>
7	PGM pulse on any alarm (OFF = partition 1; ON = partition 2)	<input checked="" type="checkbox"/>	<input type="checkbox"/>	<input checked="" type="checkbox"/>	<input type="checkbox"/>	<input checked="" type="checkbox"/>	<input type="checkbox"/>	<input checked="" type="checkbox"/>	<input type="checkbox"/>	<input checked="" type="checkbox"/>	<input type="checkbox"/>	<input checked="" type="checkbox"/>	<input type="checkbox"/>	<input checked="" type="checkbox"/>	<input type="checkbox"/>	<input checked="" type="checkbox"/>	<input type="checkbox"/>
8	Flexible PGM deactivation option (OFF ¹ = PGM delay only, two activation events; ON = PGM delay or deactivation event, whichever comes first)	<input checked="" type="checkbox"/>	<input type="checkbox"/>	<input checked="" type="checkbox"/>	<input type="checkbox"/>	<input checked="" type="checkbox"/>	<input type="checkbox"/>	<input checked="" type="checkbox"/>	<input type="checkbox"/>	<input checked="" type="checkbox"/>	<input type="checkbox"/>	<input checked="" type="checkbox"/>	<input type="checkbox"/>	<input checked="" type="checkbox"/>	<input type="checkbox"/>	<input checked="" type="checkbox"/>	<input type="checkbox"/>

▲ = Default Setting

¹ If a PGM delay is programmed (OFF option), the deactivation event can be used as a second activation event.

Section [277] for SP5500+ / SP6000+

Table 12: Description of section [277] for SP5500+ / SP6000+

Option	Option Type	Description	[277]	
			OFF	ON
1	Voltage output (OFF = negative trigger, 0V; ON = positive trigger, 12V)	PGM 1	<input checked="" type="checkbox"/>	<input type="checkbox"/>
2		PGM 2	<input checked="" type="checkbox"/>	<input type="checkbox"/>
3		PGM 3	<input checked="" type="checkbox"/>	<input type="checkbox"/>

▲ = Default Setting

Section [277] for SP7000+

Table 13: Description of section [277] for SP7000+

Option	Option Type	Description	[277]	
			OFF	ON
1	Voltage output (OFF = negative trigger, 0V; ON = positive trigger, 12V)	PGM 1	<input checked="" type="checkbox"/>	n
2		PGM 2	<input checked="" type="checkbox"/>	n
3		PGM 3	<input checked="" type="checkbox"/>	n
4		PGM 4	<input checked="" type="checkbox"/>	n

▲ = Default Setting

PGM Delays

Use worksheet 15 to record your settings for the SP+ Series PGM delays.

Worksheet 15: PGM Delays

Section	PGM	PGM Delay Value	Default	Section	PGM	PGM Delay Value	Default
[281]	PGM 1	___/___/___ (001 to 255 x 1 sec./min.)	015	[289]	PGM 9	___/___/___ (001 to 255 x 1 sec./min.)	015
[282]	PGM 2	___/___/___ (001 to 255 x 1 sec./min.)	015	[290]	PGM 10	___/___/___ (001 to 255 x 1 sec./min.)	015
[283]	PGM 3	___/___/___ (001 to 255 x 1 sec./min.)	015	[291]	PGM 11	___/___/___ (001 to 255 x 1 sec./min.)	015
[284]	PGM 4	___/___/___ (001 to 255 x 1 sec./min.)	015	[292]	PGM 12	___/___/___ (001 to 255 x 1 sec./min.)	015
[285]	PGM 5	___/___/___ (001 to 255 x 1 sec./min.)	015	[293]	PGM 13	___/___/___ (001 to 255 x 1 sec./min.)	015
[286]	PGM 6	___/___/___ (001 to 255 x 1 sec./min.)	015	[294]	PGM 14	___/___/___ (001 to 255 x 1 sec./min.)	015
[287]	PGM 7	___/___/___ (001 to 255 x 1 sec./min.)	015	[295]	PGM 15	___/___/___ (001 to 255 x 1 sec./min.)	015
[288]	PGM 8	___/___/___ (001 to 255 x 1 sec./min.)	015	[296]	PGM 16	___/___/___ (001 to 255 x 1 sec./min.)	015

NOTE: To change the base time (minutes or seconds), see *PGM Options* on page 25.

PGM Serial Numbers

Use worksheet 16 to record your settings for the SP+ PGM serial numbers. To delete a wireless PGM, enter **000000**, while in the PGM's respective section. For automatic assignment, press the **LEARN/TAMPER** switch or remove and re-install Jumper 2 (JP2) on the wireless PGM, while in the PGM's respective section.

Worksheet 16: PGM Serial Numbers

Section	PGM	Wireless PGM Serial Number	Section	PGM	Wireless PGM Serial Number
[301]	PGM 1	___/___/___/___/___/___	[309]	PGM 9	___/___/___/___/___/___
[302]	PGM 2	___/___/___/___/___/___	[310]	PGM 10	___/___/___/___/___/___
[303]	PGM 3	___/___/___/___/___/___	[311]	PGM 11	___/___/___/___/___/___
[304]	PGM 4	___/___/___/___/___/___	[312]	PGM 12	___/___/___/___/___/___
[305]	PGM 5	___/___/___/___/___/___	[313]	PGM 13	___/___/___/___/___/___
[306]	PGM 6	___/___/___/___/___/___	[314]	PGM 14	___/___/___/___/___/___
[307]	PGM 7	___/___/___/___/___/___	[315]	PGM 15	___/___/___/___/___/___
[308]	PGM 8	___/___/___/___/___/___	[316]	PGM 16	___/___/___/___/___/___

NOTE: To view a PGM's serial number, see section [960] in *Description of Sections [950], [955], and [960]* on page 52.

Wireless PGM Signal Strength

The signal strength for wireless PGMs is visible in sections [321] to [336]; these sections represent PGMs 1 to 16, respectively. To view the signal strength, proceed as follows:

1. Enter the wireless PGM's respective section (e.g., for PGM1, enter section [321]).
2. Press the **LEARN/TAMPER** switch or remove and re-install Jumper 2 (JP2) on the wireless PGM. As shown in table 14, the number of beeps correspond to a preset signal strength range.

Table 14: Signal strength indicator for wireless PGMs

Number of Beeps	Signal Strength	Result
3	8 to 10	Strong signal
2	5 to 7	Average signal
1	1 to 4	Weak signal (relocate)

NOTE: The visual representation of a PGM's signal strength is dependent on the type of keypad. For LED keypads, zones 1 through 10 will illuminate, depending on the signal strength. For instance, a signal strength of 8 will result in zones 1 through 8 to illuminate. For LCD keypads, a ten-level progress bar composed of arrows will appear, followed by the numeric value. For a signal strength of 8, eight arrows will appear, followed by the number 8.

PGM Labels

Use worksheet 17 to record your settings for the SP+ PGM labels. To reset these labels, see *Description of Section [965]* on page 52.

Worksheet 17: PGM Labels

Section	PGM	PGM Label	Section	PGM	PGM Label
[341]	PGM 1	___/___/___/___/___/___/___/___/___/___/___/___	[349]	PGM 9	___/___/___/___/___/___/___/___/___/___/___/___
[342]	PGM 2	___/___/___/___/___/___/___/___/___/___/___/___	[350]	PGM 10	___/___/___/___/___/___/___/___/___/___/___/___
[343]	PGM 3	___/___/___/___/___/___/___/___/___/___/___/___	[351]	PGM 11	___/___/___/___/___/___/___/___/___/___/___/___
[344]	PGM 4	___/___/___/___/___/___/___/___/___/___/___/___	[352]	PGM 12	___/___/___/___/___/___/___/___/___/___/___/___
[345]	PGM 5	___/___/___/___/___/___/___/___/___/___/___/___	[353]	PGM 13	___/___/___/___/___/___/___/___/___/___/___/___
[346]	PGM 6	___/___/___/___/___/___/___/___/___/___/___/___	[354]	PGM 14	___/___/___/___/___/___/___/___/___/___/___/___
[347]	PGM 7	___/___/___/___/___/___/___/___/___/___/___/___	[355]	PGM 15	___/___/___/___/___/___/___/___/___/___/___/___
[348]	PGM 8	___/___/___/___/___/___/___/___/___/___/___/___	[356]	PGM 16	___/___/___/___/___/___/___/___/___/___/___/___

NOTE: For special characters and keypad letter assignments, see *Label Programming with LCD Keypads* on page 53.

User Programming

Use the following section to program the various user features on your SP+ Series control panel.

System Codes

Use worksheet 18 to record your settings for the SP+ system codes. For access options, see section [701], in table 24 on page 36.

NOTE: The maintenance code cannot access the following sections: [395] (Installer code lock); [397] (Installer code); [398] (Maintenance code); [815] (Monitoring station telephone number 1); [816] (Monitoring station telephone number 2); [817] (Backup monitoring station telephone); [910] (Panel ID); [911] (PC password); [970] (Download memory key into panel); [975] (Upload panel into the memory key).

Worksheet 18: User System Codes

Section	Data	Description	Default Setting
[395]	__/_/___	Installer code lock*	000
[397]	__/_/___/___/___/___	Installer code	0000
[398]	__/_/___/___/___/___	Maintenance code	-
[399]	__/_/___/___/___/___	System master code	1234

* Enter 147 to lock entire control panel. Once locked, enter any other three-digit combination to unlock.

NOTE: The installer and system master codes may consist of four (default) or six digits (see option 1 of section [701], in table 24 on page 36). The control panel automatically removes the last two digits of these codes, if the length is changed from six digits to four. However, if the access code length is changed from four digits to six, the control panel adds the code's first two digits to the end of the code.

User Code Options

Use worksheet 19 to record your settings for the SP+ Series user code options. See table 15 for details on these options.

Table 15: User code options

Option	Description
1	Partition 1 access
2	Partition 2 access
3	Bypass programming
4	Stay/Sleep arming
5	Force arming
6	Arm only
7	PGM activation only
8	Duress

NOTE: When section [400] is accessed, the control panel will copy the saved value of that section to all user option sections ([404] to [432]).

Worksheet 19: User Code Options

Section	User	Options	Section	User	Options
[400]	Default option	1 2 3 4 5 6 7 8	[417]	User 17	1 2 3 4 5 6 7 8
[401]	System master	1 2 3 4 5 6 7 8	[418]	User 18	1 2 3 4 5 6 7 8
[402]	Master 1	1 2 3 4 5 6 7 8	[419]	User 19	1 2 3 4 5 6 7 8
[403]	Master 2	1 2 3 4 5 6 7 8	[420]	User 20	1 2 3 4 5 6 7 8
[404]	User 4	1 2 3 4 5 6 7 8	[421]	User 21	1 2 3 4 5 6 7 8
[405]	User 5	1 2 3 4 5 6 7 8	[422]	User 22	1 2 3 4 5 6 7 8
[406]	User 6	1 2 3 4 5 6 7 8	[423]	User 23	1 2 3 4 5 6 7 8
[407]	User 7	1 2 3 4 5 6 7 8	[424]	User 24	1 2 3 4 5 6 7 8
[408]	User 8	1 2 3 4 5 6 7 8	[425]	User 25	1 2 3 4 5 6 7 8
[409]	User 9	1 2 3 4 5 6 7 8	[426]	User 26	1 2 3 4 5 6 7 8
[410]	User 10	1 2 3 4 5 6 7 8	[427]	User 27	1 2 3 4 5 6 7 8
[411]	User 11	1 2 3 4 5 6 7 8	[428]	User 28	1 2 3 4 5 6 7 8
[412]	User 12	1 2 3 4 5 6 7 8	[429]	User 29	1 2 3 4 5 6 7 8
[413]	User 13	1 2 3 4 5 6 7 8	[430]	User 30	1 2 3 4 5 6 7 8
[414]	User 14	1 2 3 4 5 6 7 8	[431]	User 31	1 2 3 4 5 6 7 8
[415]	User 15	1 2 3 4 5 6 7 8	[432]	User 32	1 2 3 4 5 6 7 8
[416]	User 16	1 2 3 4 5 6 7 8			

NOTE: The system master, master 1, and master 2 user code options cannot be modified. However, if partitioning is not enabled, the user code options for master 2 will match those of master 1.

Wireless Repeater Programming (RPT1/RPT1+)

Use the following section to program the wireless repeaters on your SP+ Series control panel.

Wireless Repeater Assignment

Use worksheet 22 to record your settings when assigning wireless repeaters to your SP+ Series control panel. To reset wireless repeaters, see *Description of Section [965]* on page 52.

Worksheet 22: Wireless Repeater Assignment

Section	Description	Wireless Repeater Serial Number
[545]	Repeater 1	___/___/___/___/___/___
[546]	Repeater 2	___/___/___/___/___/___

NOTE: For automatic assignment, press the wireless repeater's anti-tamper switch, while in the repeater's respective section.

Wireless Repeater Signal Strength

The signal strength for wireless repeaters is visible in sections [548] and [549]; these sections represent repeaters 1 and 2, respectively. To view the signal strength, proceed as follows:

1. Enter the wireless repeater's respective section (e.g., for repeater 1, enter section [548]).
2. Press the repeater's anti-tamper switch. As shown in table 16, the number of beeps correspond to a preset signal strength range.

Table 16: Signal strength indicator for wireless repeaters

Number of Beeps	Signal Strength	Result
3	8 to 10	Strong signal
2	5 to 7	Average signal
1	1 to 4	Weak signal (relocate)

NOTE: The visual representation of a repeater's signal strength is dependent on the type of keypad. For LED keypads, zones 1 through 10 will illuminate, depending on the signal strength. For instance, a signal strength of 8 will result in zones 1 through 8 to illuminate. For LCD keypads, a ten-level progress bar composed of arrows will appear, followed by the numeric value. For a signal strength of 8, eight arrows will appear, followed by the number 8.

Wireless Repeater Options

Table 17: Description of the wireless repeater options

Option	Description	RPT1/ RPT1+ [551]		RPT2 [561]	
		OFF	ON	OFF	ON
1	Repeat wireless keypad 1 signals	▲	□	▲	□
2	Repeat wireless keypad 2 signals	▲	□	▲	□
3	Repeat wireless keypad 3 signals	▲	□	▲	□
4	Repeat wireless keypad 4 signals	▲	□	▲	□
5	Repeat wireless keypad 5 signals	▲	□	▲	□
6	Repeat wireless keypad 6 signals	▲	□	▲	□
7	Repeat wireless keypad 7 signals	▲	□	▲	□
8	Repeat wireless keypad 8 signals	▲	□	▲	□

Option	Description	RPT1/ RPT1+ [552]		RPT2 [562]	
		OFF	ON	OFF	ON
1	Repeat wireless zone 1 signals	▲	□	▲	□
2	Repeat wireless zone 2 signals	▲	□	▲	□
3	Repeat wireless zone 3 signals	▲	□	▲	□
4	Repeat wireless zone 4 signals	▲	□	▲	□
5	Repeat wireless zone 5 signals	▲	□	▲	□
6	Repeat wireless zone 6 signals	▲	□	▲	□
7	Repeat wireless zone 7 signals	▲	□	▲	□
8	Repeat wireless zone 8 signals	▲	□	▲	□

Option	Description	RPT1/ RPT1+ [553]		RPT2 [563]	
		OFF	ON	OFF	ON
1	Repeat wireless zone 9 signals	▲	□	▲	□
2	Repeat wireless zone 10 signals	▲	□	▲	□
3	Repeat wireless zone 11 signals	▲	□	▲	□
4	Repeat wireless zone 12 signals	▲	□	▲	□
5	Repeat wireless zone 13 signals	▲	□	▲	□
6	Repeat wireless zone 14 signals	▲	□	▲	□
7	Repeat wireless zone 15 signals	▲	□	▲	□
8	Repeat wireless zone 16 signals	▲	□	▲	□

Option	Description	RPT1 / RPT1+ [554]		RPT2 [564]	
		OFF	ON	OFF	ON
1	Repeat wireless zone 17 signals	▲	□	▲	□
2	Repeat wireless zone 18 signals	▲	□	▲	□
3	Repeat wireless zone 19 signals	▲	□	▲	□
4	Repeat wireless zone 20 signals	▲	□	▲	□
5	Repeat wireless zone 21 signals	▲	□	▲	□
6	Repeat wireless zone 22 signals	▲	□	▲	□
7	Repeat wireless zone 23 signals	▲	□	▲	□
8	Repeat wireless zone 24 signals	▲	□	▲	□

Option	Description	RPT1 / RPT1+ [555]		RPT2 [565]	
		OFF	ON	OFF	ON
1	Repeat wireless zone 25 signals	▲	□	▲	□
2	Repeat wireless zone 26 signals	▲	□	▲	□
3	Repeat wireless zone 27 signals	▲	□	▲	□
4	Repeat wireless zone 28 signals	▲	□	▲	□
5	Repeat wireless zone 29 signals	▲	□	▲	□
6	Repeat wireless zone 30 signals	▲	□	▲	□
7	Repeat wireless zone 31 signals	▲	□	▲	□
8	Repeat wireless zone 32 signals	▲	□	▲	□

Option	Description	RPT1/ RPT1+ [556]		RPT2 [566]	
		OFF	ON	OFF	ON
1	Repeat wireless two-way PGM 1 signals	▲	□	▲	□
2	Repeat wireless two-way PGM 2 signals	▲	□	▲	□
3	Repeat wireless two-way PGM 3 signals	▲	□	▲	□
4	Repeat wireless two-way PGM 4 signals	▲	□	▲	□
5	Repeat wireless two-way PGM 5 signals	▲	□	▲	□
6	Repeat wireless two-way PGM 6 signals	▲	□	▲	□
7	Repeat wireless two-way PGM 7 signals	▲	□	▲	□
8	Repeat wireless two-way PGM 8 signals	▲	□	▲	□

Option	Description	RPT1 [557]		RPT2 [567]	
		OFF	ON	OFF	ON
1	Repeat wireless two-way PGM 9 signals	▲	□	▲	□
2	Repeat wireless two-way PGM 10 signals	▲	□	▲	□
3	Repeat wireless two-way PGM 11 signals	▲	□	▲	□
4	Repeat wireless two-way PGM 12 signals	▲	□	▲	□
5	Repeat wireless two-way PGM 13 signals	▲	□	▲	□
6	Repeat wireless two-way PGM 14 signals	▲	□	▲	□
7	Repeat wireless two-way PGM 15 signals	▲	□	▲	□
8	Repeat wireless two-way PGM 16 signals	▲	□	▲	□

▲ = Default Setting

Wireless Repeater Labels

Use worksheet 23 to record your settings for wireless repeater labels. To reset these labels, see *Description of Section [965]* on page 52.

Worksheet 23: Wireless Repeater Labels

Section	Description	Wireless Repeater Label
[568]	Repeater 1	___/___/___/___/___/___/___/___/___/___/___/___/___/___/___/___
[569]	Repeater 2	___/___/___/___/___/___/___/___/___/___/___/___/___/___/___/___

NOTE: For special characters and keypad letter assignments, see *Label Programming with LCD Keypads* on page 53.

Wireless Keypad Programming

Automatic Wireless Keypad Assignment

After powering-up, the control panel will open a ten-minute window for automatic assignment. To assign a keypad to your SP+ Series control panel, press and hold  and **BYP** for three seconds on the respective keypad. Up to eight wireless keypads can be assigned within this ten-minute period.

Compatibility Check (K37 only)

If the K37 is not compatible with the current SP+ Series control panel version, the following trouble will be displayed: **[TROUBLE: FLASH] [17: ON]**. If this occurs, update your SP+ Series control panel to version 3.2 or higher.

Standard Wireless Keypad Assignment

Use worksheet 24 to record your settings, when assigning wireless keypads to your SP+ Series control panel. To assign your wireless keypads, enter the serial number or press and hold  and **BYP** for three seconds.

Worksheet 24: Wireless Keypad Assignment

Section	Description	Wireless Keypad Serial Number
[571]	Keypad 1	___/___/___/___/___/___
[572]	Keypad 2	___/___/___/___/___/___
[573]	Keypad 3	___/___/___/___/___/___
[574]	Keypad 4	___/___/___/___/___/___
[575]	Keypad 5	___/___/___/___/___/___
[576]	Keypad 6	___/___/___/___/___/___
[577]	Keypad 7	___/___/___/___/___/___
[578]	Keypad 8	___/___/___/___/___/___

Wireless Keypad, Repeater, and Siren Options

Table 18: Description of section [587]

Option	Description	[587]		Option	Description	[587]	
		OFF	ON			OFF	ON
1	Repeater 1 supervision	<input type="checkbox"/>	▲	5	Wireless siren 3 supervision	<input type="checkbox"/>	▲
2	Repeater 2 supervision	<input type="checkbox"/>	▲	6	Wireless siren 4 supervision	<input type="checkbox"/>	▲
3	Wireless siren 1 supervision	<input type="checkbox"/>	▲	8	Live display mode	<input type="checkbox"/>	▲
4	Wireless siren 2 supervision	<input type="checkbox"/>	▲				

▲ = Default

NOTE: To cancel the wireless siren tamper supervision, see *Cancelling the Tamper Supervision for Wireless Sirens* on page 36.

Wireless Keypad Options

Table 19: Description of section [588]

Option	Description	[588]	
		OFF	ON
1	Keypad 1 supervision	<input type="checkbox"/>	<input checked="" type="checkbox"/>
2	Keypad 2 supervision	<input type="checkbox"/>	<input checked="" type="checkbox"/>
3	Keypad 3 supervision	<input type="checkbox"/>	<input checked="" type="checkbox"/>
4	Keypad 4 supervision	<input type="checkbox"/>	<input checked="" type="checkbox"/>

Option	Description	[588]	
		OFF	ON
5	Keypad 5 supervision	<input type="checkbox"/>	<input checked="" type="checkbox"/>
6	Keypad 6 supervision	<input type="checkbox"/>	<input checked="" type="checkbox"/>
7	Keypad 7 supervision	<input type="checkbox"/>	<input checked="" type="checkbox"/>
8	Keypad 8 supervision	<input type="checkbox"/>	<input checked="" type="checkbox"/>

▲= Default

Wireless Keypad Signal Strength

The signal strength for wireless keypads is visible in sections [591] to [598]; these sections represent keypads 1 through 8, respectively. To view the signal strength, proceed as follows:

1. Enter the wireless keypad's respective section (e.g., for keypad 1, enter section [591]).
2. Press  on the keypad. As shown in table 20, the number of beeps correspond to a preset signal strength range.

Table 20: Signal strength indicator for wireless keypads







Number of Beeps	Signal Strength	Result
3	8 to 10	Strong signal
2	5 to 7	Average signal
1	1 to 4	Weak signal (relocate)

NOTE: The visual representation of a keypad's signal strength is dependent on the type of keypad. For LED keypads, zones 1 through 10 will illuminate, depending on the signal strength. For instance, a signal strength of 8 will result in zones 1 through 8 to illuminate. For LCD keypads, a ten-level progress bar composed of arrows will appear, followed by the numeric value. For a signal strength of 8, eight arrows will appear, followed by the number 8.

Wireless Keypad Labels

Use worksheet 25 to record your settings for wireless keypad labels. To reset these labels, see *Description of Section [965]* on page 52.

Worksheet 25: Wireless Keypad Labels

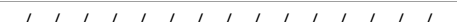
Section	Description	Wireless Keypad Label
[599]	Keypad 1	
[600]	Keypad 2	
[601]	Keypad 3	
[602]	Keypad 4	
[603]	Keypad 5	
[604]	Keypad 6	
[605]	Keypad 7	
[606]	Keypad 8	

NOTE: For special characters and keypad letter assignments, see *Label Programming with LCD Keypads* on page 53.

Remote Control Programming

Use the following section to program remote controls for your SP+ control panel.

Remote Control Button Assignment

Use worksheet 26 on page 34 to record your settings when assigning remote controls to your SP+ Series control panel. See table 21 for details on button options for these remotes.

NOTE: Remote controls which are supported by SP+ Series control panels are the following: REM1, REM2, RAC1, RAC2, REM3, and REM15.

Table 21: Button options for SP+ remote controls (see *Decimal and Hexadecimal Programming* on page 4)





Option	Description	Option	Description
Sleep	Empty/button disabled	8	Panic 1
1	Regular/regular force arming	9	Panic 2
2	Stay/stay force arming	A	Panic 3
3	-	B	PGM activation (event group 8)*
4	Sleep/sleep force arming	C	PGM activation (event group 9)*
5	PGM activation (event group 22)*	D	PGM activation (event group 10)*
6	PGM activation (event group 23)*	E	PGM activation (event group 11)*
7	Activate window mode (StayD)	F	Paramedic alarm

* For descriptions on the event groups, see *Description of Events* on page 18.

NOTE: The disarm button () cannot be modified.

Worksheet 26: Programming Remote Controls

		REM3 Remote Control							
		PGM 1 9	PGM 2 0	PGM 3 x	PGM 4 ✓	PGM 5 ●	PGM 6 ●	PGM 3 & 4 x+✓	PGM 5 & 6 ●+●
Default Data		B	C	D	E	5	6	Disabled	Disabled
RC #	Section								
All	[610]	_____	_____	_____	_____	_____	_____	_____	_____
1	[611]	_____	_____	_____	_____	_____	_____	_____	_____
2	[612]	_____	_____	_____	_____	_____	_____	_____	_____
3	[613]	_____	_____	_____	_____	_____	_____	_____	_____
4	[614]	_____	_____	_____	_____	_____	_____	_____	_____
5	[615]	_____	_____	_____	_____	_____	_____	_____	_____
6	[616]	_____	_____	_____	_____	_____	_____	_____	_____
7	[617]	_____	_____	_____	_____	_____	_____	_____	_____
8	[618]	_____	_____	_____	_____	_____	_____	_____	_____
9	[619]	_____	_____	_____	_____	_____	_____	_____	_____
10	[620]	_____	_____	_____	_____	_____	_____	_____	_____
11	[621]	_____	_____	_____	_____	_____	_____	_____	_____
12	[622]	_____	_____	_____	_____	_____	_____	_____	_____
13	[623]	_____	_____	_____	_____	_____	_____	_____	_____
14	[624]	_____	_____	_____	_____	_____	_____	_____	_____
15	[625]	_____	_____	_____	_____	_____	_____	_____	_____
16	[626]	_____	_____	_____	_____	_____	_____	_____	_____
17	[627]	_____	_____	_____	_____	_____	_____	_____	_____
18	[628]	_____	_____	_____	_____	_____	_____	_____	_____
19	[629]	_____	_____	_____	_____	_____	_____	_____	_____
20	[630]	_____	_____	_____	_____	_____	_____	_____	_____
21	[631]	_____	_____	_____	_____	_____	_____	_____	_____
22	[632]	_____	_____	_____	_____	_____	_____	_____	_____
23	[633]	_____	_____	_____	_____	_____	_____	_____	_____
24	[634]	_____	_____	_____	_____	_____	_____	_____	_____
25	[635]	_____	_____	_____	_____	_____	_____	_____	_____
26	[636]	_____	_____	_____	_____	_____	_____	_____	_____
27	[637]	_____	_____	_____	_____	_____	_____	_____	_____
28	[638]	_____	_____	_____	_____	_____	_____	_____	_____
29	[639]	_____	_____	_____	_____	_____	_____	_____	_____
30	[640]	_____	_____	_____	_____	_____	_____	_____	_____
31	[641]	_____	_____	_____	_____	_____	_____	_____	_____
32	[642]	_____	_____	_____	_____	_____	_____	_____	_____

		REM1/REM2/RAC1/RAC2/REM15			
					
Default Data		1	B	C	Disabled
RC #	Section				
All	[610]	_____	_____	_____	_____
1	[611]	_____	_____	_____	_____
2	[612]	_____	_____	_____	_____
3	[613]	_____	_____	_____	_____
4	[614]	_____	_____	_____	_____
5	[615]	_____	_____	_____	_____
6	[616]	_____	_____	_____	_____
7	[617]	_____	_____	_____	_____
8	[618]	_____	_____	_____	_____
9	[619]	_____	_____	_____	_____
10	[620]	_____	_____	_____	_____
11	[621]	_____	_____	_____	_____
12	[622]	_____	_____	_____	_____
13	[623]	_____	_____	_____	_____
14	[624]	_____	_____	_____	_____
15	[625]	_____	_____	_____	_____
16	[626]	_____	_____	_____	_____
17	[627]	_____	_____	_____	_____
18	[628]	_____	_____	_____	_____
19	[629]	_____	_____	_____	_____
20	[630]	_____	_____	_____	_____
21	[631]	_____	_____	_____	_____
22	[632]	_____	_____	_____	_____
23	[633]	_____	_____	_____	_____
24	[634]	_____	_____	_____	_____
25	[635]	_____	_____	_____	_____
26	[636]	_____	_____	_____	_____
27	[637]	_____	_____	_____	_____
28	[638]	_____	_____	_____	_____
29	[639]	_____	_____	_____	_____
30	[640]	_____	_____	_____	_____
31	[641]	_____	_____	_____	_____
32	[642]	_____	_____	_____	_____

NOTE: When section [610] is accessed, the control panel will copy the saved value of that section to all remote controls.

Important: When using an RTX3 with the SP+ Series, the left button on a remote control will, by default, trigger PGM3 on the RTX3.

User Assignment for Remote Controls

Table 22: User assignment per remote control

Section	Description	Section	Description	Section	Description	Section	Description
[651]	RC 1 for user 1	[659]	RC 9 for user 9	[667]	RC 17 for user 17	[675]	RC 25 for user 25
[652]	RC 2 for user 2	[660]	RC 10 for user 10	[668]	RC 18 for user 18	[676]	RC 26 for user 26
[653]	RC 3 for user 3	[661]	RC 11 for user 11	[669]	RC 19 for user 19	[677]	RC 27 for user 27
[654]	RC 4 for user 4	[662]	RC 12 for user 12	[670]	RC 20 for user 20	[678]	RC 28 for user 28
[655]	RC 5 for user 5	[663]	RC 13 for user 13	[671]	RC 21 for user 21	[679]	RC 29 for user 29
[656]	RC 6 for user 6	[664]	RC 14 for user 14	[672]	RC 22 for user 22	[680]	RC 30 for user 30
[657]	RC 7 for user 7	[665]	RC 15 for user 15	[673]	RC 23 for user 23	[681]	RC 31 for user 31
[658]	RC 8 for user 8	[666]	RC 16 for user 16	[674]	RC 24 for user 24	[682]	RC 32 for user 32

Assigning a Remote Control

1. Enter the remote's respective section (see table 22).
2. Press any button on the designated remote twice, or manually enter the serial number.

Deleting a Remote Control

1. Enter the remote's respective section (see table 22).
2. Enter **000000**.

NOTE: To view a remote control's serial number, see section [960] in *Description of Sections [950], [955], and [960]* on page 52.

Wireless Siren Programming

Use the following section to program wireless sirens for your SP+ control panel.

Wireless Siren Assignment

Use worksheet 27 to record your settings when assigning wireless sirens.

Worksheet 27: Wireless Siren Assignment

Section	Description	Wireless Siren Serial Number	Section	Description	Wireless Siren Serial Number
[683]	Siren 1	___/___/___/___/___	[685]	Siren 3	___/___/___/___/___
[684]	Siren 2	___/___/___/___/___	[686]	Siren 4	___/___/___/___/___

Wireless Siren Signal Strength

The signal strength for wireless keypads is visible in sections [687] to [690]; these sections represent sirens 1 through 4, respectively. To view the signal strength:

1. Enter the wireless siren's respective section (e.g., for siren 1, enter section [687]).
2. Note the number of beeps which are emitted. As shown in table 20, the number of beeps correspond to a preset signal strength range.

Table 23: Signal strength indicator for wireless sirens

Number of Beeps	Signal Strength	Result
3	8 to 10	Strong signal
2	5 to 7	Average signal
1	1 to 4	Weak signal (relocate)

NOTE: The visual representation of a siren's signal strength is dependent on the type of keypad. For LED keypads, zones 1 through 10 will illuminate, depending on the signal strength. For instance, a signal strength of 8 will result in zones 1 through 8 to illuminate. For LCD keypads, a ten-level progress bar composed of arrows will appear, followed by the numeric value. For a signal strength of 8, eight arrows will appear, followed by the number 8.

Wireless Siren Labels

Use worksheet 28 to record your settings for wireless siren labels. To reset these labels, see *Description of Section [965]* on page 52.

Worksheet 28: Wireless Siren Labels

Section	Description	Wireless Siren Label	Section	Description	Wireless Siren Label
[691]	Siren 1	___/___/___/___/___/___/___/___/___/___/___/___/___/___/___	[693]	Siren 3	___/___/___/___/___/___/___/___/___/___/___/___/___/___/___
[692]	Siren 2	___/___/___/___/___/___/___/___/___/___/___/___/___/___/___	[694]	Siren 4	___/___/___/___/___/___/___/___/___/___/___/___/___/___/___

NOTE: For special characters and keypad letter assignments, see *Label Programming with LCD Keypads* on page 53.

Canceling the Tamper Supervision for Wireless Sirens

To cancel tamper supervision, access section [695], and then press **ENTER**. The tamper supervision is disabled until the cover is replaced or after 30 minutes have elapsed.

Description of Sections [700] to [704]

The following section provides information on sections [700] to [704]. See table 24 for details. For keypad programming instructions, refer to  on page 7.

Table 24: Description of sections [700] to [704]

	Option	Option Type	Description	OFF		ON	
Section [700]	1	Partitioning	Partitioning	▲	Disabled	<input type="checkbox"/>	Enabled
	2	General system options	Future Use	-	-	-	-
	3		Audible trouble warning (except AC failure)	▲	Disabled	<input type="checkbox"/>	Enabled
	4		Audible trouble warning on AC failure	▲	Disabled	<input type="checkbox"/>	Enabled
	5		RF jamming supervision	RF jamming supervision	<input type="checkbox"/>	Disabled	▲
	6	General system options	Exit delay termination	▲	Disabled	<input type="checkbox"/>	Enabled
	7		Tamper supervision on the bus module	▲	Disabled	<input type="checkbox"/>	Enabled
	8	Future Use	-	-	-	-	-
Section [702]	1	Panic options	Panic 1	▲	Disabled	<input type="checkbox"/>	Enabled
	2		Panic 2	▲	Disabled	<input type="checkbox"/>	Enabled
	3		Panic 3	▲	Disabled	<input type="checkbox"/>	Enabled
	4		Panic 1: report only or audible alarm	▲	Report only	<input type="checkbox"/>	Audible
	5		Panic 2: report only or audible alarm	▲	Report only	<input type="checkbox"/>	Audible
	6		Panic 3: report only or audible alarm	▲	Report only	<input type="checkbox"/>	Audible
	7	Future use	-	-	-	-	
	8	Future use	-	-	-	-	
Section [704]	1	Arming/disarming options	Regular arming switches to force arming	<input type="checkbox"/>	Disabled	▲	Enabled
	2		Stay arming switches to stay force arming	<input type="checkbox"/>	Disabled	▲	Enabled
	3		Sleep arming switches to sleep force arming	<input type="checkbox"/>	Disabled	▲	Enabled
	4		Bell squawk when arm/disarm with remote	▲	Disabled	<input type="checkbox"/>	Enabled
	5	Keypad options 3	Bell squawk when arm/disarm with a keypad	▲	Disabled	<input type="checkbox"/>	Enabled
	6		Beep on exit delay	<input type="checkbox"/>	Disabled	▲	Enabled
	7		No exit delay beeps and no bell squawk, when stay/sleep arm	<input type="checkbox"/>	Disabled	▲	Enabled
	8		Arming/disarming options	No exit delay when arm with remote	▲	Disabled	<input type="checkbox"/>
Section [701]	1	Access/master code options	Access code length*	<input type="checkbox"/>	6 digits	▲	4 digits
	2		Lock master code	▲	Disabled	<input type="checkbox"/>	Enabled
	3	Keypad options 1**	Confidential mode	▲	Disabled	<input type="checkbox"/>	Enabled
	4		To exit confidential mode	▲	Enter code	<input type="checkbox"/>	Press a key
	5		Confidential mode timer	▲	2 mins.	<input type="checkbox"/>	5 secs.
	6	REM2 version number	REM2 version number	<input type="checkbox"/>	V2.00	▲	V2.01 or higher
	7	Keypad options 1	Display entry delay on LCD keypad	<input type="checkbox"/>	Disabled	▲	Enabled
	8		Display exit delay on LCD keypad	<input type="checkbox"/>	Disabled	▲	Enabled
Section [703]	1	Keypad options 2	One-touch regular arming (also REM3)	<input type="checkbox"/>	Disabled	▲	Enabled
	2		One-touch stay arming (also REM3)	<input type="checkbox"/>	Disabled	▲	Enabled
	3		One-touch sleep arming (also REM3)	<input type="checkbox"/>	Disabled	▲	Enabled
	4		One-touch bypass programming	<input type="checkbox"/>	Disabled	▲	Enabled
	5	Arming/disarming options	Restrict arming on battery failure	▲	Disabled	<input type="checkbox"/>	Enabled
	6		Restrict arming on tamper failure (zone + bus module + wireless PGM)	▲	Disabled	<input type="checkbox"/>	Enabled
	7		Restrict arming on supervision trouble; wireless zones & PGM + bus module	▲	Disabled	<input type="checkbox"/>	Enabled
	8	Future Use	-	-	-	-	

▲ = Default

*All numbers from 000000 to 999999 are valid giving a total of 1,000,000 different possible combinations.

**Automatic timed operation that will make indications inaccessible to users without a valid access code.

Zone Options

Use the following section to program zone options for your SP+ Series control panel.

ATZ, Zone Tamper, and Supervision Options

Table 25: Description of section [705]

Option	Description	OFF		ON		
		Symbol	Value	Symbol	Value	
Section [705]	1	ATZ zone doubling	▲	Disabled	<input type="checkbox"/> Enabled	
	2	ATZ wiring options	▲	Series	<input type="checkbox"/> Parallel	
	3	Tamper recognition	(see table 26 for details)			
	4					
	5	Generate tamper on bypassed zone	<input type="checkbox"/>	No	▲	Yes
	6	Supervision options	(see table 26 for details)			
	7					
	8	Generate supervision on bypassed zone	<input type="checkbox"/>	No	▲	Yes

▲ = Default

NOTE: ATZ is only available for the SP6000+.

Table 26: Description of options 3 & 4 and 6 & 7, in section [705]

Option		Description	
3	4	RF Zone/Hardwired Zone Tamper Recognition Options	Keypad/Bus Module Tamper Recognition Options*
OFF	OFF	Disabled	Disabled
OFF	ON	Trouble only	Trouble only
ON	OFF	When disarmed: trouble only; when armed: follow zone's alarm type	Trouble only
ON	ON	When disarmed: audible alarm; when armed: follow zone's alarm type	Audible alarm
6	7	RF Zone Supervision Options	Keypad/Bus Module Supervision Options
OFF	OFF	Disabled	Disabled
OFF	ON	Trouble only	Trouble only
ON	OFF	When disarmed: trouble only; when armed: follow zone's alarm type	Trouble only
ON	ON	When disarmed: audible alarm; when armed: follow zone's alarm type	Audible alarm

* Tamper recognition of keypad/bus module, only if section [700], option 7, is enabled.

General Zone Options

Table 27: Description of section [706]

Option	Description	OFF		ON	
		Symbol	Value	Symbol	Value
Section [706]	1	Check-in supervision time	▲	24 hours	<input type="checkbox"/> 80 minutes
	2	EOL resistors (applies to all hardwired zones – panel, keypad, ZX8/ZX82)	▲	Disabled	<input type="checkbox"/> Enabled
	3	Zone input 1 becomes a two-wire smoke input	▲	Disabled	<input type="checkbox"/> Enabled
	4	ZX8/ZX82 ID A (panel + 1) input 1	▲	Zone input	<input type="checkbox"/> Tamper input
	5	ZX8/ZX82 ID B (panel + 9) input 1	▲	Zone input	<input type="checkbox"/> Tamper input
	6	ZX8/ZX82 ID C (panel + 17) input 1	▲	Zone input	<input type="checkbox"/> Tamper input

▲ = Default

Miscellaneous System Options

Table 28: Description of section [708]

	Option	Description	OFF		ON	
Section [708] ENS0131 OPTIONS	1	Enter code to view trouble	▲	One-touch	<input type="checkbox"/>	Enter code
	2	Enter code to view alarm in memory/event list	▲	One-touch	<input type="checkbox"/>	Enter code
	3	Trouble latch	▲	Disabled	<input type="checkbox"/>	Enabled
	4	Bell squawk on Installer in	▲	Disabled	<input type="checkbox"/>	Enabled
	5	Acknowledge trouble(s) before arming	▲	Disabled	<input type="checkbox"/>	Enabled
	6	Do not arm if zone opens during exit delay	▲	Disabled	<input type="checkbox"/>	Enabled
	7	Disable 'Bypass and Arm'	▲	Disabled	<input type="checkbox"/>	Enabled
	8	Future use				

▲ = Default

Unlock Panel Serial Ports

Enter section [300] to unlock your SP+'s panel serial ports for use with third-party devices using a TM70/TM50 Touch keypad and the K32LCD+. For a step-by-step procedure, refer to the Insite Gold Installer Menu Guide.

System Timers

Use the following section to program system timers on your SP+ Series control panel. Use worksheet 29 to record your settings.

Worksheet 29: System Timers

Section	Data	Description	Section	Data	Description
[710]	__/__/__ 000 to 255 seconds	Entry delay 1* (default: 045)	[718]	__/__/__ 000 to 255 seconds	Remote panic disarm lock delay (default: 000)
[711]	__/__/__ 000 to 255 seconds	Entry delay 2* (default: 045)	[719]	__/__/__ 000 to 255 days	Closing delinquency delay (default: 000)
[712]	__/__/__ 000 to 015	Auto-zone shutdown counter (default: 005)	[720]	__/__/__ 000 to 255 seconds	Flex-instant delay (default: 015)
[713]	__/__/__ 000 to 255 seconds	Intellizone delay (default: 048)	[721]	__/__/__ 000 to 255 seconds	For StayD: re-arm delay (default: 005)
[714]	__/__/__ 000 to 255 minutes	Recycle alarm delay (default: 000)	[722]	__/__/__ 000 to 255 times	Auto trouble shutdown** (default: 000)
[715]	__/__/__ 000 to 255	Recycle alarm counter (default: 000)	[723]	__/__/__ 000 to 255 seconds	Panic shutdown** (default: 000)

* For EN 50131, the maximum value is 45 seconds.

** For EN 50131, the section must be set to a minimum of 3 and a maximum of 10

Keypad Lockout

Use the following section to program keypad lockout settings for your SP+ Series control panel. Use worksheet 30 to record your settings.

Worksheet 30: Keypad Lockout

Section	Data	Description	Default
[716]	__/__/__ 000 to 255 minutes	Keypad lockout delay	000
[717]	__/__/__ 000 to 255 attempts before locking	Keypad lockout counter	000

NOTE: For EN 50131, the keypad lockout value must be set between three and ten attempts. The minimum delay to lock must be two minutes.

Programming the Daylight Savings Feature

Use the following section to program Daylight Savings Time on your SP+ Series control panel. Use worksheet 31 to record your settings.

Table 29: Description of section [730]

Section	Option	Description	OFF		ON	
[730]	1	Daylight savings	▲	Disabled	<input type="checkbox"/>	Enabled

▲ = Default

Country Codes

Table 30 lists countries and their respective codes. This information is required when programming section [731] (see worksheet 31 for details).

Table 30: Country codes for SP+ control panels

Input Value	Country	Input Value	Country
00	Mexico; St. Johns; Bahamas; Turks and Caicos	10	Chatham
01	Cuba	11	Tonga
02	Brazil	12	Iraq; Syria
03	Chile	13	Israel
04	Falkland Islands	14	Lebanon; Kyrgyzstan
05	Paraguay	15	Palestine
06	European Union; United Kingdom; Greenland	16	Egypt
07	Russia and surrounding countries	17	Namibia
08	South Australia; Victoria; Australian Capital Territory; New South Wales	18	Canada; United States
09	Tasmania; Lord Howe Island	19	New Zealand

Customized Daylight Savings Features

In addition to using the default Daylight Saving Time (DST) settings in section [731], you can also set a customized DST. In sections [732] and [733], you can program DST starting and ending periods, respectively. Both these sections recognize five different entries, consisting of two digits each.

All entries must be made in the following order:

1. **Month:** 01 to 12, where 01 represents January
2. **Date:** 01 to 31, where 01 represents the first day of the month
3. **Day:** 00 to 07, where 00 is the default setting and 01 represents Sunday
4. **Hours:** 00 to 23, where 00 represents 12:00 AM
5. **Minutes:** 00 only, where 00 represents the top of the hour (e.g., 12:00 AM)

NOTE: If the Day value is set to 00, it is ignored and the DST change will only respect the Date value. If the Day setting is set to a value other than 00 (e.g., 03 for Tuesday), the DST time change will occur on the first Tuesday following the programmed Date value.

Worksheet 31: Daylight Savings Time

Section	Data	Description
[731]	__/_	00 to 99 Country code
[732]	__/__/__/__/__/__/__/__/	Month-date-day-hours-minutes DST starting period
[733]	__/__/__/__/__/__/__/__/	Month-date-day-hours-minutes DST ending period

NOTE: If sections [732] and [733] have been modified, but you want to revert to a standard DST code, change all settings in sections [732] and [733] to 00.

Partition Programming

Use the following section to program partitions on your SP+ Series control panel.

Partition Options

Table 31: Description of partition 1 options (section [741])

Option	Description	OFF		ON	
		OFF	ON	OFF	ON
1	Auto-arm on time	▲	Disabled	□	Enabled
2	Auto-arm on no movement	▲	Disabled	□	Enabled
3 & 4	Auto-arm arming mode	□	See options 3 & 4, on right	□	See options 3 & 4, on right
5	Switch to stay arming, if no entry zone is opened	▲	Disabled	□	Enabled
6	Follow zones become entry delay 2, when delay zone is bypassed	▲	Disabled	□	Enabled

Option	Description
3 4	Regular (default)
OFF OFF	Sleep
ON OFF	Stay

▲ = Default

Table 32: Description of partition 2 options (section [742])

Option	Description	OFF		ON	
		Symbol	Status	Symbol	Status
1	Auto-arm on time	▲	Disabled	<input type="checkbox"/>	Enabled
2	Auto-arm on no movement	▲	Disabled	<input type="checkbox"/>	Enabled
3 & 4	Auto-arm arming mode	<input type="checkbox"/>	See options 3 & 4, on right	<input type="checkbox"/>	See options 3 & 4, on right
5	Switch to stay arming, if no entry zone is opened	▲	Disabled	<input type="checkbox"/>	Enabled
6	Follow zones become entry delay 2, when delay zone is bypassed	▲	Disabled	<input type="checkbox"/>	Enabled

Option	Description
3 4	
OFF OFF	Regular (default)
OFF ON	Sleep
ON OFF	Stay

▲= Default

Partition Timers

Use worksheet 32 to record your settings for partition timers.

Worksheet 32: Partition Timers

Section	Data	Description	Default
[745]	___/___/___ 000 to 255 seconds	Partition 1 exit delay	060
[746]	___/___/___ 000 to 255 seconds	Partition 2 exit delay	060
[747]	___/___/___ 000 to 255 minutes	Partition 1 bell cut-off	004*
[748]	___/___/___ 000 to 255 minutes	Partition 2 bell cut-off	004*
[749]	___/___/___ 000 to 255 x 15 minutes	Partition 1 no movement	000
[750]	___/___/___ 000 to 255 x 15 minutes	Partition 2 no movement	000
[761]	___/___ : ___/___ HH:MM	Auto-arm on time partition 1	00:00
[762]	___/___ : ___/___ HH:MM	Auto-arm on time partition 2	00:00

*For EN 50131, the minimum bell cut-off timer value should be 2 minutes and maximum 60 minutes.

Partition Labels

Use worksheet 33 to record your settings for partition labels. To reset these labels, see *Description of Section [965]* on page 52.

Worksheet 33: Partition Labels

Section	Description	Partition Label
[771]	Partition 1	___/___/___/___/___/___/___/___/___/___/___/___/___/___/___/___
[772]	Partition 2	___/___/___/___/___/___/___/___/___/___/___/___/___/___/___/___

NOTE: For special characters and keypad letter assignments, see *Label Programming with LCD Keypads* on page 53.

SMS and Bus Module Programming

Use the following section to program SMS site name and bus module labels on your SP+ Series control panel.

SMS Site Name

Use worksheet 34 to record your SMS site name. See worksheet 50 on page 51, for additional communication settings.

Worksheet 34: SMS Site Name

Section	Description	Name
[780]	SMS site name	___/___/___/___/___/___/___/___/___/___/___/___/___/___/___/___

Bus Module Labels

Use worksheet 35 to record your settings for bus module labels. To reset these labels, see *Description of Section [965]* on page 52.

Worksheet 35: Bus Module Labels

Section	Description	Bus Module Label
[781]	Bus 1	___/___/___/___/___/___/___/___/___/___/___/___/___/___/___/___
[782]	Bus 2	___/___/___/___/___/___/___/___/___/___/___/___/___/___/___/___
[783]	Bus 3	___/___/___/___/___/___/___/___/___/___/___/___/___/___/___/___
[784]	Bus 4	___/___/___/___/___/___/___/___/___/___/___/___/___/___/___/___
[785]	Bus 5	___/___/___/___/___/___/___/___/___/___/___/___/___/___/___/___
[786]	Bus 6	___/___/___/___/___/___/___/___/___/___/___/___/___/___/___/___
[787]	Bus 7	___/___/___/___/___/___/___/___/___/___/___/___/___/___/___/___
[788]	Bus 8	___/___/___/___/___/___/___/___/___/___/___/___/___/___/___/___
[789]	Bus 9	___/___/___/___/___/___/___/___/___/___/___/___/___/___/___/___
[790]	Bus 10	___/___/___/___/___/___/___/___/___/___/___/___/___/___/___/___
[791]	Bus 11	___/___/___/___/___/___/___/___/___/___/___/___/___/___/___/___
[792]	Bus 12	___/___/___/___/___/___/___/___/___/___/___/___/___/___/___/___
[793]	Bus 13	___/___/___/___/___/___/___/___/___/___/___/___/___/___/___/___
[794]	Bus 14	___/___/___/___/___/___/___/___/___/___/___/___/___/___/___/___
[795]	Bus 15	___/___/___/___/___/___/___/___/___/___/___/___/___/___/___/___

NOTE: For special characters and keypad letter assignments, see *Label Programming with LCD Keypads* on page 53.

Communication Programming

Use the following section to program various communication features on your SP+ Series control panel. Table 33 lists features available for each SP+ Series control panel.

Prioritization of signals and messages are based on a “first in, first out” scheme. Systems meet EN 50136 ATS2 or ATS3 requirements when configured as depicted.

NOTE: For increased security, it is suggested that redundant communication methods be installed.

Table 33: Communication features for SP+ Series panels

Communication Feature	Control Panel		
	SP5500+	SP6000+	SP7000+
GPRS reporting (PCS series)	✓	✓	✓
SMS (PCS series)	✓	✓	✓
IP reporting (IP Module)	✓	✓	✓
E-mail/monitoring (IP Module)	✓	✓	✓
Patented dialer	✓	✓	✓

Dialer Options

Table 34: Description of dialer options for landline communication (section [800])

Option	Description	OFF		ON	
		1	2	1	2
1 & 2	Telephone line monitoring	<input type="checkbox"/>	See options 1 & 2, on right	<input type="checkbox"/>	See options 1 & 2, on right
3	Switch to pulse on fifth attempt	▲	Disabled	<input type="checkbox"/>	Enabled
4	Alternate dial	▲	Disabled	<input type="checkbox"/>	Enabled
5	Force dial (must be enabled to comply with TBR-21)	<input type="checkbox"/>	Disabled	▲	Enabled
6	DTMF dialing	<input type="checkbox"/>	Disabled	▲	Enabled
7	Pulse ratio	<input type="checkbox"/>	1:2	▲	1:1.5
8	Reporting*	▲	Dialer activated	<input type="checkbox"/>	No dialer

Option		Description
1	2	
OFF	OFF	Disabled (default)
OFF	ON	Trouble only
ON	OFF	When disarmed: trouble only; when armed: audible only
ON	ON	Silent alarms become audible alarm

▲ = Default

* This option also applies to landline.

Table 35: Description of general communication dialer options (section [801])

Option	Description	OFF		ON	
		1	2	1	2
1	Report system disarming	<input type="checkbox"/>	Always	▲	After alarm
2	Report zone restore	▲	Bell cutoff	<input type="checkbox"/>	Zone closure
3 & 4	Auto-test report transmission	<input type="checkbox"/>	See table 36 on page 41	<input type="checkbox"/>	See table 36 on page 41
5	Contact ID override	▲	Disabled	<input type="checkbox"/>	CID defaults/slow format custom
6	Future Use	-	-	-	-
7	Future Use	-	-	-	-
8	Future Use	-	-	-	-

▲ = Default

Table 36: Auto-test report transmission options (section [801])

Option	Option		Description
	3	4	
1	OFF	OFF	Transmit the test report code when the days programmed in section [840] have elapsed, at the time programmed in section [850] (default).
2	OFF	ON	When disarmed: transmit test report code when the time programmed in section [852] has elapsed. When armed: transmit test report code when the time programmed in section [851] has elapsed.
3	ON	OFF	The control panel will transmit the test report code every hour, on the minute value programmed in section [850] (the last two digits); the first two digits of section [850] will be ignored. For example, if 10:25 was programmed into section [850], the test report code would be transmitted at the 25th minute of every hour, i.e., 11:25, 12:25, etc.
4	ON	ON	The test report code will be transmitted when the conditions in entries 2 or 3 above (option 3 = OFF and option 4 = ON; option 3 = ON and option 4 = OFF), are met.

Event Call Direction Options

Table 37: Description of event call direction options (sections [802] to [804])

	Option	Description	OFF		ON	
			<input type="checkbox"/>	Disabled	<input checked="" type="checkbox"/>	Enabled
Section [802] Event Call Direction Options 1	1	Call tel. #1/monitoring rcvr. #1 for arm/disarm report codes	<input type="checkbox"/>	Disabled	<input checked="" type="checkbox"/>	Enabled
	2	Call tel. #2/monitoring rcvr. #2 for arm/disarm report codes	<input type="checkbox"/>	Disabled	<input checked="" type="checkbox"/>	Enabled
	3	N/A				
	5	Call tel. #1/monitoring rcvr. #1 for alarm/restore report codes	<input type="checkbox"/>	Disabled	<input checked="" type="checkbox"/>	Enabled
	6	Call tel. #2/monitoring rcvr. #2 for alarm/restore report codes	<input type="checkbox"/>	Disabled	<input checked="" type="checkbox"/>	Enabled
	7	N/A				
	Section [804] Event Call Direction Options 3	1	Call tel. #1/monitoring rcvr. #1 for special report codes	<input type="checkbox"/>	Disabled	<input checked="" type="checkbox"/>
2		Call tel. #2/monitoring rcvr. #2 for special report codes	<input type="checkbox"/>	Disabled	<input checked="" type="checkbox"/>	Enabled
3		N/A				
5		Call personal tel. # on zone alarm (burglary/fire)	<input type="checkbox"/>	Disabled	<input checked="" type="checkbox"/>	Enabled
6		Call personal tel. # on panic alarms	<input type="checkbox"/>	Disabled	<input checked="" type="checkbox"/>	Enabled
7		Call personal tel. # on paramedic alarms	<input type="checkbox"/>	Disabled	<input checked="" type="checkbox"/>	Enabled
8		Call personal tel. # on panel power trouble	<input checked="" type="checkbox"/>	Disabled	<input type="checkbox"/>	Enabled

	Option	Description	OFF		ON	
			<input type="checkbox"/>	Disabled	<input checked="" type="checkbox"/>	Enabled
Section [803] Event Call Direction Options 2	1	Call tel. #1/monitoring rcvr. #1 for tamper/restore report codes	<input type="checkbox"/>	Disabled	<input checked="" type="checkbox"/>	Enabled
	2	Call tel. #2/monitoring rcvr. #2 for tamper/restore report codes	<input type="checkbox"/>	Disabled	<input checked="" type="checkbox"/>	Enabled
	3	N/A				
	5	Call tel. #1/monitoring rcvr. #1 for trouble/restore report codes	<input type="checkbox"/>	Disabled	<input checked="" type="checkbox"/>	Enabled
	6	Call tel. #2/monitoring rcvr. #2 for trouble/restore report codes	<input type="checkbox"/>	Disabled	<input checked="" type="checkbox"/>	Enabled
	7	N/A				

▲ = Default

IP/GPRS Options

Table 38: Description of IP/GPRS options (section [806])

	Option	Description	OFF		ON	
			<input checked="" type="checkbox"/>	See options 5 & 6	<input type="checkbox"/>	See options 5 & 6
Section [806]	5 & 6	IP no service trouble feedback	<input checked="" type="checkbox"/>	See options 5 & 6	<input type="checkbox"/>	See options 5 & 6
	7	User dialer reporting	<input checked="" type="checkbox"/>	As backup for IP/GPRS reporting	<input type="checkbox"/>	Enabled In addition to IP reporting
	8	Enable IP/GPRS reporting	<input type="checkbox"/>	Disabled	<input checked="" type="checkbox"/>	Enabled
▲ = Default						

Option		Description
5	6	
OFF	OFF	Disabled
OFF	ON	Trouble only
ON	OFF	When disarmed: trouble only; when armed: audible alarm
ON	ON	Silent alarm becomes audible alarm

Test Report and Report Delays

Use worksheet 39 to record your settings for sections [850] to [852]. For additional timers, see worksheets 38 and 47 on pages 43 and 50, respectively.

Worksheet 39: Test Report and Report Delays

Section	Data	Description	Default
[850]	__/__/__	HH:MM Auto test report time of day (see table 36 on page 41)	00:00
[851]	__/__/__	000 to 255 minutes Armed report delay	005
[852]	__/__/__	000 to 255 minutes Disarmed report delay	060

System and Communication Report Codes

Use the following section to program system report codes, as well as additional communication report codes on your SP+ control panel.

Entering Report Codes

- **For Ademco slow, Silent Knight, SESCOA, and Ademco express formats**, key-in the desired two-digit hex value from 00 to FF.
- **For Ademco Programmable Format**, enter the desired two-digit hex value, found in table 41 on page 46. Entering FF will set the report code to those outlined in table 42 on page 48.
- **For Ademco All Codes Format**, the control panel automatically generates report codes from the ones found in table 42 on page 48.

Special Arming and Disarming Report Codes

Use worksheet 40 to record your settings for special arming and disarming report codes.

Worksheet 40: Special Arming and Disarming Report Codes

Section	Data	Description
[860]	__/__	Auto-arming
	__/__	Late to close
	__/__	No movement
	__/__	Partial arming

Default: FF

Section	Data	Description
[861]	__/__	Quick arming
	__/__	Arming via PC
	__/__	Arming with keyswitch
	__/__	-

Section	Data	Description
[862]	__/__	Cancel auto-arm
	__/__	Disarming via PC
	__/__	Cancel alarm with user or BabyWare
	__/__	Cancel paramedic

Special Alarm Report Codes

Use worksheet 41 to record your settings for special alarm report codes.

Worksheet 41: Special Alarm Report Codes

Section	Data	Description
[863]	__/__	Emergency panic
	__/__	Auxiliary panic
	__/__	Fire panic
	__/__	Recent closing

Default: FF

Section	Data	Description
[864]	__/__	Zone shutdown
	__/__	Duress
	__/__	Keypad lockout
	__/__	Paramedic alarm

System Trouble Report Codes

Use worksheet 42 to record your settings for system trouble report codes.

Worksheet 42: Special Trouble Report Codes

Section	Data	Description
	___/___	-
[865]	___/___	AC failure
	___/___	Battery failure
	___/___	Auxiliary supply
	___/___	Module power fail
[868]	___/___	Module low/no battery*
	___/___	Wireless zone low battery
	___/___	Wireless zone supervision lost

Section	Data	Description
	___/___	Bell output overload
[866]	___/___	Bell output disconnected
	___/___	Timer loss
	___/___	Fire loop trouble
	___/___	Wireless module supervision lost
[869]	___/___	Wireless module tamper
	___/___	Remote low battery
	___/___	-

Section	Data	Description
	___/___	Fail to communicate
[867]	___/___	RF jamming
	___/___	Module lost
	___/___	Module tamper

Default: FF

System Trouble Restore Codes

Use worksheet 43 to record your settings for system trouble restore codes.

Worksheet 43: System Trouble Restore Codes

Section	Data	Description
	___/___	TLM
[870]	___/___	AC failure
	___/___	Battery failure
	___/___	Auxiliary supply
	___/___	Module power fail
[873]	___/___	Module low/no battery*
	___/___	Wireless zone low battery
	___/___	Wireless zone supervision lost

Section	Data	Description
	___/___	Bell output overload
[871]	___/___	Bell output disconnect
	___/___	Timer loss
	___/___	Fire loop trouble
	___/___	Wireless module supervision lost*
[874]	___/___	Wireless module tamper
	___/___	Remote low battery
	___/___	-

Section	Data	Description
	___/___	Fail to communicate
[872]	___/___	RF jamming
	___/___	Module lost
	___/___	Module tamper

Default: FF

System Special Report Codes

Use worksheet 44 to record your settings for system special report codes.

Worksheet 44: System Special Report Codes

Section	Data	Description
	___/___	Cold start
[875]	___/___	Test report
	___/___	-
	___/___	Software out

Default: FF

Section	Data	Description
	___/___	Installer in
[876]	___/___	Installer out
	___/___	Closing delinquency
	___/___	-

Section	Data	Description
	___/___	-
[877]	___/___	-
	___/___	-
	___/___	Fail to arm

NOTE: For report code formatting instructions, see *Entering Report Codes* on page 44.

Installer Function Keys

Table 40: Description of installer functions for SP+ keypads

Function	Action	Description
Test report	ENTER + installer code + ENTER	Sends the <i>Test Report</i> report code programmed in section [875], to the monitoring station.
Cancel communication	ENTER + installer code + STAY	Cancels all communication with the BabyWare software or with the monitoring station, until the next reportable event.
Answer BabyWare software	ENTER + installer code + SLEEP	Will force the console to answer an incoming call from the monitoring station, which is using the BabyWare software.
Call BabyWare software	ENTER + installer code + BYP	Will dial the PC telephone number programmed in section [915], thereby initiating communication with a computer using the BabyWare software.
Installer test mode	ENTER + installer code + TBL	This mode allows to perform walk tests, where the siren will squawk to indicate opened zones. To exit, press TBL .

Contact ID Report Codes

Table 41: Ademco contact ID report codes

Type	CID #	Reporting Code	Value
Medical Alarms (100)	100	Medical alarm	01
	101	Pendant transmitter	02
	102	Fail to report in	03
Fire Alarms (110)	110	Fire Alarm	04
	111	Smoke	05
	112	Combustion	06
	113	Water Flow	07
	114	Heat	08
	115	Pull Station	09
	116	Duct	0A
	117	Flame	0B
	118	Near Alarm	0C
	Panic Alarms (120)	120	Panic alarm
121		Duress	0E
122		Silent	0F
123		Audible	10
124		Duress - access granted	11
125		Duress - egress granted	12
Burglar Alarms (130)	130	Burglary	13
	131	Perimeter	14
	132	Interior	15
	133	24-hour	16
	134	Entry/exit	17
	135	Day/night	18
	136	Outdoor	19
	137	Tamper	1A
	138	Near alarm	1B
	139	Intrusion verifier	1C
General Alarms (140)	140	General alarm	1D
	141	Polling loop open	1E
	142	Polling loop short	1F
	143	Extension module failure	20
	144	Sensor tamper	21
	145	Expansion module tamper	22
	146	Silent burglary	23
	147	Sensor supervision failure	24

Table 41: Ademco contact ID report codes (Continued)

Type	CID #	Reporting Code	Value	
24-hour Non-burglary (150 & 160)	150	24-hour non-burglary	25	
	151	Gas detected	26	
	152	Refrigeration	27	
	153	Loss of heat	28	
	154	Water leakage	29	
	155	Foil break	2A	
	156	Day trouble	2B	
	157	Low bottled gas level	2C	
	158	High temperature	2D	
	159	Low temperature	2E	
	161	Loss of air flow	2F	
	162	Carbon monoxide detected	30	
	163	Tank level	31	
	Fire Supervisory (200 & 210)	200	Fire supervisory	32
201		Low water pressure	33	
202		Low CO2	34	
203		Gate valve sensor	35	
204		Low water level	36	
205		Pump activated	37	
206		Pump failure	38	
300		System trouble	39	
System Troubles (300 & 310)	301	AC loss	3A	
	302	Low system battery	3B	
	303	RAM checksum bad	3C	
	304	ROM checksum	3D	
	305	System reset	3E	
	306	Panel program changed	3F	
	307	Self-test failure	40	
	308	System shutdown	41	
	309	Battery test failure	42	
	310	Ground fault	43	
	311	Battery missing/dead	44	
	312	Powr. supply over current limit	45	
	313	Engineer reset	46	
	Sounder/Relay Troubles (320)	320	Sounder relay	47
		321	Bell 1	48
		322	Bell 2	49
		323	Alarm relay	4A
324		Trouble relay	4B	
325		Reversing relay	4C	
326		Notification appliance chk. #3	4D	
327		Notification appliance chk. #4	4E	

Table 41: Ademco contact ID report codes (Continued)

Type	CID #	Reporting Code	Value	
System Peripheral Troubles (330 & 340)	330	System peripheral	4F	
	331	Polling loop open	50	
	332	Polling loop short	51	
	333	Expansion module failure	52	
	334	Repeater failure	53	
	335	Local printer paper out	54	
	336	Local printer failure	55	
	337	Exp. module DC loss	56	
	338	Exp. module low battery	57	
	339	Exp. module reset	58	
	341	Exp. module tamper	59	
	342	Exp. module AC loss	5A	
	343	Exp. module self-test fail	5B	
	344	RF receiver jam detected	5C	
Communication Troubles (350 & 360)	350	Communication	5D	
	351	Telco fault 1	5E	
	352	Telco fault 2	5F	
	353	Long range radio	60	
	354	Fail to communicate	61	
	355	Loss of radio supervision	62	
	356	Loss of central polling	63	
	357	Long range radio VSWR problem	64	
	Protection Loop Troubles (370)	370	Protection loop	65
		371	Protection loop open	66
372		Protection loop short	67	
373		Fire trouble	68	
374		Exit error alarm	69	
375		Panic zone trouble	6A	
376		Hold-up zone trouble	6B	
377		Swinger trouble	6C	
378		Cross-zone trouble	6D	
Sensor Troubles (380 & 390)		380	Sensor trouble	6E
	381	Loss of supervision - RF	6F	
	382	Loss of supervision - RPM	70	
	383	Sensor tamper	71	
	384	RF transmitter low battery	72	
	385	Smoke detector hi sensitivity	73	
	386	Smoke detector low sensitivity	74	
	387	Intrusion detector hi sensitivity	75	
	388	Intrusion detector low sensitivity	76	
	389	Sensor self-test failure	77	
	391	Sensor watch trouble	78	
	392	Drift compensation error	79	
	393	Maintenance alert	7A	

Table 41: Ademco contact ID report codes (Continued)

Type	CID #	Reporting Code	Value
Open/Close (400)	400	Open/close	7B
	401	Open/close by user	7C
	402	Group open/close	7D
	403	Automatic open/close	7E
	406	Cancel	7F
	407	Remote arm/disarm	80
	408	Quick arm	81
	409	Keyswitch open/close	82
	411	Call back request made	83
Remote Access (410)	412	Successful - download access	84
	413	Unsuccessful access	85
	414	System shutdown	86
	415	Dialer shutdown	87
	416	Successful upload	88
Access Control (420 & 430)	421	Access denied	89
	422	Access report by user	8A
	423	Forced access	8B
	424	Egress denied	8C
	425	Egress granted	8D
	426	Access door propped open	8E
	427	Access point door status monitor trouble	8F
	428	Access point request to exit	90
	429	Access program mode entry	91
	430	Access program mode exit	92
	431	Access threat level change	93
	432	Access relay/trigger fail	94
	433	Access RTE shunt	95
	434	Access DSM shunt	96
Arming (440 & 450)	441	Armed stay	97
	442	Keyswitch armed stay	98
	450	Exception open/close	99
	451	Early open/close	9A
	452	Late open/close	9B
	453	Failed to open	9C
	454	Failed to close	9D
	455	Auto-arm failed	9E
	456	Partial arm	9F
	457	User exit error	A0
System (460)	458	User on premises	A1
	459	Recent close	A2
	461	Wrong code entry	A3
	462	Legal code entry	A4
	463	Re-arm after alarm	A5
	464	Auto-arm time extended	A6
	465	Panic alarm reset	A7
	466	Service ON/OFF premises	A8

Table 41: Ademco contact ID report codes (Continued)

Type	CID #	Reporting Code	Value
Sounder/Relay Disabled (520)	520	Sounder/relay disabled	A9
	521	Bell 1 disabled	AA
	522	Bell 2 disabled	AB
	523	Alarm relay disabled	AC
	524	Trouble relay disabled	AD
	525	Reversing relay disabled	AE
	526	Notification appliance chk. #3 disabled	AF
Modules (530)	527	Notification appliance chk. #4 disabled	B0
	531	Module added	B1
Communication Disabled (550 & 560)	532	Module removed	B2
	551	Dialer disabled	B3
Bypasses (570)	552	Radio transmitter disabled	B4
	570	Zone bypass	B5
	571	Fire bypass	B6
	572	24-hour zone bypass	B7
	573	Burglary bypass	B8
	574	Group bypass	B9
	575	Swinger bypass	BA
	576	Access zone shunt	BB
577	Access point bypass	BC	

Table 41: Ademco contact ID report codes (Continued)

Type	CID #	Reporting Code	Value
Test/Misc (600)	601	Manual trigger test	BD
	602	Periodic test report	BE
	603	Periodic RF transmission	BF
	604	Fire test	C0
	605	Status report to follow	C1
	606	Listen-in to follow	C2
	607	Walk test mode	C3
	608	Periodic test - system trouble present	C4
	609	Video transmitter active	C5
	611	Point test OK	C6
	612	Point not tested	C7
	613	Intrusion zone walk tested	C8
	614	Fire zone walk tested	C9
	615	Panic zone walk tested	CA
	616	Service request	CB
	621	Event log reset	CC
	622	Event log 50% full	CD
	623	Event log 90% full	CE
	624	Event log overflow	CF
	625	Time/date reset	D0
	626	Time/date inaccurate	D1
	627	Program mode entry	D2
	628	Program mode exit	D3
	629	32-hour event log marker	D4
	630	Schedule change	D5
	631	Exception schedule change	D6
632	Access schedule change	D7	
654	System inactivity	D8	

Automatic Report Codes

Table 42: List of automatic report codes

System Event	Default Contact ID Report Code		Default SIA Report Code	
Arming with user code (##)	3 4A1	Close by user	CL	Closing report
Auto arming	3 4A3	Automatic close	CA	Automatic closing
Late to close	3 452	Late to close	OT	Late to close
No movement	3 452	Late to close	NA	No activity
Partial arming	1 456	Group bypass	CG	Close area
Quick arming	3 4A8	Quick arm	CL	Closing report
Arm with PC software	3 4A7	Remote arm/disarm	CQ	Remote arming
Keyswitch arming	3 4A9	Keyswitch arming	CS	Keyswitch arming
Disarm with user code (##)	1 4A1	Open by user	OP	Opening report
Disarm after alarm with user code (##)	1 4A1	Open by user	OP	Opening report
Cancel alarm with user code (##)	1 4A6	Cancel by user	OR	Disarm from alarm
Auto arming cancellation	1 464	Deferred open/close	CE	Closing extend
Disarm with PC software	1 4A7	Remote arm/disarm	OQ	Remote disarming
Disarm after an alarm with PC software	1 4A7	Remote arm/disarm	OR	Disarm from alarm
Cancel alarm with PC software	1 4A6	Cancel by user	OR	Disarm from alarm
Cancel paramedic alarm	1 4A6	Cancel by user	MH	Medical alarm restore
Keyswitch disarm	1 4A9	Keyswitch disarm	OS	Keyswitch disarm
Keyswitch disarm after alarm	1 4A1	Keyswitch disarm after alarm	OS	Keyswitch disarm after alarm
Keyswitch cancel alarm	1 4A6	Keyswitch cancel alarm	OS	Keyswitch cancel alarm
Zone bypassed (##)	1 57A	Zone bypass	UB	Untyped zone bypass
Zone alarm (##)	1 13A	Burglary alarm	BA	Burglary alarm
Fire alarm (##)	1 11A	Fire alarm	FA	Fire alarm
Zone alarm restore (##)	3 13A	Burglary alarm restore	BH	Burglary alarm restore
Fire alarm restore (##)	3 11A	Fire alarm restore	FH	Fire alarm restore
24-hr gas alarm (##)	1 151	Gas detected	GA	Gas alarm
24-hr heat alarm (##)	1 153	Loss of heat	KA	Heat alarm
24-hr water alarm (##)	1 154	Water leakage	WA	Water alarm
24-hr freeze alarm (##)	1 152	Refrigeration	ZA	Freeze alarm
24-hr gas alarm restore (##)	3 151	Gas restore	GR	Gas alarm restore
24-hr heat alarm restore (##)	3 153	Heat restore	KR	Heat alarm restore
24-hr water alarm restore (##)	3 154	Water restore	WR	Water alarm restore
24-hr freeze alarm restore (##)	3 152	Freeze restore	ZR	Freeze alarm restore
24-hr hold-up alarm	1 12A	Panic alarm	PA	Panic alarm
24-hr hold-up alarm restore	3 12A	Panic alarm restore	PR	Panic restore
Panic 1: emergency	1 12A	Panic alarm	PA	Panic alarm
Panic 2: medical	1 1AA	Medical alarm	MA	Medical alarm
Panic 3: fire	1 115	Pull station	FA	Fire alarm
Recent closing	3 459	Open/close	CR	Recent closing
Global zone shutdown	1 575	Group bypass	CG	Close area
Duress alarm	1 121	Duress	HA	Hold-up alarm
Keypad lockout	1 421	Access denied	JA	User code tamper
Zone shutdown (##)	1 57A	Zone bypass	UB	Untyped zone bypass
Zone tampered (##)	1 144	Sensor tamper	TA	Tamper alarm
Zone tamper restore (##)	3 144	Sensor tamper restore	TR	Tamper restoral
TLM Trouble	1 351	Telco 1 fault	LT	Phone line trouble
AC failure	1 3A1	AC loss	AT	AC trouble
Battery failure	1 3A9	Battery test failure	YT	System battery trouble
Auxiliary supply trouble	1 3AA	System trouble	YP	Power supply trouble
Bell output current limit	1 321	Bell 1	YA	Bell fault

Table 42: List of automatic report codes (Continued)

<i>System Event</i>	<i>Default Contact ID Report Code</i>		<i>Default SIA Report Code</i>	
Bell absent	1 321	Bell 1	YA	Bell fault
Clock lost	1 626	Time/date inaccurate	JT	Time changed
Fire loop trouble	1 373	Fire trouble	FT	Fire trouble
Communication fail	1 354	Communication fail	YC	Fail to communicate
RF jamming	1 344	RF receiver jam detection	XQ	RF jamming
GPRS module RF interference	1 552	Radio transmitter disabled	YS	Communication trouble
GPRS network failure	1 552	Radio transmitter disabled	YS	Communication trouble
GPRS supervision lost	1 552	Radio transmitter disabled	YS	Communication trouble
GPRS fail to communicate	1 354	Communication fails	YC	Fail to communicate
IP network failure	1 552	Radio transmitter disabled	YS	Communication trouble
IP supervision lost	1 552	Radio transmitter disabled	YS	Communication trouble
IP fail to communicate	1 354	Communication fails	YC	Fail to communicate
TLM trouble restore	3 351	Telco 1 fault restore	LR	Phone line restoral
AC failure restore	3 3A1	AC loss restore	AR	AC restoral
Battery failure restore	3 3A9	Battery test restore	YR	System battery restoral
Auxiliary supply trouble restore	3 3AA	System trouble restore	YQ	Power supply restored
Bell output current limit restore	3 321	Bell 1 restore	YH	Bell restored
Bell absent restore	3 321	Bell 1 restore	YH	Bell restored
Clock programmed	3 625	Time/date reset	JT	Time changed
Fire loop trouble restore	3 373	Fire trouble restore	FJ	Fire trouble restore
Fail to communicate with monitoring station restore	3 354	Fail to communicate restore	YK	Communication fails restore
RF jamming restore	3 344	RF receiver jam detection restore	XH	RF jamming restoral
GPRS module RF interference restore	3 552	Radio transmitter restore	YK	Communication restore
GPRS network restore	3 552	Radio transmitter restore	YK	Communication restore
GPRS supervision restore	3 552	Radio transmitter restore	YK	Communication restore
GPRS fail to communicate restore	3 354	Communication restore	YK	Fail to communicate restore
IP network restore	3 552	Radio transmitter restore	YK	Communication restore
IP supervision restore	3 552	Radio transmitter restore	YK	Communication restore
IP fail to communicate restore	3 354	Communication restore	YK	Fail to communicate restore
Combus fault	1 333	Expansion module failure	ET	Expansion trouble
Module tamper	1 341	Expansion module tamper	TA	Tamper alarm
Module AC fail	1 342	AC failure on module	AT	Module AC fail
Module battery fail	1 338	Battery failure on module	YT	Module battery fail
Bus fault restore	3 333	Expansion module failure restore	ER	Expansion restoral
Module tamper restore	3 341	Expansion module tamper restore	TR	Tamper restoral
Module AC fail restore	3 342	AC restored on module	AR	Module AC fail restore
Module battery fail restore	3 338	Battery failure on module	YR	Module battery fail restore
Cold start	1 3A8	System shutdown	RR	Power up
Test report engaged	1 6A2	Periodic test report	TX	Test report
PC software communication finished	1 412	Successful - download access	RS	Remote program success
Installer on site	1 627	Program mode entry	LB	Local program
Installer programming finished	1 628	Program mode exit	LS	Local program success
Maintenance in	1 627	Program mode entry	LB	Local program
Maintenance out	1 628	Program mode exit	LS	Local program success
Closing delinquency	1 654	System inactivity	CD	System inactivity
Manual trigger test in	1 6A1	Manual trigger test in	TS	Manual trigger test in
Manual trigger test out	3 6A1	Manual trigger test out	TS	Manual trigger test out
Exit error	1 374	Exit error	EE	Exit error
RF module low battery	1 384	RF transmitter low battery	XT	Transmitter battery trouble
RF module battery restore	3 384	RF transmitter battery restore	XR	Transmitter battery restoral

Table 42: List of automatic report codes (Continued)

System Event	Default Contact ID Report Code		Default SIA Report Code	
RF zone supervision lost	1 381	Loss of supervision - RF	US	Untype zone supervision
RF zone supervision restore	3 381	Supervision restore - RF	UR	Untyped zone restoral
RF module supervision lost	1 381	Loss of supervision - RF	US	Untyped zone supervision
RF module supervision restore	3 381	Loss of supervision - RF restore	UR	Untyped zone restoral
RF module tamper	1 145	Expansion module tamper	ES	Expansion device tamper
RF module tamper restore	3 145	Expansion module tamper restore	EJ	Expansion device restore
Paramedic alarm	1 1AA	Medical	MA	Medical alarm
Zone forced	1 57A	Zone forced	XW	Zone forced
Zone included	3 57A	Zone included	UU	Zone included
Remote low battery	1 338	Battery failure on module	YT	Module battery fail
Remote low battery restore	3 338	Battery failure on module restore	YR	Module battery fail restore
Failed to arm	1 454	Failed to close	CI	Failed to close

Communication Report Codes

Use worksheet 45 to record your settings for communication report codes. Sections [879] and [884] apply to network GPRS communications. See *Communication Programming* on page 41, for more communication features. In addition, refer to *Description of Sections [966] and [967]* on page 53, for clearing and resetting codes.

Worksheet 45: Communication Report Codes

Section	Data	Description
[879]	___/___	PCS series RF jam
	___/___	PCS series no service
	___/___	PCS series module supervision lost
	___/___	Receiver fail to communicate (GPRS)

Section	Data	Description
[880]	___/___	-
	___/___	IP Module no service
	___/___	IP Module supervision lost
	___/___	IP receiver fail to communicate

Section	Data	Description
[884]	___/___	N/A
	___/___	-
	___/___	-

Communication Restore Report Codes

Use worksheet 46 to record your settings for communication restore report codes. Section [881] applies to network GPRS communications.

Worksheet 46: Communication Restore Report Codes

Section	Data	Description
[881]	___/___	PCS series RF jam
	___/___	PCS series no service
	___/___	PCS series module supervision lost
	___/___	Receiver fail to communicate (GPRS)

Section	Data	Description
[882]	___/___	-
	___/___	IP Module no service
	___/___	IP Module supervision lost
	___/___	IP receiver fail to communicate

Software Options and Additional Timers

Use the following section to program software options and additional communication timers on your SP+ control panel.

Table 43: Description of section [900] (BabyWare options)

Section	Option	Description	OFF	ON
[900]	1	Call back	▲ Disabled	<input type="checkbox"/> Enabled
	2	Automatic event buffer transmission	▲ Disabled	<input type="checkbox"/> Enabled

▲ = Default

Additional Communication Timers

Use worksheet 47 to record your settings for sections [901] and [902]. For additional timers, see worksheets 38 and 39.

Worksheet 47: Additional Communication Timers

Section	Data	Description	Default
[901]	___/___/___	000 to 255 rings	008
[902]	___/___/___	000 to 255 secs. (max 127)	030

BabyWare Options

Use worksheet 48 to record your settings for BabyWare options.

Worksheet 48: BabyWare Options

Section	Data	Description
[910]	___/___/___/___	Panel ID
[911]	___/___/___/___	PC password
[915]	___/___/___/___/___/___/___/___/___/___/___/___/___/___/___/___	PC telephone number (landline communication only)

NOTE: For increased communication security, you will be prompted to change the default panel ID and PC password.

IP and Software Configurations

Use the following section to configure IP and software requirements on your SP+ control panel.

IP Account Numbers

Use worksheet 49 to record the IP account numbers for network communication.

Worksheet 49: IP Account Numbers

Section	Data	Description
[918]	___/___/___/___	IP account partition 1
[919]	___/___/___/___	IP account partition 2

Software and PCS Connection Settings

Use worksheet 50 to record connection settings for BabyWare and PCS series.

Worksheet 50: Software and PCS Connection Settings

Section	Data	Description	Default
[920]	___/___/___/___	Port	10000
[921]	___/___/___/___/___/___/___/___/___/___/___/___/___/___/___/___	Access point name (APN), part 1 (e.g., <i>internet.com</i>)	-
[922]	___/___/___/___/___/___/___/___/___/___/___/___/___/___/___/___	Access point name (APN), part 2	-
[923]	___/___/___/___/___/___/___/___/___/___/___/___/___/___/___/___	User name, part 1	-
[924]	___/___/___/___/___/___/___/___/___/___/___/___/___/___/___/___	User name, part 2	-
[925]	___/___/___/___/___/___/___/___/___/___/___/___/___/___/___/___	Password, part 1	-
[926]	___/___/___/___/___/___/___/___/___/___/___/___/___/___/___/___	Password, part 2	-
[927]	___/___/___/___/___/___/___/___/___/___/___/___/___/___/___/___	Installer software password (BabyWare)	admin

IP Receiver Configurations

Use worksheets 51 to 53 (on page 52) to configure IP receivers. Table 44 provides a description of the IP/GPRS registration status.

Table 44: IP/GPRS registration status

Key	Main Menu Trouble	Key	Sub-menu Trouble
1	IP/GPRS module registration status	1	OFF = Unregistered
		1	Slow flash = Registering
		1	ON = Registration OK
2	IP/GPRS module error	7	No IP/GPRS module
		8	Ethernet cable unplugged; PCS no service
		9	No IP address acquired by module/GPRS network trouble
3	IP/GPRS programming error	7	No IP address (not programmed)
		8	No IP port (not programmed)
		9	No IP account (not programmed)
		10	No access point name (not programmed; GPRS only)
4	IP/GPRS registration error	7	Cannot connect
		8	Invalid profile
		9	Invalid format
		10	Account already registered under another MAC address
Register module		-	When all troubles are cleared, press ARM to register module

Worksheet 51: IP Receiver 1 Configuration

Section	Data	Description	Default
[929]	____.____.____.____	WAN1 IP address (e.g., 100.100.100.100); for one or two-digit numbers, add 0s before the first digit	-
[930]	____	WAN1 IP port	10000
[931]	____.____.____.____	WAN2 IP address	-
[932]	____	WAN2 IP port	10000
[933]	____	IP password	123456
[934]	__	IP profile (e.g., 01)	-
[935]	To view status or to register, press ARM (see table 44 on page 51)		IP receiver status

Worksheet 52: IP Receiver 2 Configuration

Section	Data	Description	Default
[936]	____.____.____.____	WAN1 IP address (e.g., 100.100.100.100)	-
[937]	____	WAN1 IP port	10000
[938]	____.____.____.____	WAN2 IP address	-
[939]	____	WAN2 IP port	10000
[940]	____	IP password	123456
[941]	__	IP profile (e.g., 01)	-
[942]	To view status or to register, press ARM (see table 44 on page 51)		IP receiver status

Worksheet 53: IP Receiver Backup Configuration

Section	Data	Description	Default
[943]	____.____.____.____	WAN1 IP address (e.g., 100.100.100.100)	-
[944]	____	WAN1 IP port	10000
[945]	____.____.____.____	WAN2 IP address	-
[946]	____	WAN2 IP port	10000
[947]	____	IP password	123456
[948]	__	IP profile (e.g., 01)	-
[949]	To view status or to register, press ARM (see table 44 on page 51)		IP receiver status

Usability Sections

The sections described in the ensuing segment are used to clear, reset, and display various settings and features on your SP+ control panel.

Description of Sections [950], [955], and [960]

Table 45: Description of sections [950], [955], and [960]

Section	Description
[950]	Resets all programmable sections to their respective factory-set, default values. Once accessed, press ENTER to reset.
[951]	Sets panel for EN 50131 compliancy. To set the panel, enter section [951] and press ENTER .
[955]	Clears bus module troubles. Once cleared, remove disconnected module from the bus.
[960]	Displays the wireless transmitter serial number. Once accessed, press any button on the assigned remote control, or press the tamper switch of the download memory key. Press ENTER to view the next digit.

Description of Section [965]

Table 46: Description of section [965] (reset labels)

	Option	Description	OFF	ON
Section [965]	1	Reset zone labels	<input type="checkbox"/> Disabled	<input checked="" type="checkbox"/> Enabled
	2	Reset user labels	<input type="checkbox"/> Disabled	<input checked="" type="checkbox"/> Enabled
	3	Reset partition labels	<input type="checkbox"/> Disabled	<input checked="" type="checkbox"/> Enabled
	4	Reset PGM labels	<input type="checkbox"/> Disabled	<input checked="" type="checkbox"/> Enabled
	5	Reset bus module labels	<input type="checkbox"/> Disabled	<input checked="" type="checkbox"/> Enabled
	6	Reset wireless repeater and siren labels	<input type="checkbox"/> Disabled	<input checked="" type="checkbox"/> Enabled
	7	Reset wireless keypad, repeater, and siren labels	<input type="checkbox"/> Disabled	<input checked="" type="checkbox"/> Enabled

▲ = Default

NOTE: When resetting any option in section **[965]**, ensure that all other options are deselected. Press **ENTER** to reset the respective set of labels to their default values, before exiting the section.

Description of Sections [966] and [967]

Table 47: Description of sections [966] and [967] (clear and reset report codes)

	Option	Description	OFF		ON	
Section [966]	1	Clear zone report codes	<input type="checkbox"/>	Disabled	▲	Enabled
	2	Clear user report codes	<input type="checkbox"/>	Disabled	▲	Enabled
	3	Clear arm/disarm/alarm report codes	<input type="checkbox"/>	Disabled	▲	Enabled
	4	Clear trouble report codes	<input type="checkbox"/>	Disabled	▲	Enabled
	5	Clear system special report codes	<input type="checkbox"/>	Disabled	▲	Enabled
	6	Clear report code for PCS lost communication with panel	<input type="checkbox"/>	Disabled	▲	Enabled

	Option	Description	OFF		ON	
Section [967]	1	Reset zone report codes to default	<input type="checkbox"/>	Disabled	▲	Enabled
	2	Reset user report codes to default	<input type="checkbox"/>	Disabled	▲	Enabled
	3	Reset arm/disarm/alarm report codes to default	<input type="checkbox"/>	Disabled	▲	Enabled
	4	Reset trouble report codes to default	<input type="checkbox"/>	Disabled	▲	Enabled
	5	Reset system special report codes to default	<input type="checkbox"/>	Disabled	▲	Enabled
	6	Reset report code for PCS lost communication with panel	<input type="checkbox"/>	Disabled	▲	Enabled

▲ = Default

NOTE: When clearing or resetting any option in sections [966] AND [967], ensure that all other options are deselected. Press **ENTER** to reset the respective set of labels to their default values, before exiting the section.

Description of Sections [970], [975], and [980]

Table 48: Description of sections [970], [975], and [980]

Section	Description
[970]	Downloads data from the memory key to the control panel. To download data, enter section [970], and then press ENTER .
[975]	Uploads data from the control panel to the memory key. To upload data, enter section [975], and then press ENTER .
[980]	Displays version number of the control panel. Once accessed, press ENTER to view the next digit.

Label Programming with LCD Keypads

Use the information in the following section to program system labels, using an LCD keypad (K32LCD+).

Function keys

Table 49: Description of the special function keys, used for programming labels on LCD keypads

Function	Keypad Key
Insert space	STAY
Delete	SLEEP
Delete entire entry	ARM
Toggle between numeric and alphanumeric keys	OFF
Toggle between lower and upper case keys	BYP
Insert special characters	ENTER

Keypad Letter Assignments

The following section outlines the different configurations for keypad letter assignments, including those in Hebrew, Greek, and Russian.

Table 50: Standard keypad letter assignment

Key	Press Key Once	Press Key Twice	Press Key Three Times
1	A	B	C
2	D	E	F
3	G	H	I
4	J	K	L
5	M	N	O
6	P	Q	R
7	S	T	U
8	V	W	X
9	Y	Z	

Table 51: Greek keypad letter assignment

Key	Press Key Once	Press Key Twice	Press Key Three Times
1	C	D	I
2	F	G	\
3	J	S	K
4	M	N	O
5	P	Ξ	Q
6	R	T	U
7	V	W	H
8	E	[Y

Figure 6: Hebrew keypad letter assignment

Key	Press key once	Press key twice	Press key three times
[1]	א	ב	ג
[2]	ד	ה	ו
[3]	ז	ח	ט
[4]	י	כ	ל
[5]	מ	נ	ס
[6]	ע	פ	ק
[7]	ר	ש	ת
[8]			
[9]			

Figure 7: Russian keypad letter assignment

Key	Press key once	Press key twice	Press key three times	Press key four times
[1]	А	Б	В	Г
[2]	Д	Е	Ё	Ж
[3]	З	И	Й	К
[4]	Л	М	Н	О
[5]	П	Р	С	Т
[6]	У	Ф	Х	Ц
[7]	Ч	Ш	Щ	Ъ
[8]	Ы	Ь	Э	Ю
[9]	Я			

Trouble Display

The following section provides information on the different troubles associated with your SP+ control panel. To view the trouble display, press **TBL** on your SP+ keypad. Table 52 outlines the troubles appearing in the main menu and their corresponding sub-menu troubles. To view the sub-menu troubles, press the trouble's respective key in the main menu.

NOTE: Keypads can be programmed to emit a beep every five seconds, whenever a new trouble condition has occurred. Press **TBL** to stop the beeping.

Table 52: Description of troubles for SP+ control panels

Key	Main Menu Trouble	Key	Sub-menu Trouble
1	Wireless zone low battery	1 to 32	Zones in low battery
2	Power trouble	1	Low/no battery on the control panel
		2	AC failure on control panel
		3	Auxiliary overload on control panel
		4	Wireless keypad AC failure
		5	Wireless keypad battery failure
		6	Wireless repeater AC failure
		7	Wireless repeater battery failure
		8	Wireless siren AC failure
		9	Wireless siren battery failure
		10	Remote low battery (press [0] to view which remote)
3	Bell trouble	1	Bell disconnected on control panel
		2	Bell overload on control panel

Table 52: Description of troubles for SP+ control panels

4	Communication trouble	1	Telephone line monitoring on control panel
		2	Fail to communicate on monitoring telephone 1, on control panel
		3	Fail to communicate on monitoring telephone 2, on control panel
		5	Fail to communicate on voice telephone, on control panel
		6	Fail to communicate with PC, on control panel
		7	Fail to communicate with IP receiver 1 or 2 (GPRS)
		8	Fail to communicate with IP receiver 1 or 2 (IP)
		9	N/A
		10	IP module no service (network failure)
		STAY	PCS RF jamming
		OFF	IP receiver unregistered (IP/GPRS)
		5	Tamper and zone wiring failure
	STAY	Panel tamper supervision	
6	Module tamper trouble	1	2WPGM
		2	Keypad bus
		3	ZX8/ZX82 bus module
		4	RTX3 bus module
		5	Wireless siren
		6	GPRS module
7	Fire loop trouble	1 to 32	Zones in fire loop trouble
8	Timer loss	-	
9	Wireless zone supervision loss	1 to 32	Zones in supervision lost
		STAY	RF jamming trouble
0 (10), or 10	Module supervision loss	1	2WPGM
		2	Keypad bus (panel reset will not clear this trouble; clear it in section [955])
		3	ZX8/ZX82 bus module
		4	RTX3 bus module
		5	Wireless keypad
		6	Wireless repeater
		7	-
		8	VDMP3
		9	PCS series
		10	IP Module
		STAY	Wireless siren
16	Keypad fault (K32, K32RF, K37, K35 only)	-	
SLEEP	Keypad fault (K636, K10V/H only)	-	

Hardware Connections

Programmable Output Connections

When a specific event occurs in the system, a PGM can reset smoke detectors, activate strobe lights, open/close garage doors and much more.

PGMs

The control panels include two/four on-board programmable outputs (PGMs). PGM1 and PGM2 can support up to 150 mA. The PGMs are limited by the power source being used. If powered by:

- **The AUX terminals.** The current consumption of the AUX terminals cannot exceed 700 mA. Therefore, whatever devices are connected to the AUX terminals (e.g., modules and PGMs) cannot exceed 700 mA combined. For example, if there are six modules connected to the AUX terminals that are using 600 mA and you wish to power the PGM using the AUX terminals, the PGM's current consumption cannot exceed 100 mA.
- **An external power supply.** If using an external power supply, the current consumption cannot exceed 150 mA for PGM1 and PGM2. If the external power supply's current consumption limit is less than that of the PGM it is connected to, than the current consumption will not exceed the power supply's current limit.

Single Zone Inputs

Detection devices such as motion detectors and door contacts are connected to the control panel's zone input terminals. Figure 6 demonstrates single zone input terminal connections recognized by the panel. Once connected, the associated zone's parameters must be defined.

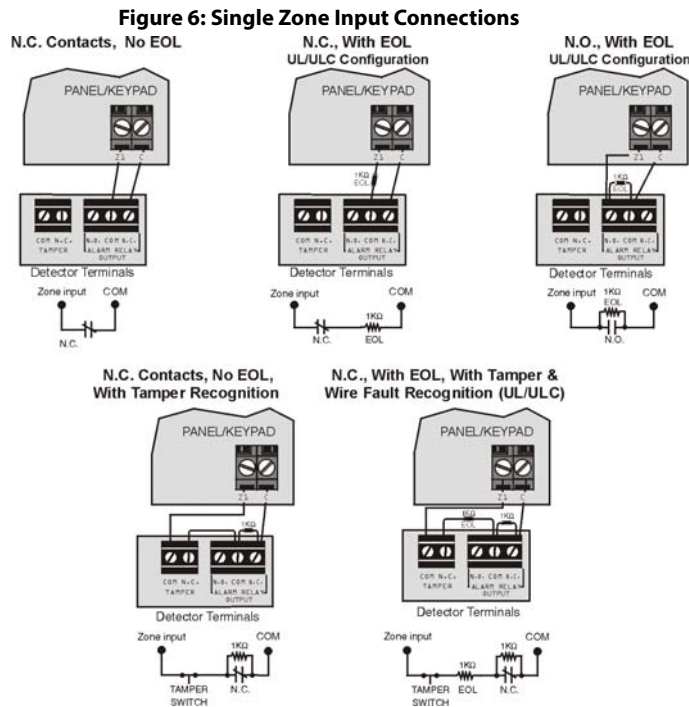

Advanced Technology Zone (ATZ) Connections (SP6000+ only)

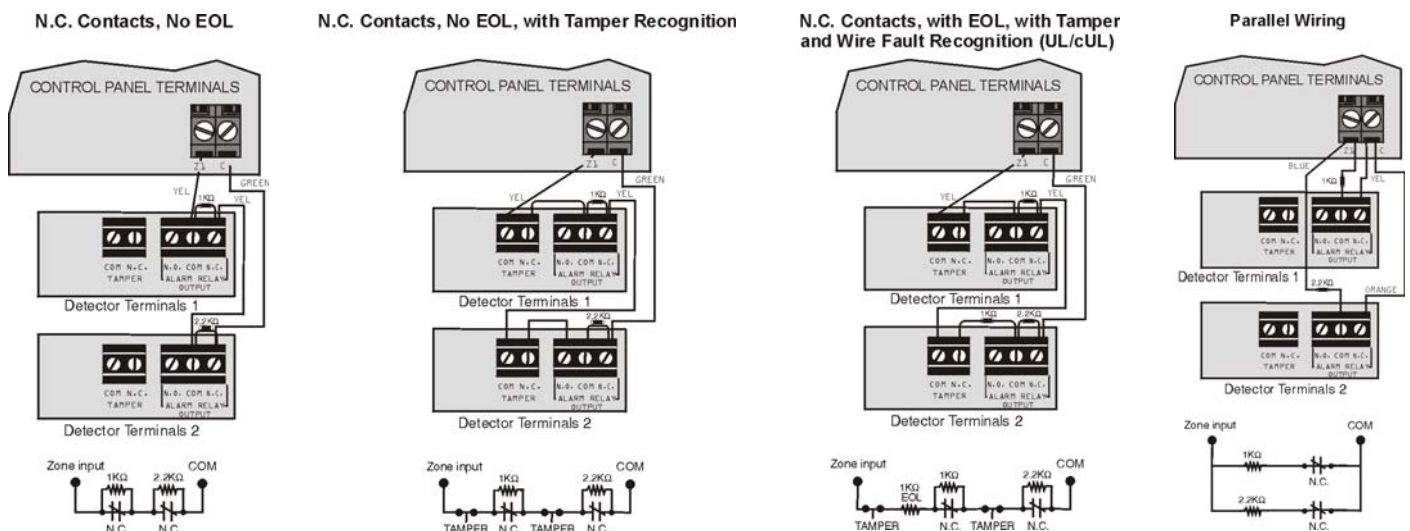

Fire Circuits

When a zone is programmed as a fire zone, the zone becomes normally open and requires an EOL resistor. If a line short occurs or if the smoke detector becomes active, whether the system is armed or disarmed, the control panel will generate an alarm. If a trouble occurs on a fire zone, the Fire Loop Trouble will appear in the keypad's trouble display (See "Trouble Display" on page 55.) and the control panel can transmit the Fire Loop Trouble report, if programmed, in section [866].

Figure 7: Fire Circuits

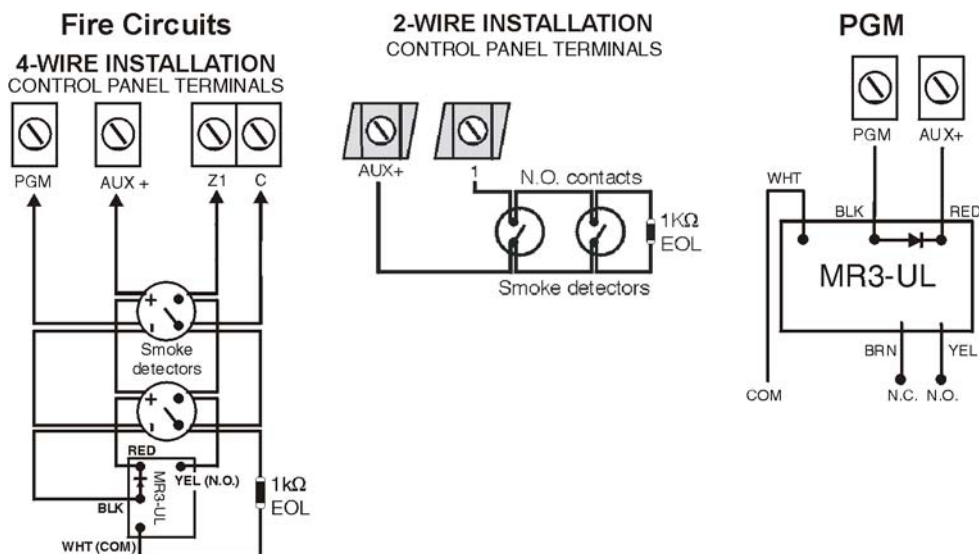

AC Power

Do not use any switch-controlled outlets to power the transformer to avoid accidental user AC shut off. Connect the transformer as shown in Figure 1. Use the below table for appropriate transformer.

Use only a safety approved transformer with rated output voltage of 16.5 Vac and rated power of 40 VA (minimum).

	SP5500+	SP6000+	SP7000+
Transformer: (use only one of the following)	16.5 VAC 40 VA (minimum)		
Panel DC power supply output rated at:	700 mA	1A	1.5A
Maximum allowed current supplied by all Auxiliary outputs:	1.1A	1.5A	1.75A
Battery Charge Currents	700 mA		

Backup Battery

To provide power during a power loss, connect a 12 Vdc 7 Ah or 4 Ah rechargeable lead acid or gel cell battery. Verify proper polarity as reversed connections will blow the battery fuse.

Use only safety approved rechargeable battery with rated voltage of 12 Vdc and rated current of 7A maximum.

Battery Test

If the battery is disconnected or if the battery fuse is blown, a No/Low Battery failure will appear in the keypad's trouble display (See "Trouble Display" on page 55.). This trouble will also appear if the battery's capacity is too low or if the voltage drops to 10.5V or lower while the control panel is running on the backup battery. At 8.5V or lower, the panel shuts down and all outputs close. A battery protection disconnect occurs at 9.1 volts. If output voltage drops below 11.3 volts, a fault signal is generated.

Demonstration or Emergency System Power-up without an AC Source

To power-up the control panel for demonstration or emergency purposes only, use a standard 12 VDC, 4 Ah/7 Ah backup battery. To power the control panel using a backup battery:

1. Connect the battery to the control panel's **BATT** terminal.
2. Use a wire to short the battery's negative terminal to the panel's **AUX-** terminal.

SP5500+ PCB Layout

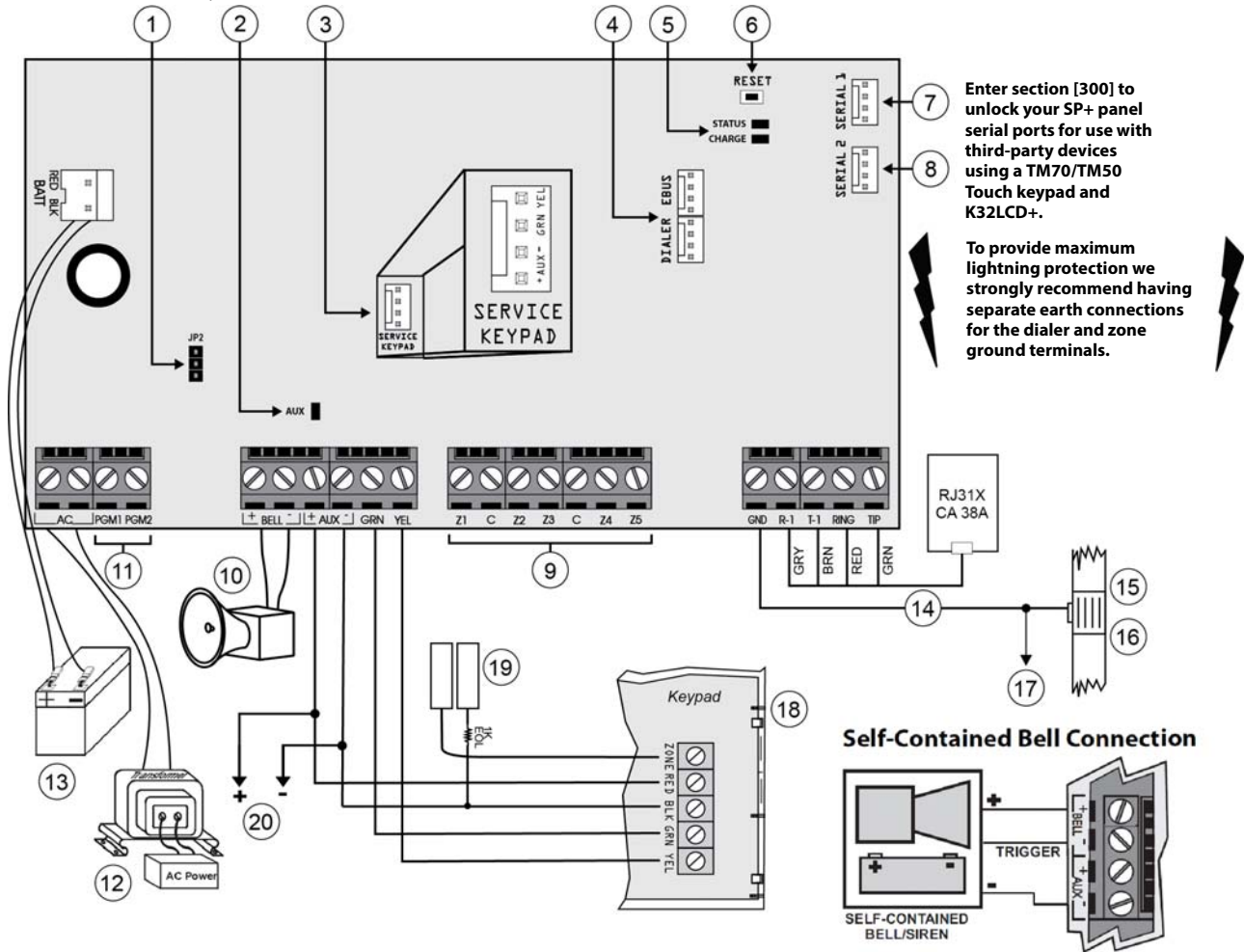

Enter section [300] to unlock your SP+ panel serial ports for use with third-party devices using a TM70/TM50 Touch keypad and K32LCD+.

To provide maximum lightning protection we strongly recommend having separate earth connections for the dialer and zone ground terminals.

- | | |
|---|---|
| 1 | PGM Jumper: allows you to choose whether the solid state relay PGMs are ground (-), or give out 12V (+) |
| 2 | AUX LED:
• ON = Aux present; OFF = Aux off |
| 3 | Four-pin connector can be used for quick installation of a keypad |
| 4 | EBUS and Dialer used with:
• VDMP3 Plug-In Voice Module for voice reporting
• PCS Series Communicator Module |
| 5 | LEDs
Status LED:
• Flash once every second: Normal
• Flashes ON 1 sec. and OFF 1 sec.: Any trouble
• Always ON: Panel is using phone line
• Fast flash 6 seconds after power-up: Installer lock enabled
Charge LED:
Charging and battery test LED |
| 6 | Panel reset |
| 7 | Serial 1: Used as the primary reporting channel for connecting the IP Module/PCS Module |
| 8 | Serial 2: Used as a backup reporting channel for connecting the IP Module/PCS Module |

- | | |
|----|--|
| 9 | Zone Input |
| 10 | The BELL output will shutdown if the current exceeds 3A |
| 11 | PGM output connector |
| 12 | AC Power connections |
| 13 | Backup Battery connections |
| 14 | AWG#14 single conductor solid copper wire |
| 15 | Ground clamp |
| 16 | Cold water pipe grounding |
| 17 | To ground |
| 18 | Keypad's zone configuration |
| 19 | Zone connections, if EOL is enabled, see section [706] option 2 |
| 20 | To connect additional wiring to auxiliary power, use the red (+) and black (-) keypad connectors; auxiliary power will shut down if current exceeds 1.1A; if the auxiliary output is overloaded and shuts down, you must disconnect all loads from the output for at least 10 sec. before reconnecting any load back to the auxiliary output |



The sum of the current drawn from the BELL and AUX must be limited to 1.3A. Exceeding this limit will overload the panel power supply and lead to complete system shutdown.

40 VA transformer strongly recommended.

This equipment must be installed and maintained by qualified service personnel only.

Max. number of keypads: 15 bus modules

Max. aux. current: 700 mA

Power consumption (idle): 52 mA

Max. distance of bus module from panel: 76 m (250 ft.)

Max. total run of wire: 230 m (750 ft.)

SP6000+ PCB Layout

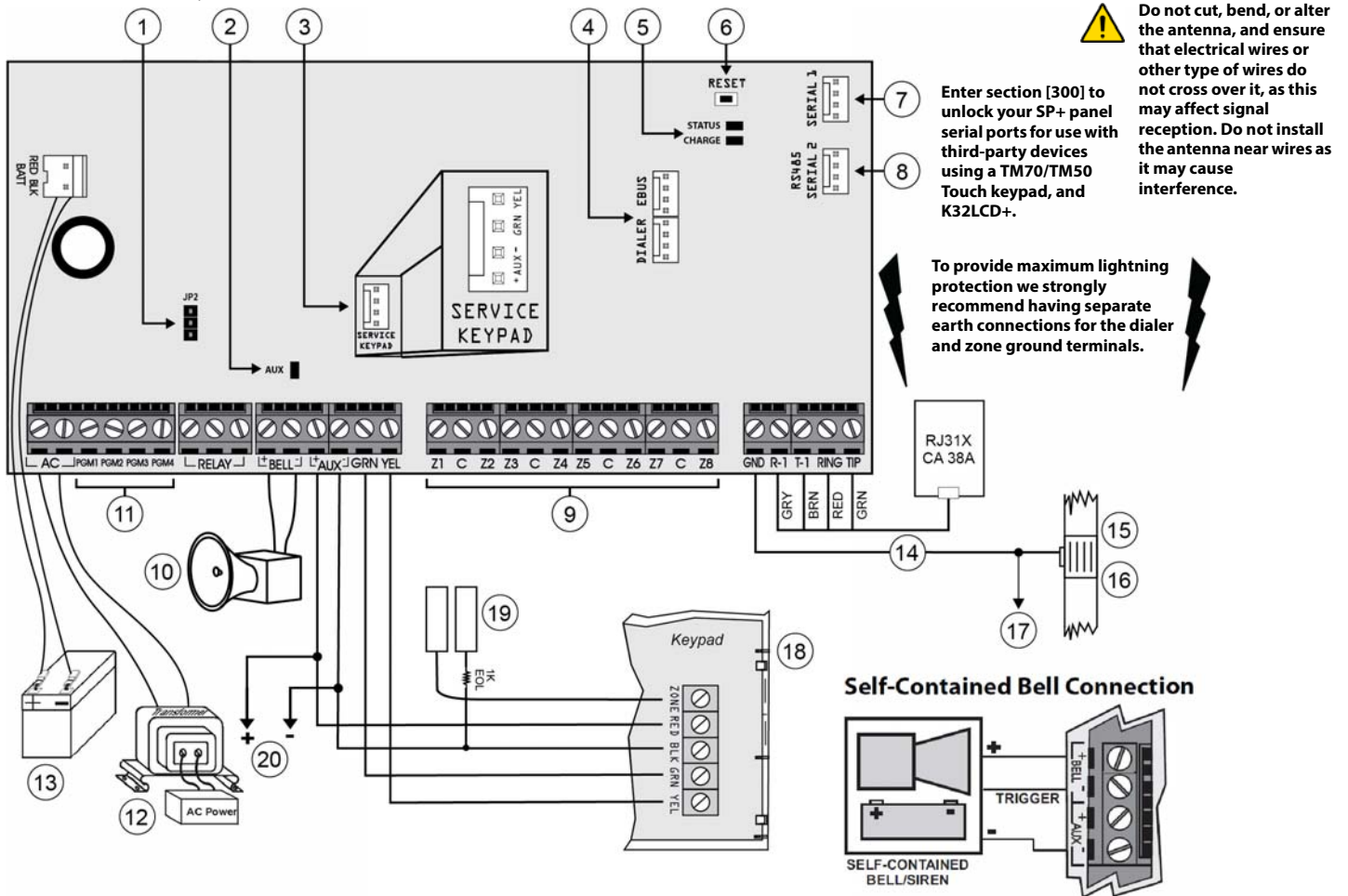

1	PGM Jumper: allows you to choose whether the solid state relay PGMs are ground (-), or give out 12V (+)
2	AUX LED: • ON = Aux present; OFF = Aux off
3	Four-pin connector can be used for quick installation of a keypad
4	EBUS and Dialer used with: • VDMP3 Plug-In Voice Module for voice reporting • PCS Series Communicator Module
5	LEDs Status LED: • Flash once every second: Normal • Flashes ON 1 sec. and OFF 1 sec.: Any trouble • Always ON: Panel is using phone line • Fast flash 6 seconds after power-up: Installer lock enabled Charge LED: Charging and battery test LED
6	Panel reset
7	Serial 1: Used as the primary reporting channel for connecting the IP Module/PCS Module
8	Serial 2: Used as a backup reporting channel for connecting the IP Module/PCS Module

9	Zone Input
10	The BELL output will shutdown if the current exceeds 3A
11	PGM output connector
12	AC Power connections
13	Backup Battery connections
14	AWG#14 single conductor solid copper wire
15	Ground clamp
16	Cold water pipe grounding
17	To ground
18	Keypad's zone configuration
19	Zone connections, if EOL is enabled, see section [706] option 2
20	To connect additional wiring to auxiliary power, use the red (+) and black (-) keypad connectors; auxiliary power will shut down if current exceeds 1.1A; if the auxiliary output is overloaded and shuts down, you must disconnect all loads from the output for at least 10 sec. before reconnecting any load back to the auxiliary output



The sum of the current drawn from the BELL and AUX must be limited to 1.6A. Exceeding this limit will overload the panel power supply and lead to complete system shutdown.

40 VA transformer strongly required.

This equipment must be installed and maintained by qualified service personnel only.

Max. number of keypads: 15 bus modules

Max. aux. current: 1000 mA

Power consumption (idle): 55 mA

Max. distance of bus module from panel: 76 m (250 ft.)

Max. total run of wire: 230 m (750 ft.)

SP7000+ PCB Layout

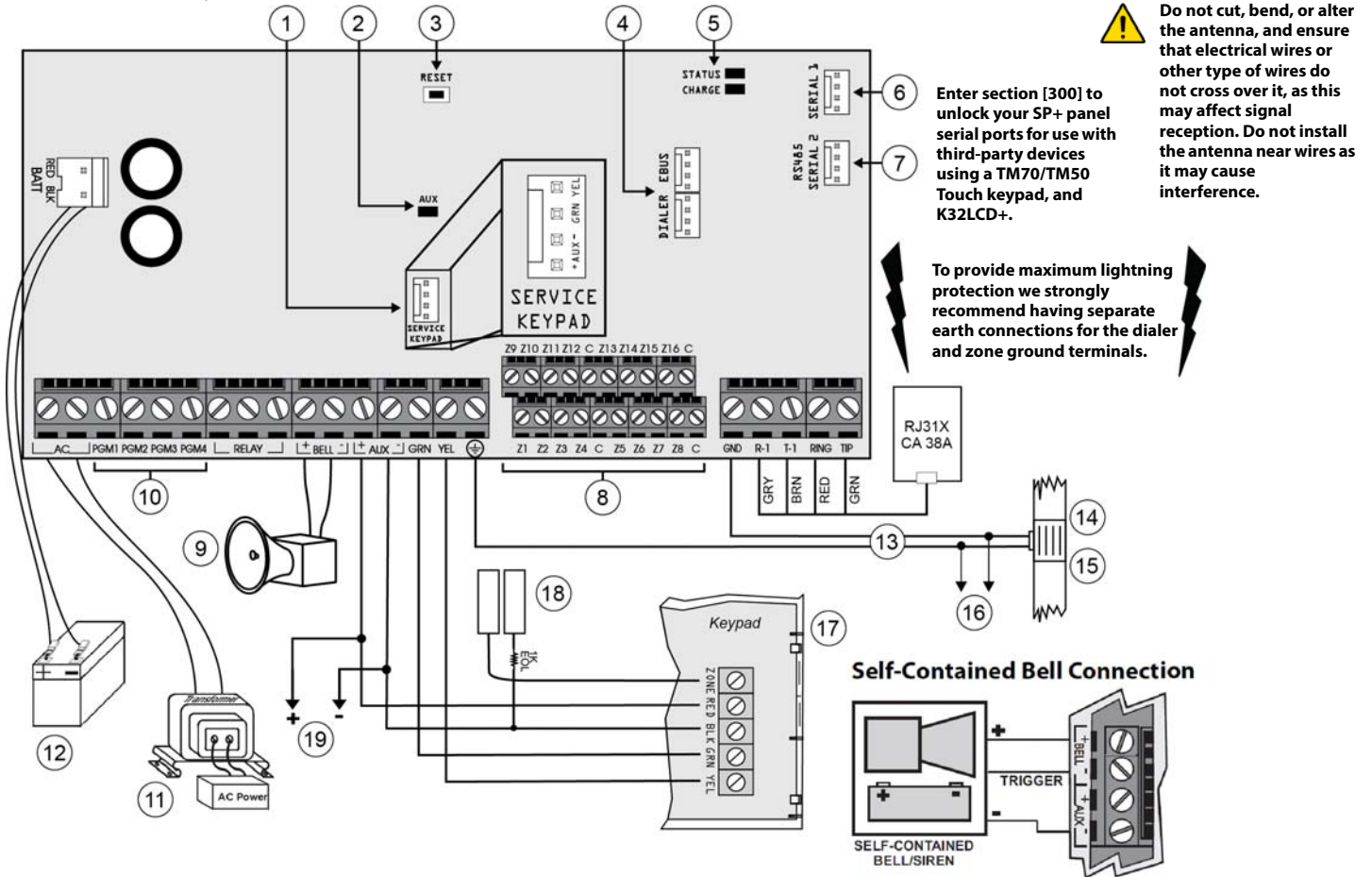

1	Four-pin connector can be used for quick installation of a keypad
2	AUX LED: • ON = Aux present; OFF = Aux off
3	Panel reset
4	EBUS and Dialer used with: • VDMP3 Plug-In Voice Module for voice reporting • PCS Series Communicator Module
5	LEDs Status LED: • Flash once every second: Normal • Flashes ON 1 sec. and OFF 1 sec.: Any trouble • Always ON: Panel is using phone line • Fast flash 6 seconds after power-up: Installer lock enabled Charge LED: Charging and battery test LED
6	Serial 1: Used as the primary reporting channel for connecting the IP Module/PCS Module
7	Serial 2: Used as a backup reporting channel for connecting the IP Module/PCS Module

8	Zone Input
9	The BELL output will shutdown if the current exceeds 3A
10	PGMs: these jumpers allow you to choose whether the solid state relay PGMs are grounded (-), or give out 12V (+)
11	AC Power connections
12	Backup Battery connections
13	AWG#14 single conductor solid copper wire
14	Ground clamp
15	Cold water pipe grounding
16	To ground
17	Keypad's zone configuration
18	Zone connections, if EOL is enabled, see section [706] option 2
19	To connect additional wiring to auxiliary power, use the red (+) and black (-) keypad connectors; auxiliary power will shut down if current exceeds 1.1A; if the auxiliary output is overloaded and shuts down, you must disconnect all loads from the output for at least 10 sec. before reconnecting any load back to the auxiliary output



The sum of the current drawn from the BELL and AUX must be limited to 2.1A. Exceeding this limit will overload the panel power supply and lead to complete system shutdown.

40 VA transformer strongly required.

This equipment must be installed and maintained by qualified service personnel only.

Max. number of keypads: 15 bus modules

Max. aux. current: 1500mA

Power consumption (idle): 46mA

Max. distance of bus module from panel: 76 m (250 ft.)

Max. total run of wire: 230 m (750 ft.)

Appendix A

EN 50131 Programming

The following sections describe all the programming required for your panel to be EN 50131 compliant.

To set your panel to be EN 50131 compliant:

1. Enter section [951] to unlock the software and set EN 50131 defaults.
2. Press Enter.

NOTE: All keypads in the system must have anti-tamper enabled in order to be EN 50131 compliant.

EN 50131 Standard System Defaults

The following sections provide the system defaults that will be set for EN50131 compliance. The following provides information on sections [700] through [840].

Table 53: Description of section [700]

Section	Option	Option Type	Description	OFF		ON	
Section [700]	1	Partitioning	Partitioning	▲	Disabled	<input type="checkbox"/>	Enabled
	2	General system options	Battery charging	▲	350mA	<input type="checkbox"/>	700mA
	3		Audible trouble warning (except AC failure)	▲	Disabled	<input type="checkbox"/>	Enabled
	4		Audible trouble warning on AC failure	▲	Disabled	<input type="checkbox"/>	Enabled
	5	RF jamming supervision	RF jamming supervision	<input type="checkbox"/>	Disabled	▲	Enabled
	6	General system options	Exit delay termination	▲	Disabled	<input type="checkbox"/>	Enabled
	7		Tamper supervision on the bus module	<input type="checkbox"/>	Disabled	▲	Enabled
	8	Panel Tamper	Panel Tamper Supervision	<input type="checkbox"/>	Disabled	▲	Enabled

Table 54: Description of section [703]

Section	Option	Option Type	Description	OFF		ON	
Section [703]	1	Keypad options 2	One-touch regular arming (also REM3)	▲	Disabled	<input type="checkbox"/>	Enabled
	2		One-touch stay arming (also REM3)	▲	Disabled	<input type="checkbox"/>	Enabled
	3		One-touch sleep arming (also REM3)	▲	Disabled	<input type="checkbox"/>	Enabled
	4		One-touch bypass programming	▲	Disabled	<input type="checkbox"/>	Enabled
	5	Arming/disarming options	Restrict arming on battery failure	▲	Disabled	<input type="checkbox"/>	Enabled
	6		Restrict arming on tamper failure (zone + bus module + wireless PGM)	▲	Disabled	<input type="checkbox"/>	Enabled
	7		Restrict arming on supervision trouble; wireless zones & PGM + bus module	▲	Disabled	<input type="checkbox"/>	Enabled
	8	Future Use	-	-	-	-	-

ATZ, Zone Tamper and Supervision Options

Table 55: Description of section [705]

	Option	Description	OFF		ON	
Section [705]	1	ATZ zone doubling	▲	Disabled	<input type="checkbox"/>	Enabled
	2	ATZ wiring options	▲	Series	<input type="checkbox"/>	Parallel
	3	Tamper recognition (see following table)	<input type="checkbox"/>	Disabled	▲	Enabled
	4		▲	Disabled	<input type="checkbox"/>	Enabled
	5	Generate tamper on bypassed zone	<input type="checkbox"/>	No	▲	Yes
	6	Supervision options (see following table)	<input type="checkbox"/>	Disabled	▲	Enabled
	7		▲	Disabled	<input type="checkbox"/>	Enabled
	8	Generate supervision on bypassed zone	<input type="checkbox"/>	No	▲	Yes

▲ = Default

Table 56: Description of options 3 & 4 and 6 & 7, in section [705]

Option		Description	
3	4	RF Zone/Hardwired Zone Tamper Recognition Options	Keypad/Bus Module Tamper Recognition Options*
OFF	OFF	Disabled	Disabled
OFF	ON	Trouble only	Trouble only
ON	OFF	When disarmed: trouble only; when armed: follow zone's alarm type	Trouble only
ON	ON	When disarmed: audible alarm; when armed: follow zone's alarm type	Audible alarm
6	7	RF Zone Supervision Options	Keypad/Bus Module Supervision Options
OFF	OFF	Disabled	Disabled
OFF	ON	Trouble only	Trouble only
ON	OFF	When disarmed: trouble only; when armed: follow zone's alarm type	Trouble only
ON	ON	When disarmed: audible alarm; when armed: follow zone's alarm type	Audible alarm

* Tamper recognition of keypad/bus module, only if section [700], option 7, is enabled.

General Zone Options

Table 57: Description of section [706]

	Option	Description	OFF		ON	
	Section [706]	1	Check-in supervision time	<input type="checkbox"/>	24 hours	<input checked="" type="checkbox"/>
2		EOL resistors (applies to all hardwired zones – panel, keypad, ZX8/ZX82)	<input type="checkbox"/>	Disabled	<input checked="" type="checkbox"/>	Enabled
3		Zone input 1 becomes a two-wire smoke input	<input checked="" type="checkbox"/>	Disabled	<input type="checkbox"/>	Enabled
4		ZX8/ZX82 ID A (panel + 1) input 1	<input type="checkbox"/>	Zone input	<input checked="" type="checkbox"/>	Tamper input
5		ZX8/ZX82 ID B (panel + 9) input 1	<input type="checkbox"/>	Zone input	<input checked="" type="checkbox"/>	Tamper input
6		ZX8/ZX82 ID C (panel + 17) input 1	<input type="checkbox"/>	Zone input	<input checked="" type="checkbox"/>	Tamper input

▲ = Default

Miscellaneous System Options

Table 58: Description of section [708]

	Option	Description	OFF		ON	
	Section [708] EN50131 OPTIONS	1	Enter code to view trouble	<input type="checkbox"/>	One-touch	<input checked="" type="checkbox"/>
2		Enter code to view alarm in memory/event list	<input type="checkbox"/>	One-touch	<input checked="" type="checkbox"/>	Enter code
3		Trouble latch	<input type="checkbox"/>	Disabled	<input checked="" type="checkbox"/>	Enabled
4		Bell squawk on Installer in	<input type="checkbox"/>	Disabled	<input checked="" type="checkbox"/>	Enabled
5		Acknowledge trouble(s) before arming	<input type="checkbox"/>	Disabled	<input checked="" type="checkbox"/>	Enabled
6		Do not arm if zone opens during exit delay	<input type="checkbox"/>	Disabled	<input checked="" type="checkbox"/>	Enabled
7		Disable 'Bypass and Arm'	<input type="checkbox"/>	Disabled	<input checked="" type="checkbox"/>	Enabled
8		Future use	-	-	-	-

▲ = Default

Unlock Panel Serial Ports

Enter section [300] to unlock your SP+'s panel serial ports for use with third-party devices using a TM70/TM50 Touch keypad and the K32LCD+. For a step-by-step procedure, refer to the Insite Gold Installer Menu Guide.

System Timers

Worksheet 54: System Timers

Section	Data	Description	Section	Data	Description
[710]	___/___/___ 000 to 255 seconds	Entry delay 1* (default: 045)	[718]	___/___/___ 000 to 255 seconds	Remote panic disarm lock delay (default: 000)
[711]	___/___/___ 000 to 255 seconds	Entry delay 2* (default: 045)	[719]	___/___/___ 000 to 255 days	Closing delinquency delay (default: 000)
[712]	___/___/___ 000 to 015	Auto-zone shutdown counter (default: 005)	[720]	___/___/___ 000 to 255 seconds	Flex-instant delay (default: 015)
[713]	___/___/___ 000 to 255 seconds	Intellizone delay (default: 048)	[721]	___/___/___ 000 to 255 seconds	For StayD: re-arm delay (default: 005)
[714]	___/___/___ 000 to 255 minutes	Recycle alarm delay (default: 000)	[722]	___/___/___ 000 to 255 seconds	Auto trouble shutdown** (default: 010)

Worksheet 54: System Timers

Section	Data	Description	Section	Data	Description
[715]	___/___/___ 000 to 255	Recycle alarm counter (default: 000)	[723]	___/___/___ 000 to 255 seconds (default: 010)	Panic shutdown**

* For EN 50131, the maximum value is 45 seconds.
** For EN 50131, the section must be set to a minimum of 3 and a maximum of 10

Keypad Lockout

Use the following section to program keypad lockout settings for your SP+ control panel. Use worksheet 30 to record your settings.

Worksheet 55: Keypad Lockout

Section	Data	Description	Default
[716]	___/___/___ 000 to 255 minutes	Keypad lockout delay	015 minutes
[717]	___/___/___ 000 to 255 attempts before locking	Keypad lockout counter	005 attempts

NOTE: For EN 50131, the keypad lockout value must be set between three and ten attempts. The minimum delay to lock must be two minutes.

Dialer Options

Table 59: Description of section [801]

Option	Description		OFF		ON	
Section [801]	1	Report system disarming	<input type="checkbox"/>	Always	▲	After alarm
	2	Report zone restore on closure	<input type="checkbox"/>	Bell cutoff	▲	Zone closure
	3 & 4	Auto-test report transmission	▲	Disabled	<input type="checkbox"/>	Enabled
	5	Contact ID override	▲	Disabled	<input type="checkbox"/>	Enabled
	6	Future use				
	7	Future use				
	8	Future use				

▲ = Default

Timers

Use worksheet 38 to record your settings for sections [820] to [840].

Worksheet 56: Communication Timers

Section	Data	Description	Default
[820]	___/___/___ 000 to 255 hours	Fail to comm. clear event timer	000 = disabled
[830]	___/___/___ 000 to 255 x 2 seconds	TLM fail delay (landline only)	016
[831]	___/___/___ 000 to 032	Maximum dialing attempts monitoring station (landline only)	002
[832]	___/___/___ 000 to 127 seconds	Delay between dialing attempts* (landline only)	020
[833]	___/___/___ 000 to 255 seconds	Delay alarm transmission	000
[838]	___/___/___ 000 to 255 seconds	Recent closing delay	000
[839]	___/___/___ 000 to 255 minutes	Power failure report delay**	015
[840]	___/___/___ 000 to 255 days	Auto test report (see table 36 on page 41)	001

* Also applicable when using a VDMP3 Plug-in Voice Dialer.s

**The maximum value for power failure is 60 minutes.

Notes

The whole Paradox team wishes you a successful and easy installation. We hope this product performs to your complete satisfaction.

Should you have any questions or comments, please contact us at support@paradox.com.

Additional information can be found on our website www.paradox.com/support

P ▲ R ▲ D O X™

Printed in Canada - 06/2022

PARADOX.COM

SP+030-EP00