

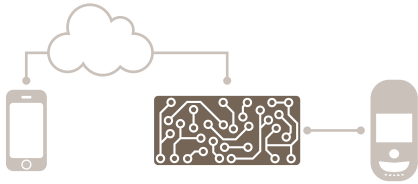

EVOHD



Installation Guide

Includes Keypad Installation

Version 1.11 and higher

P ▲ R ▲ D O X™



www.paradox.com

Warranty

For complete warranty information on this product please refer to the Limited Warranty Statement found on our Web site: www.paradox.com. Your use of this Paradox product signifies your acceptance of all warranty terms and conditions.

© 2002-2014 Paradox Ltd. All rights reserved. Specifications may change without prior notice. One or more of the following patents may apply: 2,292,187 and RE#39406.

Digiplex, Digiplex EVO, Magellan, and BabyWare are trademarks or registered trademarks of Paradox Ltd. or its affiliates in Canada, the United States and/or other countries. For the latest information on products approvals, such as UL and CE, please visit www.paradox.com.

Manufactured at Paradox Security Systems in Montreal, Canada J7R 5V3.

Limitations of Alarm Systems

It must be understood that while your Paradox alarm system is highly advanced and secure, it does not offer any guaranteed protection against burglary, fire or other emergency (fire and emergency options are only available on certain Paradox models). This is due to a number of reasons, including but not limited to inadequate or improper installation/positioning, sensor limitations, battery performance, wireless signal interruption, inadequate maintenance or the potential for the system or telephone lines to be compromised or circumvented. As a result, Paradox does not represent that the alarm system will prevent personal injury or property damage, or in all cases provide adequate warning or protection.

Your security system should therefore be considered as one of many tools available to reduce risk and/or damage of burglary, fire or other emergencies, such other tools include but are not limited to insurance coverage, fire prevention and extinguish devices, and sprinkler systems.

We also strongly recommend that you regularly maintain your security systems and stay aware of new and improved Paradox products and developments.

Warning for Connections to Non-Traditional Telephony (e.g., VoIP)

Paradox alarm equipment was designed to work effectively around traditional telephone systems. For those customers who are using a Paradox alarm panel connected to a non-traditional telephone system, such as Voice Over Internet Protocol (VoIP) that converts the voice signal from your telephone to a digital signal traveling over the Internet, you should be aware that your alarm system may not function as effectively as with traditional telephone systems.

For example, if your VoIP equipment has no battery back-up, during a power failure your system's ability to transmit signals to the central station may be compromised. Or, if your VoIP connection becomes disabled, your telephone line monitoring feature may also be compromised. Other concerns would include, without limitation, Internet connection failures which may be more frequent than regular telephone line outages.

We therefore strongly recommend that you discuss these and other limitations involved with operating an alarm system on a VoIP or other non-traditional telephone system with your installation company. They should be able to offer or recommend measures to reduce the risks involved and give you a better understanding.

Table of Contents

Introduction	4
Features of EVOHD	4
Hardware Summary	4
Specifications	4
EN 50131 Compliance	4
Installation	5
Recommended Installation Procedure	5
Location & Mounting	5
EVOHD Control Panel Installation	5
Earth Ground	5
AC Power	5
Backup Battery	5
Auxiliary Power Terminals	5
Bell/Siren Output	5
Programmable Outputs	5
Keyswitch Connections	5
Access Control Connections	5
Keypad Installation (K641/K641R/K641+)	5
Keypad Specifications (K641/K641R/K641+ only)	5
Calculating Power Requirements	7
Keypad Zone Connections	9
Addressable Zone Connections	10
Double Zone Connections	11
Digiplex Bus Connections	11
Fire Circuits	11
Telephone Line Connections	12
Programming Methods	13
BabyWare Uploading/Downloading Software*	13
Module Broadcast	13
Programming Through a Keypad	13
Module Programming Mode	13
Zone Programming	14
Zone Programming	15
Zone Numbering	15
Zone Doubling (ATZ)	15
Zone Definitions	15
Zone Partition Assignment	16
Zone Options	16
Input Speed	17
EOL on Hardwire Zones	18
Selectable Input Resistor	18
Keypad Numbering	18
Remote Control Programming	19
Hardware Requirements	19
Remote Control Template	19
Remote Control Templates	19
Keyswitch Programming	21
Keyswitch Numbering	21
Keyswitch Definitions	21
Keyswitch Partition Assignment	21
Keyswitch Options	21
Arming and Disarming Options	22
Arming Follows Partition	22
Trouble Latch	22
Restrict Arming on Supervision Loss	22
Restrict Arming on Tamper	22
Restrict Arming on AC Failure	22
Restrict Arming on Battery Failure	22
Restrict Arming on Bell or Auxiliary Failure	22
Restrict Arming on TLM Failure	22
Restrict Arming on Module Troubles	22
Restrict Arming on Anti Mask Troubles	22

Timed Auto-Arming	22
No Movement Auto-Arming	23
Auto-Arming Options	23
Switch To Stay Arming	23
Always Force Arm when Regular Arming	23
Auto Force on Stay Arming	23
Follow Zone Switches to Entry Delay 2	23
One-Touch Features	23
Exit Delay	23
Keypad Lock-out Feature	24
Bell Squawk	24
Ring-back	24
Maximum Bypass Entries	24
Display "Bypass" If Armed	24
Alarm Options	25
Bell/alarm Output	25
Bell Cut-off Timer	25
Wireless Transmitter Supervision Options	25
Police Code Timer	25
Tamper Recognition Options	25
Keypad Panic Options	26
Event Reporting	27
Reporting Enabled	28
IP/GSM / GPRS Reporting	28
Report Codes	28
Report Arming and Disarming	30
Monitoring Station Phone Number	30
Account Number	30
Account Number Transmission	30
Reporting Formats	30
Event Call Direction	31
Pager Delay	31
Recent Close Delay	31
Power Failure Report Delay	31
Power Failure Restore Report Delay	31
Repeat Pager Report Code Transmission	31
Auto Test Report	32
Disarm Reporting Options	32
Zone Restore Report Options	32
Auto Report Code Programming	32
Closing Delinquency Timer	32
Dialer Options	33
Telephone Line Monitoring	33
Tone/Pulse Dialing	33
Pulse Ratio	33
Busy Tone Detection	33
Switch To Pulse	33
Bell On Communication Fail	33
Keypad Beep on Successful Arm or Disarm Report	33
Dial Tone Delay	33
VDMP3 Voice Module	34
VDMP3 Installation Instructions	34
Feature activation (PGMs)	34
VDMP3 Setup Instructions	34
Programmable Outputs	35
PGM Activation Event	35
PGM Deactivation Option	35
Flexible PGM Deactivation Option	35
PGM Deactivation Event	35
PGM Timer	35
PGM1 Becomes a 2-wire Smoke Detector Input*	35
PGM Test Mode	35
PGM Initial Status	35
System Settings and Commands	36

Hardware Reset	36
Software Reset	36
Installer Code Lock	36
Daylight Savings Time	36
Daylight Savings Time Schedule	36
Digiplex bus Speed	36
Transmit Zone Status on Serial Port	36
Partitioning	36
Shabbat Feature	36
Installer Function Keys	37
Module Reset	37
Locate Module	37
Module Programming	37
Module and Label Broadcast	37
System Date & Time	37
Quick Module Scanning	37
Module Scanning	37
Serial Number Viewing	37
Power Save Mode	37
Auto Trouble Shutdown	37
No AC Fail Display	37
Multiple Action Feature	37
System Labels	38
Access Codes	40
Installer Code	40
Access Code Length	40
System Master Code	40
Programming Access Codes	40
User Options	40
Partition Assignment	41
Access Control	41
Access Control: System Features	42
Common Access Control Terms	42
Programming Overview	42
Enable Access Control	42
Door Numbering	42
Access Levels	42
Access Schedules	42
Backup Schedules	42
Holiday Programming	42
Schedule Tolerance Window	42
Door Access Mode	43
Code Access	43
Card and Code Access	43
Skip Exit Delay When Arming With Access Card	43
Restrict Arming on Door	43
Restrict Disarming on Door	43
Door Access During Clock Loss	43
Burglar Alarm On Forced Door or Door Left Open	43
Logging Access Control Events	43
BabyWare Software	44
Panel Identifier	44
PC Password	44
PC Telephone Number	44
Call Back Feature	44
Call BabyWare	44
Answering Machine Override Delay	44
Ring Counter	44
Event Buffer Transmission	44
In-Field Firmware Upgrade	44
Appendix 1: Automatic Report Code List	46
Appendix 2: Contact ID Report Code List	49
Appendix 3: Keypad Installation Instructions	51

Introduction

The Digiplex EVOHD is a security and access control system with 8 on-board zone inputs (16 with zone doubling) that is expandable to 192 zones via the 4-wire Digiplex bus. The EVOHD control panel features up to 999 users, 8 partitions, 32 doors and can support up to 254 modules in any combination.

The Digiplex EVOHD system provides the highest level of protection for banks, high-security military and government sites, luxurious residential homes and any place where maximum security is essential. These systems are designed to be easy to use, and the modular concept of these systems provides installers with labour-saving features that make expanding, installing and servicing these systems quick and convenient.

Expand the EVOHD system by adding plug-and-play expansion modules anywhere and in any combination on the 4-wire Digiplex bus. Modules are connected to the Digiplex bus at the most convenient location and then their zone inputs are assigned to the desired zone and partition. Also, only a module's used inputs are assigned to zones in the system. Keyswitches, remote controls and unused module inputs do not use up zones. Once installed, all Digiplex bus modules, including motion detectors, can be programmed remotely via a keypad or the BabyWare upload/download software.

EVOHD also supports 32 virtual zones in addition to its security zones and access control doors. Virtual zones can be used to automate PGM activations without occupying a security zone and without affecting the system's security functions. The EVOHD system is a logical solution to every installer's security, access control and home automation installation needs.

Features of EVOHD

- ◆ Digital bus:
 - Provides constant power, supervision and two-way communication between the control panel and all its modules
 - Supports up to 254 expansion bus modules
 - Connect modules up to 914m (3000ft) from the panel
 - Sabotage-proof technology without additional wiring
- ◆ Expandable to 192 zones
- ◆ Support for HD77 Camera
- ◆ Built-in access control features
- ◆ In-field firmware upgradeable via 307USB (or IP150) and BabyWare
- ◆ Compatible with NEware
- ◆ Automatic Daylight Saving Time feature
- ◆ 3 on-board solid-state PGM outputs, negative or positive triggering
- ◆ PGM1 can be used as a 2-wire smoke input
- ◆ 1 Form C relay output with N.O and N.C. contacts.
- ◆ 999 user codes
- ◆ 8 partitions
- ◆ 2048 events buffered
- ◆ Program remote controls using the master or installer codes
- ◆ Up to 999 remote controls with one RTX3
- ◆ Built-in-real-time clock
- ◆ 2.5A switching power supply
- ◆ 1 supervised bell output, auxiliary output and telephone line
- ◆ Separate Tamper switch input
- ◆ Fits in a 28cm x 28cm x 7.6cm (11in x 11in x 3in) metal box
- ◆ Dimensions: 9.5cm X 20.2cm (3.75in X 7.94in); Weight: 0.49 lbs. (0.22 kg)

Important Installation Considerations

- ◆ Maximum Peak to peak ripple voltage on AUX is 500 millivolts.
- ◆ Low voltage on the battery generated when battery is below 11.5 volts
- ◆ Deep discharge protection on the battery operates 10.5 ± 0.3 volts.
- ◆ Overvoltage protection triggered at 15.5 volts
- ◆ If output voltage drops below 11.3 volts a fault is signal is generated.

Hardware Summary

Feature	EVOHD
Zones	192
Partitions	8
Users	999
On-board PGMs*	5
Modules	254

Specifications

Control Panel

AC Power:	16Vac, 40/75VA, 50-60Hz
Consumption:	100mA
Battery:	12Vdc, 7Ah minimum
Auxiliary Power:	0.8A typical, 2.0A maximum, fuseless shutdown at 2.5A
Bell Output:	2A, fuseless shutdown @ 2.5A
PGM Output:	PGM1: Open collector output, PGM2,3 and 4 100mA solid-state relays with +/- trigger, PGM5 Form C relay output rated at 5A/28Vdc N.O. / N.C.
Operational Temperature:	-10°C to +55°C (14°F to +133°F)
Weight and Dimensions in EN metal enclosure:	28.5 x 30 x 8 cm (11 x 11 x 3 In.); 5.2 kg (11.4 lbs)

All control panel outputs are rated to operate between 10.8Vdc and 12.1Vdc

Accessories current *	30hrs backup	60hrs backup	Recharge to 80% (@850mA)
7AHr	130mA	N/A	3.7 hrs.
17AHr	470mA	183mA	9 hrs.
35AHr	1170mA	583mA	18.7 hrs.

*modules current is the sum or the current consumed by all modules (keypads, detectors, VDMP3...)

Control Panel (UL compliant systems)

AC Power:	16Vac, 40/75VA, 60Hz
Battery:	12Vdc, 7Ah minimum
Auxiliary Power:	0.6A typical, 1.0A maximum, fuseless shutdown at 2.5A
Bell Output:	11.4 to 12.5Vdc, 1A maximum, fuseless shutdown @ 3A
PGM Output:	PGM1 to PGM4 100mA solid-state relays with +/- trigger, PGM5 Form C relay output rated at 5A/28Vdc N.O. / N.C.
Humidity:	5 - 90%

All control panel outputs are rated to operate between 11.4Vdc and 12.5Vdc

Specifications may change without prior notice. For latest product specifications and standards, please visit www.paradox.com.

EN 50131 Compliance

In order to meet with EN 50131 compliancy, you will require the following:

- EN Metal Box
- TK278 Tamper kit

Standards:EN50131-1 Security Grade 3, Environmental Class II; EN 50131-3; EN 50131-6 Type A - use a 9Ah battery; EN 50131-5-3 (for RTX3); EN 50136-1 SP2; EN 501036-2 for on-board PSTN

For more details on how to set up your panel for EN compliancy, please refer to the EVOHD Programming Guide.

Installation

Recommended Installation Procedure

1. Connect a small group of modules, including a keypad. See *Figure 5* on page 6 for connection information.
2. Connect the battery and AC power. Enter section [4000] (see *section* on page 37). Only the Clock Loss trouble and/or Bell Absent trouble should appear. Verify the connection if a module does not appear in section [4000], or if a module trouble occurs.
3. Disconnect AC power and the battery, follow steps 2, 3 and 4 for other modules.
4. If modules were removed, enter [4005] (see *section* on page 37).
5. Connect an LCD keypad at various points from the control panel and use the keypad's built-in voltmeter.

NOTE: To comply with 50131 requirements, unit must be installed in an approved tamper enclosure.

Location & Mounting

Select a site that is not accessible to intruders and leave at least 2" around the box to allow proper ventilation and heat dissipation. The site should be dry and close to an AC, ground and telephone line connection.

EVOHD Control Panel Installation

Once the location of the box has been completed, install the panel as illustrated.

Figure 1: EVOHD Installation

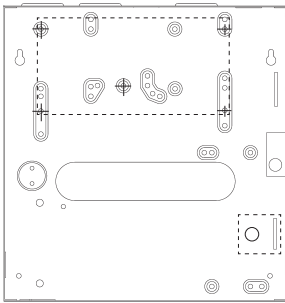

Installation of TK278 tamper kit
(use single screw to attach bracket to wall)

Earth Ground

Connect the ground connector to the enclosure and cold water pipe or grounding rod as per local electrical codes.

AC Power

Use a transformer with a minimum 40VA rating. For increased power use a 75VA rating. With a 40VA transformer, Battery charging is limited to 750mA and auxiliary output is limited to 1 Amp. With a 75VA transformer, the battery charge can be set to 1.5Amp and the auxiliary can reach 2 Amp. For UL Listed systems, use model #BE156240CAA. For CSA listed systems, use model #BE116240AAA. Do not use any switch-controlled outlets to power the transformer. Depending on the transformer being used, you must program the panel accordingly. Enter section [3002] to program the correct transformer (default is set to 75 VA).

NOTE: Do not connect the transformer or the backup battery until all wiring is completed. When powering up the EVOHD control panel, the panel will begin a module scan.

WARNING: You must program the correct transformer size (Ex: 40VA, 75VA). Using a transformer with a lower VA than the one programmed may overload.

Backup Battery

Connect a 12Vdc 7Ah rechargeable acid/lead or gel cell backup battery (YUASA model #NP7-12 recommended). Verify the polarity, as reversed connections will blow the battery fuse.

Battery Test

The control panel conducts a dynamic battery test under load every 60 seconds. If the battery is disconnected, if its capacity is too low or if the battery voltage drops to 11.5 volts or less when there is no AC, the "Battery Trouble" message will appear in the Trouble Display. At 10.5 volts, the panel shuts down and all outputs close.

Auxiliary Power Terminals

The auxiliary power supply can power accessories in the security system. A fuseless circuit protects the auxiliary output against overload and shuts it down if the current exceeds 2.5A. Auxiliary power will resume once the overload condition has restored.

Bell/Siren Output

The bell output supplies 12Vdc upon alarm and can support one 30-watt or two 20-watt sirens. The bell output will automatically shut down if the current exceeds 3A. If the load on the BELL terminals returns to normal ($\leq 3A$), the control panel will re-instate power to the BELL terminals. Please verify correct polarity.

NOTE: For connection of self-contained bell/siren, see *Figure 5* on page 6.

WARNING: When the bell output is not used, the "Bell Absent" message appears in the Trouble Display. To avoid this, connect a 1k Ω resistor across the bell output. UL Note: The keypads must be programmed to beep with all troubles.

Programmable Outputs

PGM2 to PGM4 are 100mA (max.) solid state relays with +/- trigger. PGM1 is an open collector output that can be used to monitor two wire smoke detectors. PGM5 is a 5A/28Vdc N.O./N.C. relay output. They can be set at either normally open or normally closed. If the current draw on PGM1 to PGM4 is to exceed the current output, we recommend using a relay as shown in *Figure 2*.

Figure 2: PGM & Relay

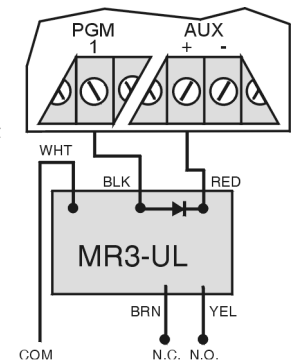

Keyswitch Connections

Connect the keyswitches to the keypad, control panel, or Zone Expansion Module's hardwired input terminals as shown in *Figure 3*.

Figure 3: Keyswitch

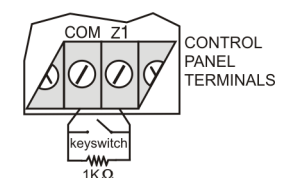

Access Control Connections

For all access control explanations and connection drawings, refer to *Access Control: System Features* on page 42.

Keypad Installation (K641/K641R/K641+)

Depending on the type of installation, select the appropriate mounting holes and secure with appropriate number of screws.

Keypad Specifications (K641/K641R/K641+ only)

The following specifications apply for the K641, K641R, and K641+ keypads only.

Dimensions: 12.2 cm x 14.4cm 4.8in x 5.67

Weight: 0.26 kg (0.58 lbs.)

Humidity: 5 - 90%

Standards: EN 50131-1 EN 50131-3 Grade 3 Class II

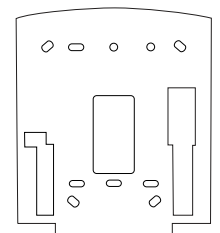
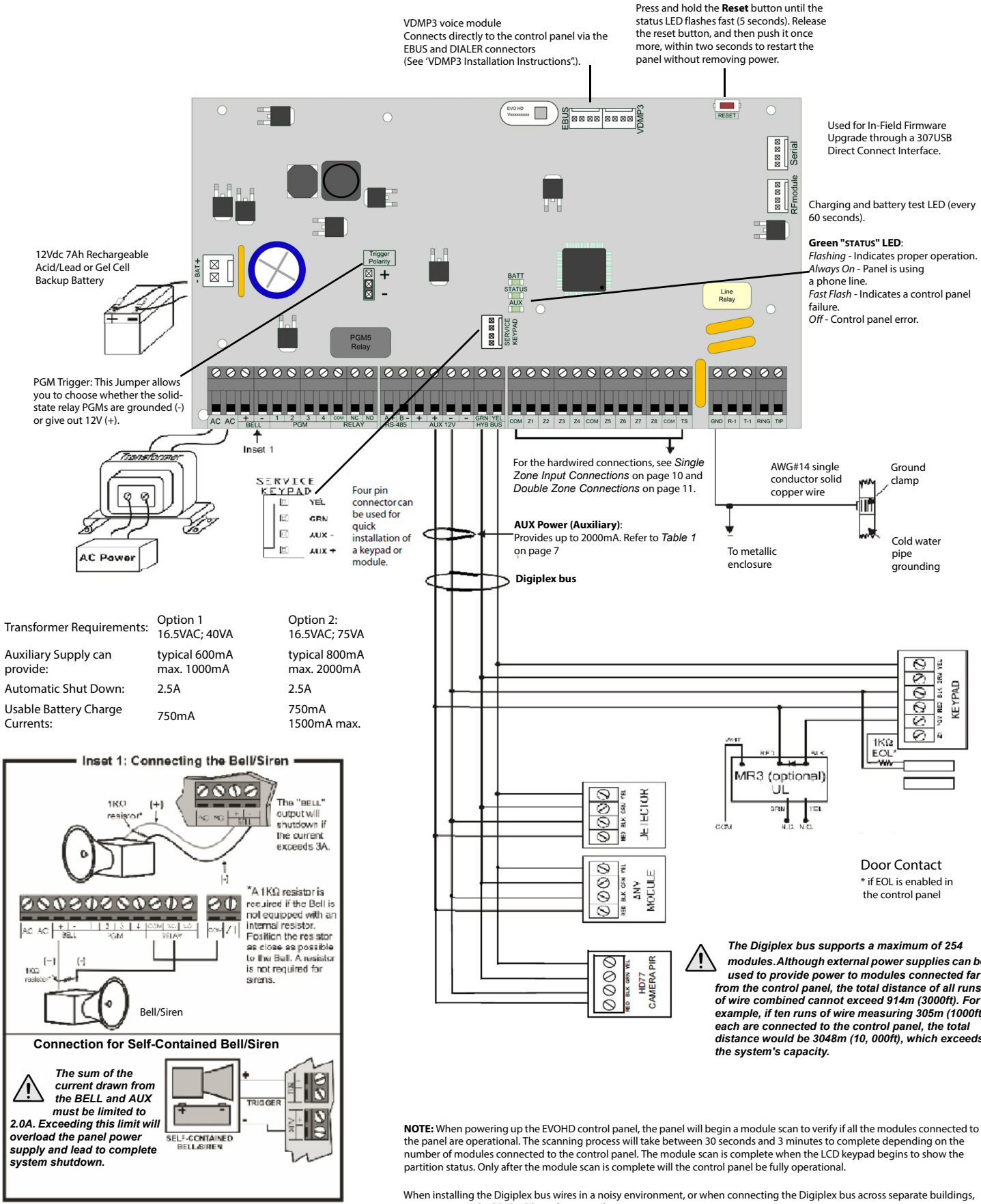

Figure 4: Keypad Installation

Figure 5: EVOHD Control Panel Wiring Diagram



NOTE: When powering up the EVOHD control panel, the panel will begin a module scan to verify if all the modules connected to the panel are operational. The scanning process will take between 30 seconds and 3 minutes to complete depending on the number of modules connected to the control panel. The module scan is complete when the LCD keypad begins to show the partition status. Only after the module scan is complete will the control panel be fully operational.

When installing the Digiplex bus wires in a noisy environment, or when connecting the Digiplex bus across separate buildings, you must use a shielded cable. Refer to *section* on page 11.

Please see *CTR-21 Warnings* on page 59 for applicable UL/ULC warnings and information.

40VA transformer strongly recommended

Calculating Power Requirements

Table 1: Milliamp Consumption of Various Devices

Device	QTY.	Consumption for Each	Total mA
HD77 Camera	_____	x 330 mA	_____
Communicator Module(PCS250/G)	_____	x 450 mA	_____
LCD keypads (K641, K656, K641LX)	_____	x 110 mA	_____
LCD keypads with built-in reader (K641R, K641+)	_____	x 120 mA	_____
Motion detector modules (DG85, DM50/60/70)	_____	x 30 mA	_____
Door contact modules (ZC1)	_____	x 15 mA	_____
1-Zone expansion modules (ZX1)	_____	x 30 mA	_____
4-Zone expansion modules (ZX4)	_____	x 30 mA	_____
8-Zone expansion modules (ZX8)	_____	x 30 mA	_____
8-Zone expansion modules (ZX8D)	_____	x 60 mA	_____
16-Zone expansion modules (ZX16D)	_____	x 70 mA	_____
32-Zone expansion modules (ZX32D)	_____	x 176 mA	_____
TM50	_____	x 200 mA	_____
DG457	_____	x 35 mA	_____
DG467	_____	x 35 mA	_____
Magellan wireless expansion modules (RTX3)	_____	x 35 mA	_____
4-PGM expansion modules (PGM4)	_____	x 150 mA	_____
Printer modules (PRT3)	_____	x 25 mA	_____
DVACS modules (DVAC)	_____	x 40 mA	_____
Annunciator modules (ANC1)	_____	x 20 mA	_____
InTouch voice-assisted arm/disarm modules (ADM2)	_____	x 105 mA	_____
Hub and bus isolator (HUB2)	_____	x 50 mA	_____
Hub and bus isolator (HUB4D)	_____	x 73 mA	_____
Access control module (ACM12) (The ACM12 consumes 130mA from its own power supply and cannot be powered by the Digiplex bus; the ACM11 consumes 120mA when connected to the Digiplex bus for power)	_____	x 120 mA	_____
Listen-in module (LSN4)	_____	x 60 mA	_____
Internet module (IP150)	_____	x 110 mA	_____
Plug-in voice module (VDMP3)	_____	x 35 mA	_____
Other devices such as hardwired motion detectors	_____		_____
Maximum available milliamps = 2000mA		GRAND TOTAL	_____ mA

- Using *Table 1*, calculate the total number of milliamps (mA) required by each device, module, and accessory in the system. Please take into account devices connected to the control panel's PGM outputs. Since the BELL output has its own power supply, do not include the sirens connected to it in the calculation.
- If Grand Total is less than 2000mA, go to step 3. If the value is greater, an external power supply is required (see *Figure 7* on page 10) to provide the additional power needed. Proceed with step 3 and refer to the example in *Figure 6* on page 9.
- Due to the degradation of a power signal over long distances, **EACH** length or run of wire in the system can support only a specific number of milliamps (mA). Using *Table 2*, determine how many milliamps each length of wire can support. Please note that the total number of milliamps (mA) can never surpass 2000mA.

Table 2: Milliamps (mA) Limitations For Each Run of Wire

Wire Gauge	Length (of each run of wire)	Available Milliamps (mA)	Wire Gauge	Length (of each run of wire)	Available Milliamps (mA)	Wire Gauge	Length (of each run of wire)	Available Milliamps (mA)	Wire Gauge	Length (of each run of wire)	Available Milliamps (mA)
16AWG (Surface: 1.039 sq. mm)	30 m (100 ft.)	2000	18 AWG (Surface: 0.823 sq. mm)	30 m (100 ft.)	2000	22 AWG (Surface: 0.326 sq. mm)	30 m (100 ft.)	1382	24 AWG (Surface: 0.205 sq. mm)	30m (100 ft.)	869
	61 m (200 ft.)	2000		61 m (200 ft.)	1718		61 m (200 ft.)	680		61m (200 ft.)	427
	91 m (300 ft.)	1831		91 m (300 ft.)	1151		91 m (300 ft.)	456		91m (300 ft.)	286
	122 m (400 ft.)	1366		122 m (400 ft.)	859		122 m (400 ft.)	340		122m (400 ft.)	214
	152 m (500 ft.)	1096		152 m (500 ft.)	689		152 m (500 ft.)	273		152m (500 ft.)	171
	183 m (600 ft.)	910		183 m (600 ft.)	573		183 m (600 ft.)	227		183m (600 ft.)	142
	213 m (700 ft.)	782		213 m (700 ft.)	492		213 m (700 ft.)	195			
	244 m (800 ft.)	683		244 m (800 ft.)	429		244 m (800 ft.)	170			
	274 m (900 ft.)	608		274 m (900 ft.)	382		274 m (900 ft.)	151			
	305 m (1000 ft.)	546		305 m (1000 ft.)	344		305 m (1000 ft.)	136			
	457 m (1500 ft.)	365		457 m (1500 ft.)	229						
	610 m (2000 ft.)	273		610 m (2000 ft.)	172						
	762 m (2500 ft.)	219		762 m (2500 ft.)	138						
914 m (3000 ft.)	182	914 m (3000 ft.)	115								

Figure 6: Sample Power Requirement Calculations

Power required by devices connected to control panel's auxiliary output must not exceed the auxiliary output's limit:

$$(A) + (B) + (C) + (D) + (E) + (F) + (G) = 368\text{mA} < 2000\text{mA} = \text{OK}$$

(or 1000mA if a 40VA transformer is used)

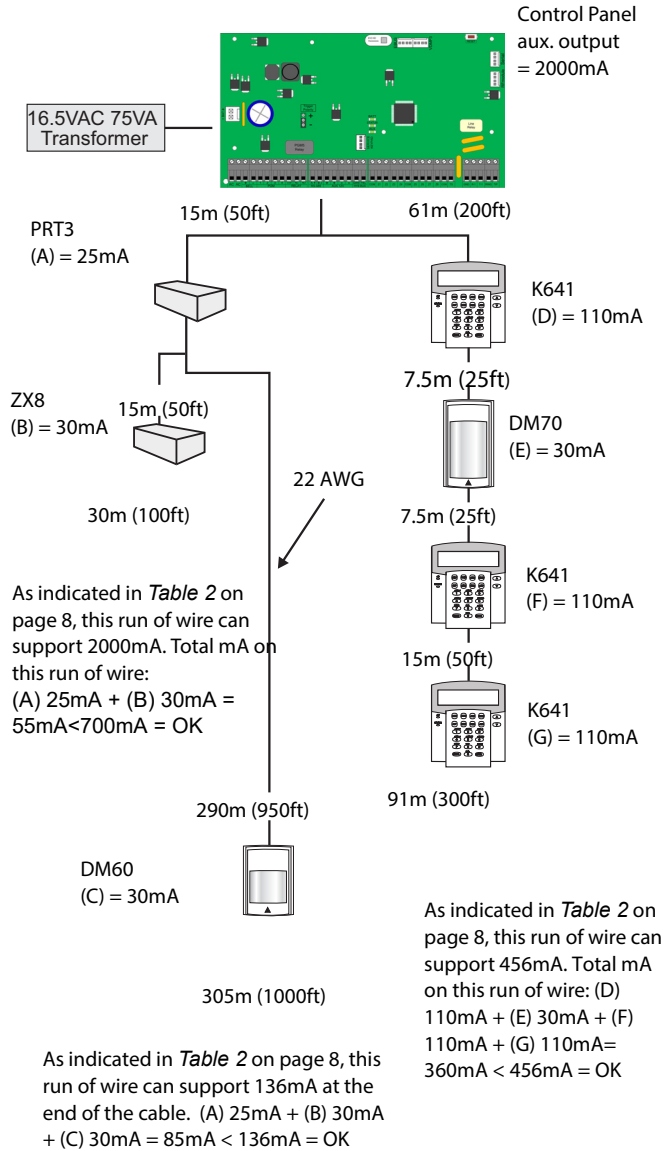

NOTE: Do not use the same transformer for the control panel and the external power supplies. Do not install modules more than 914m (3000ft) from the control panel.

Keypad Zone Connections

Every keypad has one hardwire input terminal. The keypad communicates the status of the zone to the control panel via the Digiplex bus. The detection device is connected as shown in *Figure 5* on page 6.

NOTE: Even with the ATZ feature enabled in the control panel, only one device can be connected to the keypad's hardwired input terminal. Tamper is not recognized on keypad zones. The keypad zone follows the control panel's EOL definition.

Figure 7: T External Power Supply Connections

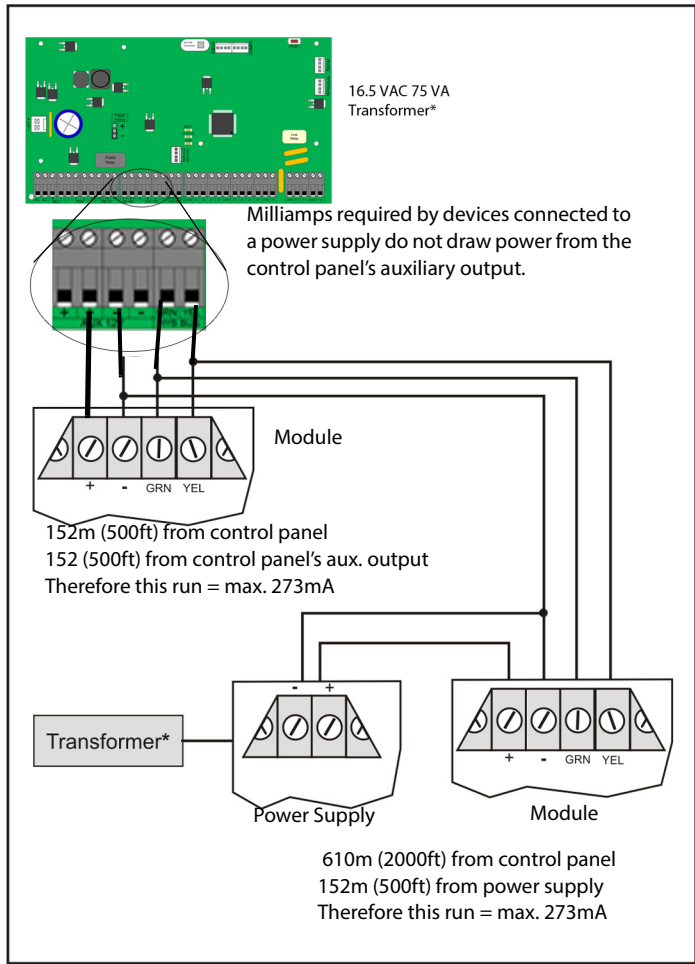

Addressable Zone Connections

The control panel includes eight hardwired input terminals for use with traditional hardwired (non-Digiplex bus) door contacts, smoke detectors and/or motion detectors.

The control panel also supports hardwire zone expansion modules. *Figure 8* shows single zone (ATZ disabled) hardwire input terminal connections recognized by the Digiplex EVOHD system. For UL listed installations, use EOL resistor part #2011002000.

Figure 8: Single Zone Input Connections

N.C. Contacts, No EOL

CONTROL PANEL TERMINAL

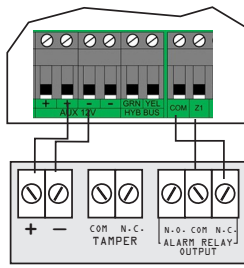

Detector Terminals



**N.O., With EOL
UI/ULC Configuration**

CONTROL PANEL TERMINAL

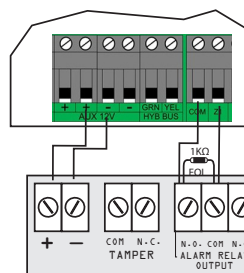

Detector Terminals **Normally Open**

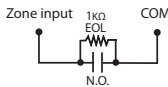

**N.C. With EOL, With Tamper & Wire Fault Recognition
UL/ULC Configuration**

CONTROL PANEL TERMINAL

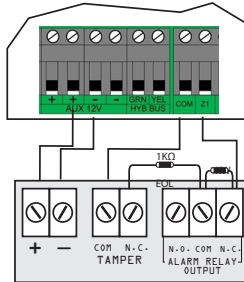

Detector Terminals

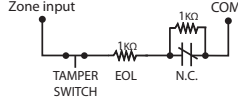

**N.C., With EOL
UI/ULC Configuration**

CONTROL PANEL TERMINAL

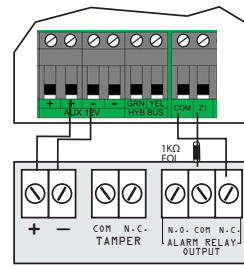

Detector Terminals **Normally Closed**

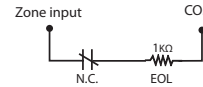

**N.C. Contacts, No EOL,
With tamper recognition**

CONTROL PANEL TERMINAL

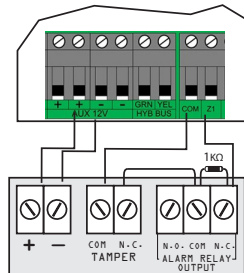

Detector Terminals

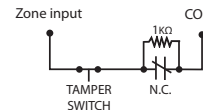

N.O., With EOL, With Tamper & Wire Fault Recognition†

CONTROL PANEL TERMINAL

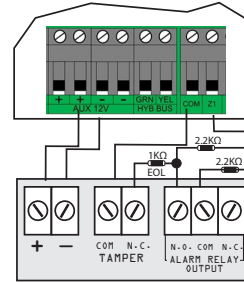

Detector Terminals

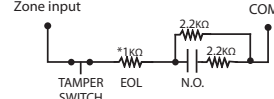

† Enable ATZ (see *section* on page 15) and connect as follows (extra input cannot be used)

* For installations without EOL, remove 1KW

Double Zone Connections

Enabling the ATZ feature allows you to install two detection devices per input terminal. Connect the devices as shown in *Figure 9*. For UL listed Burglary System installations only, use EOL resistor part #2011002000.

Figure 9: Double Zone Connections

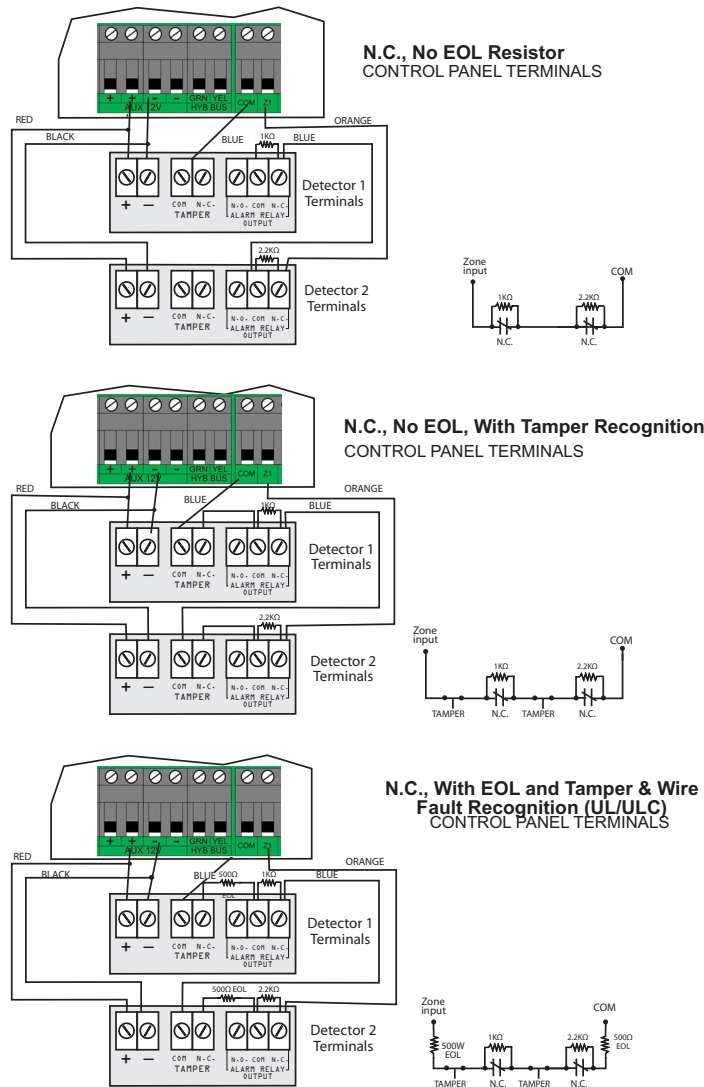

Digplex Bus Connections

The 4-wire Digplex bus can support 254 modules. Use star and/or daisy chain configuration. The total length of wire cannot exceed 914m (3000ft).

NOTE: Before connecting a module to the Digplex bus, remove AC and battery power from the control panel.

Connecting the Digplex bus in Noisy Environments

When installing the Digplex bus wires in proximity to high electrical interferences or across separate buildings, use shielded cables:

Within the Same Building: Strip the outer jacket at one end of the shielded cable to expose the shield and connect the shield to the control panel ground (not the dialer ground), while leaving the shield at the other end of the cable open (floating).

Across Separate Buildings: Strip the outer jacket at one end of the shielded cable to expose the shield. In the same building as the control panel, connect the exposed shield to any earth ground available, while leaving the shield at the other end of the cable open (floating). The same configuration applies for any subsequent building.

Fire Circuits

Assign the smoke detectors connected to the control panel or zone expansion input terminals to a zone and define the zone's parameters as a Fire Zone (see *section* and *section* on page 16).

Smoke Detector Installation (2-Wire)*

PGM1 can be defined as a 2-wire smoke detector input (see *page 35*). Connect the 2-wire smoke detectors as shown in *Figure 10*. If a line short occurs or the smoke detector activates, whether the system is armed or disarmed, the control panel will generate an alarm. If the line is open, the "Zone Fault" trouble indication appears in the Trouble Display and the report code is sent to the monitoring station, if programmed.

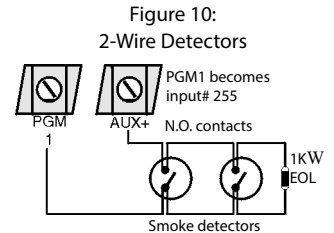

Note: It is recommended that the smoke detectors be connected in a daisy chain configuration.

***UL Note:** Not to be used with UL Listed systems.

ESL CleanMe® Installation

Connect ESL smoke detectors like the standard smoke detectors. Avoid connecting more than 20 ESL smoke detectors. When a CleanMe signal is sent, the control panel will generate a Zone Fault trouble and may transmit the Fire Loop report code to the monitoring station. The trouble will be cleared if there is no CleanMe signal for 255 seconds. If an alarm occurs, the trouble will be cleared until it is detected again.

Smoke Detector Installation (4-Wire)

Recommended: System Sensor model 2112/24D smoke detectors. Connect the 4-wire smoke detectors and a relay as shown in *Figure 11*. To comply with UL955, install the 4-wire smoke detectors with 18 gauge wire. If power is interrupted, the relay causes the control panel to transmit the Fire Loop Trouble report programmed in *section [2906]*.

To reset (unlatch), connect the smoke detector's negative (-) to a PGM. Then program the PGM with the "Smoke Detector Power Reset" activation event (see *section* on page 35; Event Group #067, start # 004, end # 004) to interrupt power to the smoke detector for four seconds when the [CLEAR] and [ENTER] keys are pressed and held for two seconds.

Figure 11: 4-Wire Detectors

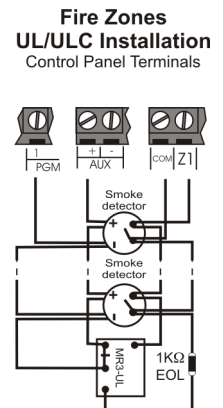

Note: It is recommended that the smoke detectors be connected in a daisy chain configuration.

NOTE: If ATZ is enabled (see *section* on page 15), do not use the extra input (doubled zone).

Figure 12: Telephone Line Connection Examples

Example 1:

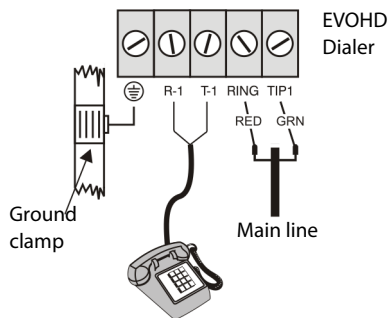

Example 2:

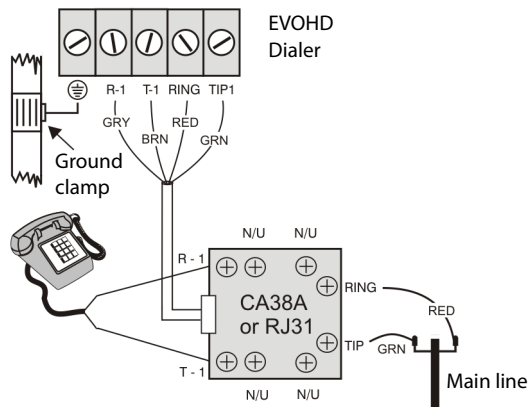

Telephone Line Connections

The telephone lines can be connected directly to the control panel or through a CA38A or RJ31 as shown in *Figure 12*.

UL Note: *Installer must verify line seizure after every installation*

For TBR-21 compliance, please note the following:

1. The EVOHD can be connected to the telephone network via an RJ-11 connector.
2. The Maximum Dialing Attempts cannot exceed 15 attempts (page 31).

Programming Methods

BabyWare Uploading/Downloading Software*

We recommend programming the control panel with BabyWare. Refer to *BabyWare Software* on page 44 for details.

* **UL Note:** Not verified by UL

Module Broadcast

Keypads and other modules can also be programmed easily by using Module Broadcast. Once a module is programmed, its sections can be sent to other similar modules through the Digiplex bus.

Programming Through a Keypad

Use the “*EVOHD Programming Guide*” to record how the sections were programmed. To enter programming mode:

Table 3:

-
1. Press and hold the **[0]** key.
 2. Key in the **[INSTALLER CODE]** (default = **000000**).
 3. Key in the 4-digit **[SECTION]**.
 4. Key in required **[DATA]**. Refer to the “*EVOHD Programming Guide*” or to the corresponding sections in this manual.
-

For LCD Keypads: The control panel will save the data and go to the next section or press the **[ENTER]** key to save the data and go to the next section. Press the **[CLEAR]** key go to the preceding step or to erase the current data entry.

Feature Select Programming

Most of the options are programmed using the Feature Select Method.

For LCD Keypads: The option is considered ON when the number appears within the brackets on the LCD keypad. Turn options ON and OFF by pressing the corresponding keys on the keypad and then press **[ENTER]** to save.

Decimal Programming

Sections may require 3-digit decimal values from 000 to 255.

Hexadecimal Programming

Sections may require Hexadecimal values from 0 to F. Press:

For LCD Keypads:

[0] to [9]	= values 0 to 9 respectively		
[STAY] key	= A	[DISARM] key	= D
[FORCE] key	= B	[BYP] key	= E
[ARM] key	= C	[MEM] key	= F

Module Programming Mode

To program a Module with a keypad, enter Module Programming Mode:

Table 4:

-
1. Press and hold the **[0]** key.
 2. Key in the **[INSTALLER CODE]** (default = **000000**).
 3. Key in section **[4003]**.
 4. Key in 8-digit **[SERIAL NUMBER]** of the module.
 5. Key in 3-digit **[SECTION]** and required **[DATA]**. Refer to the “*Module Programming Guide*” for details.
-

The control panel will redirect all programming to the selected module. To exit the Module Programming Mode, press the **[CLEAR]** key on LCD keypads.

Zone Programming

Enter Section [0400], then enter the number of the zone you want to program

! In any Zone Programming option, pressing [ACC] will save the data and go to the next zone on the same option screen. Pressing [TRBL] will save the data and go to the previous zone on the same option screen.

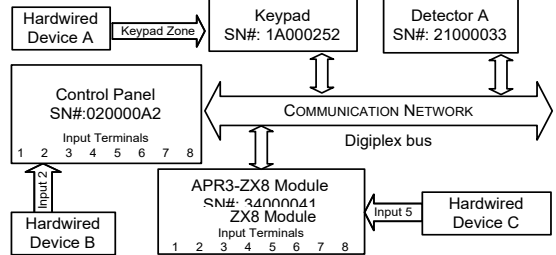

	Zone#	Section#	Serial#	Input#
Detector A:	1 =	[0001]	21000033	N/A
Hardwired Device A:	2 =	[0002]	1A000252	N/A
Hardwired Device B:	3 =	[0003]	020000A2	002
Hardwired Device C:	4 =	[0004]	34000041	005

Enter the zone's 8-digit serial and 3-digit input number (The input number is not needed for module with only one input)

Enter the zone's parameters (01) (*2*****) default

Zone Definitions	
Input Value	Description
0	Disabled (default)
1	Entry delay 1
2	Entry delay 2
3	Follow
4	Instant
5	24 hr. buzzer
6	24 hr. burglary
7	24 hr. hold-up
8	24 hr. gas
9	24 hr. heat
A	24 hr. water
B	24 hr. freeze
C	Delayed 24 hr. fire
D	Standard 24 hr. fire
E	Stay delay 1
F	Stay delay 2/Anti-mask

Partition Assignment	
Input Value	Description
1	Assign to partition 1
2	Assign to partition 2
3	Assign to partition 3
4	Assign to partition 4
5	Assign to partition 5
6	Assign to partition 6
7	Assign to partition 7
8	Assign to partition 8

Zone Options	
Input Value(s)	Description
1	Auto zone shutdown enabled
2	Bypass enabled (default: ON)
3	Stay zone
4	Force zone (default: ON)
5 OFF 6 OFF	(Zone Alarm) Steady alarm
5 OFF 6 ON	(Zone Alarm) Pulsed alarm
5 ON 6 OFF	(Zone Alarm) Silent alarm
5 ON 6 ON	(Zone Alarm) Report only
7	Intellizone
8	Delay before transmission

Enter the zone extended options (1**4****)

Zone Extended Options				
Option	Description		ON	
1	Zone tamper (follow global settings in section [3034] option 5 & 6)	<input type="checkbox"/>	Disabled	<input type="checkbox"/> Enabled
2 & 3	Zone tamper supervision	-	See Zone Tamper	See Zone Tamper
4	Anti-mask trouble (follow global settings in section [3029] option 5 & 6)	<input type="checkbox"/>	Disabled	<input type="checkbox"/> Enabled
5 & 6	Anti-mask supervision	<input type="checkbox"/>	See anti-mask Sup. Options	See anti-mask Sup. Options
7	Future use	<input type="checkbox"/>	-	-
8	Future use	<input type="checkbox"/>	-	-

Zone Tamper Options			
Option	2	3	Description
OFF	OFF	OFF	Disabled (default)
OFF	ON	OFF	Generates trouble only (when armed or disarmed)
ON	OFF	OFF	When armed: alarm When disarmed: generates trouble only
ON	ON	OFF	When armed: alarm When disarmed: generates audible alarm

Enter the zone's report codes (00) (00) (00) (00) default

Anti-mask Supervision Options			
Option	2	3	Description
OFF	OFF	OFF	Disabled (default)
OFF	ON	OFF	Generates trouble only (when armed or disarmed)
ON	OFF	OFF	When armed: alarm When disarmed: generates trouble only
ON	ON	OFF	When armed: alarm When disarmed: generates audible alarm

Enter the zone's label

Press [ENTER] to save and go to the next zone

Pressing [CLEAR] twice will exit the zone programming menus. Press [ENTER] before pressing clear to save your modifications.

Alarm Report Code	Alarm Restore Report Code	Tamper Report Code	Tamper Restore Report Code
__	__	__	__

Ademco slow, Silent Knight fast, SESCOA, Ademco express or Pager formats:
Key-in desired 2-digit hex values from 00 to FF.

Ademco format:
Use section [4032] to program a set of default Ademco report codes from the *Auto Report Code Programming* on page 32. Then to program the remaining report codes or to change some of the defaults, enter the individual sections and key-in the desired 2-digit hex value found in the *Appendix 2: Contact ID Report Code List* on page 49.

SIA format:
Use section [4032] to program a set of SIA report codes from the *Auto Report Code Programming* on page 32. Codes that have not been set to default can be set to default manually by entering FF in the appropriate section. To disable the reporting of an event, enter 00 in the appropriate section.

Zone Programming

Two different methods can be used to program zones:

Using section [0400]

Allows you to program zones 001 through 192 as shown in the diagram on page 14.

NOTE: In any Zone Programming option, pressing [ACC] will save the data and go to the next zone on the same option screen. Pressing [TRBL] will save the data and go to the previous zone on the same option screen.

Using zone serial and input numbers

If you are not using an K641, K641R or K641+ keypad, you can only program zones 1 to 96 through sections [0001] to [0096]. Zone extended options are not programmable.

Zone Number	Zone Numbering	Zone Definitions	Report Codes	Label
1	[0001]	[0101]	[0201]	[0301]
2	[0002]	[0102]	[0202]	[0302]
	+1 per zone	+1 per zone	+1 per zone	+1 per zone
96	[0096]	[0196]	[0296]	[0396]

Zone Numbering

VHFWIRQ ^3733`
VHFWIRQV ^3334`WR ^33<9`

- To assign an addressable PIR or door contact to the Digiplex bus, program the module's serial number into the section corresponding to the zone.
- To assign a detection device connected to a module or control panel's hardwired input terminal, program the module's or control panel's serial number and the input number to the desired zone. See the "Digiplex Modules Programming Guide" for details of its input numbers (input numbers not required for keypad zones).

NOTE: If PGM1 is defined as a smoke detector input (see *section* on page 35), the control panel will recognize it as input # 255.

Clearing a Zone's Numbering

Using section [0400]

- Enter the zone number you wish to delete.
- Press [0] all the way through the serial/input, parameters and report codes screen.
- Press [ENTER] to exit.

Using an LCD Keypad:

- Enter a section number between [0001] to [0096].
- Press [0] and then [ENTER] to save and exit.

Zone Doubling (ATZ)

VHFWIRQ ^6366`=RSWIRQ ^;`
(default = **disabled**) Fire Zones cannot be doubled.

Input	Doubled Zone Input
Input 01	Input 09 (ATZ of Input 01)
Input 02	Input 10 (ATZ of Input 02)
Input 03	Input 11 (ATZ of Input 03)
Input 04	Input 12 (ATZ of Input 04)
Input 05	Input 13 (ATZ of Input 05)
Input 06	Input 14 (ATZ of Input 06)
Input 07	Input 15 (ATZ of Input 07)
Input 08	Input 16 (ATZ of Input 08)

Zone Definitions

Zone Disabled

section [0400]: First digit = 0
VHFWIRQV ^3434`WR ^34<9`=IUVVW GLJW @ 3
Disables the corresponding zone. Zones are disabled by default.

Entry Delays 1 and 2

section [0400]: First digit = 1 and 2
VHFWIRQV ^3434`WR ^34<9`=IUVVW GLJW @ 4 DQG 5
(default Entry Delay 1 = **030**, Entry Delay 2 = **060**) A zone defined as Entry Delay 1 follows the Entry Delay 1 Timer of its assigned partition. A zone defined as Entry Delay 2 follows the Entry Delay 2 Timer of its assigned partition. Each partition includes two Entry Delay Timers. To program an Entry Delay Timer, key in the desired 3-digit delay value (001 to 255 seconds) into the corresponding section.

Partition 1 Entry Delay 1 Timer: [3111] Entry Delay 2 Timer: [3112]	Partition 2 Entry Delay 1 Timer: [3211] Entry Delay 2 Timer: [3212]
Partition 3 Entry Delay 1 Timer: [3311] Entry Delay 2 Timer: [3312]	Partition 4 Entry Delay 1 Timer: [3411] Entry Delay 2 Timer: [3412]
Partition 5 Entry Delay 1 Timer: [3511] Entry Delay 2 Timer: [3512]	Partition 6 Entry Delay 1 Timer: [3611] Entry Delay 2 Timer: [3612]
Partition 7 Entry Delay 1 Timer: [3711] Entry Delay 2 Timer: [3712]	Partition 8 Entry Delay 1 Timer: [3811] Entry Delay 2 Timer: [3812]

NOTE: These are the same timers used for Stay Delay zones.

Follow Zones

section [0400]: First digit = 3
VHFWIRQV ^3434`WR ^34<9`=IUVVW GLJW @ 6
The control panel waits until the end of the Entry Delay before generating an alarm if an Entry Delay zone opens before the Follow zone.

Instant Zones

VHFWIRQ ^3733`=IUVVW GLJW @ 7
VHFWIRQV ^3434`WR ^34<9`=IUVVW GLJW @ 7
When an armed Instant zone opens, the control panel immediately generates an alarm.

24Hr Buzzer Zones

VHFWIRQ ^3733`=IUVVW GLJW @ 8
VHFWIRQV ^3434`WR ^34<9`=IUVVW GLJW @ 8
Whenever a 24Hr Buzzer zone opens, the control panel activates the keypad buzzer to indicate that the zone was breached. The control panel will report the alarm, but will not enable the bell/siren output. Enter any valid access code on the keypad to stop the buzzer.

NOTE: The keypads must be assigned to the same partition as the 24Hr Buzzer zone or the buzzer will not activate. UL Note: Not to be used for perimeter protection.

24Hr Burglary Zones

VHFWIRQ ^3733`=IUVVW GLJW @ 9
VHFWIRQV ^3434`WR ^34<9`=IUVVW GLJW @ 9
When a 24Hr Burglary zone opens, the control panel will immediately generate a burglary alarm.

24Hr Hold-up Zones

VHFWIRQ ^3733`=IUVVW GLJW @ :
VHFWIRQV ^3434`WR ^34<9`=IUVVW GLJW @ :
When a 24Hr Hold-up zone opens, the control panel will immediately generate an alarm.

NOTE: The SIA FSK reporting format includes specific codes to identify the alarm as a Hold-up, Gas, Heat, Water, or Freeze Alarm.

24Hr Gas Zones*

VHFWIRQ ^3733 '=IUVV GLJW @ ;

VHFWIRQV ^3434 'WR ^34<9 '=IUVV GLJW @ ;

When a 24Hr Gas zone opens, the control panel will immediately generate an alarm.

24Hr Heat Zones**

VHFWIRQ ^3733 '=IUVV GLJW @ <

VHFWIRQV ^3434 'WR ^34<9 '=IUVV GLJW @ <

When a 24Hr Heat zone opens, the control panel will immediately generate an alarm.

**** UL Note:** UL Listed compatible devices must be used for UL systems. For UL Listed systems, this type of zone should be programmed as a pulsing Fire alarm.

24Hr Water Zones*

VHFWIRQ ^3733 '=IUVV GLJW @ D

VHFWIRQV ^3434 'WR ^34<9 '=IUVV GLJW @ D

When a 24Hr Water zone opens, the control panel will immediately generate an alarm.

24Hr Freeze Zones*

VHFWIRQ ^3733 '=IUVV GLJW @ E

VHFWIRQV ^3434 'WR ^34<9 '=IUVV GLJW @ E

When a 24Hr Freeze zone opens, the control panel will immediately generate an alarm.

*** UL Note:** UL Listed compatible devices must be used for UL systems. For UL Listed systems, this type of zone must be programmed as a silent auxiliary alarm.

Delayed 24Hr Fire Zone (Not to be used with UL Listed systems)

VHFWIRQ ^3733 '=IUVV GLJW @ F

VHFWIRQV ^3434 'WR ^34<9 '=IUVV GLJW @ F

The Delayed 24Hr Fire Zone definition from *Figure 14* on page 17 is used in homes where a smoke detector often generates false alarms. A zone programmed as Fire becomes normally open and requires an EOL resistor.

 **The keypads must be assigned to the same partition as the Delayed 24Hr Fire zone for the buzzer to activate.**

*** UL Warning:** For UL/ULC installations, a Fire zone cannot be bypassed and its alarm type must be Pulsed (audible).

Standard 24Hr Fire Zone

VHFWIRQ ^3733 '=IUVV GLJW @ G

VHFWIRQV ^3434 'WR ^34<9 '=IUVV GLJW @ G

A zone programmed as Fire becomes normally open and requires an EOL resistor. When a Standard 24Hr Fire Zone triggers, the control panel can:

- ◆ send a Zone Alarm report code page 28.
- ◆ send a Fire Loop Trouble Report (page 29) if a tamper/wiring fault occurs on a Fire Zone. A "Zone Fault Trouble" will also appear in the keypad's Trouble Display.
- ◆ generate a Fire alarm, which can be silent, pulsed, steady or report only. Fire alarms generate an intermittent signal (see *Figure 13*).

*** UL Warning:** For UL/ULC installations, a Fire Zone cannot be bypassed and its alarm type must be Pulsed (audible).

Figure 13: Bell/Siren Output During Fire Alarm

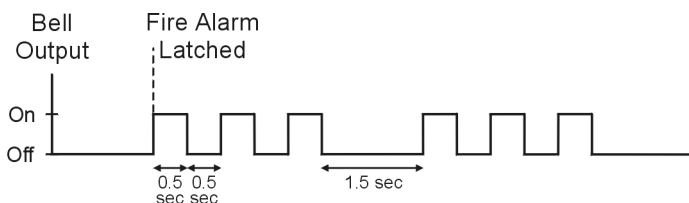

Stay Delay Zone

VHFWIRQ ^3733 '=IUVV GLJW @ H D Q G I

VHFWIRQV ^3434 'WR ^34<9 '=IUVV GLJW @ H D Q G I

Using the Regular or Force arming methods, the control panel processes the zone as an Instant zone. Using the Stay or Instant arming methods and the zone is triggered, the control panel will not generate an alarm until the programmed Stay Delay elapses. A zone defined as Stay Delay 1 follows the Entry Delay 1 Timer of its assigned partition. A zone defined as Stay Delay 2 follows the Entry Delay 2. To program the Entry Delay Timers, refer to *Entry Delays 1 and 2* on page 15.

Zone Partition Assignment

VHFWIRQ ^3733 '=VHFRQG GLJW @ 4 WR ;

VHFWIRQV ^3434 'WR ^34<9 '=VHFRQG GLJW @ 4 WR ;

Assign zones to one partition.

Zone Options

The zone options from are described below. Refer to the EVOHD programming guide for additional information on Zone Programming.

Auto Zone Shutdown

VHFWIRQ ^3733 '=RSWIRQ ^4 '

VHFWIRQV ^3434 'WR ^34<9 '=RSWIRQ ^4 '

(default = 000) When enabled, the control panel will stop generating alarms once the Auto Zone Shutdown Limit is reached. It resets every time the partition that is assigned to the corresponding zone is armed. To program the Auto Zone Shutdown Limit, enter the desired 3-digit counter (000 to 015) into section corresponding to the desired partition (000 = disabled):

Partition 1: [3114]	Partition 5: [3514]
Partition 2: [3214]	Partition 6: [3614]
Partition 3: [3314]	Partition 7: [3714]
Partition 4: [3414]	Partition 8: [3814]

Bypass Zones

VHFWIRQ ^3733 '=RSWIRQ ^5 '

VHFWIRQV ^3434 'WR ^34<9 '=RSWIRQ ^5 '

(default = enabled) Allow zones to be Manually Bypassed.

Stay Zones

VHFWIRQ ^3733 '=RSWIRQ ^6 '

VHFWIRQV ^3434 'WR ^34<9 '=RSWIRQ ^6 '

Only zones with option **[3]** enabled will be bypassed when the partition is Stay armed or Instant armed. All other zones will remain activated. Fire Zones cannot be set as Stay Zones.

Force Zones (Not to be used with UL Listed systems)

VHFWIRQ ^3733 '=RSWIRQ ^7 '

VHFWIRQV ^3434 'WR ^34<9 '=RSWIRQ ^7 '

Only zones with option **[4]** enabled can be bypassed when the partition is Force armed. Fire Zones cannot be Force Zones.

Alarm Types

VHFWIRQ ^3733 '=RSWIRQ ^5') ^9'

VHFWIRQV ^3434 'WR ^34<9 '=RSWIRQV ^8') ^9'

Option	Feature	Description
[5]	[6]	
OFF	OFF	Steady Alarm sends the report code and activates the bell output
ON	OFF	Pulsed Alarm sends the report code and pulses the bell output (see Figure 14)
OFF	ON	Silent Alarm sends the report code, but the bell output is not activated. Partition must be disarmed.
ON	ON	Report Only sends the report code. Disarming is not required.

Intellizone*

VHFWIRQ ^3733 '=RSWIRQ ^: '

VHFWIRQV ^3434 'WR ^34<9 '=RSWIRQ ^: '

(default = **032**) If an alarm condition occurs on a zone with option **[7]** enabled, the control panel triggers the Intellizone Delay. Fire Zones cannot be set as Intellizones. An alarm will only be generated if the selected conditions occur during the Intellizone Delay:

1. An alarm occurs on another zone defined as Intellizone.
2. The zone in alarm restores and reoccurs.
3. The zone stays in alarm for the entire Intellizone Delay.

Key in the desired 3-digit delay value (010 to 255 seconds, default value is 32 seconds) into the section corresponding to the desired partition

NOTE: Any value less than 10 seconds will be replaced by the default value of 32 seconds.

Partition 1: [3110]	Partition 3: [3310]	Partition 5: [3510]	Partition 7: [3710]
Partition 2: [3210]	Partition 4: [3410]	Partition 6: [3610]	Partition 8: [3810]

*UL Note: For UL Listed systems, the detection pattern of both zones must be installed so that each zone has the capability of protecting the area alone.

Intellizone Options

Use these options to enable or disable different Intellizone related options.

Partition 1: [3126]	Partition 3: [3326]	Partition 5: [3526]	Partition 7: [3726]
Partition 2: [3226]	Partition 4: [3426]	Partition 6: [3626]	Partition 8: [3826]

Option	Description
[1]	Intellizone Delay (default = disabled) The zone stays in alarm for the entire Intellizone Delay.
[2]	Intellizone Double Knockout and Zone Crossing (default = disabled) The zone in alarm restores and reoccurs or an alarm occurs on another zone defined as Intellizone
[3]	Intellizone Zone Crossing (default = disabled) An alarm occurs on another zone defined as Intellizone.
[5]	Police Code is Generated on Zone Crossing Only (default = disabled)

Figure 14: Delayed 24Hr Fire Zone

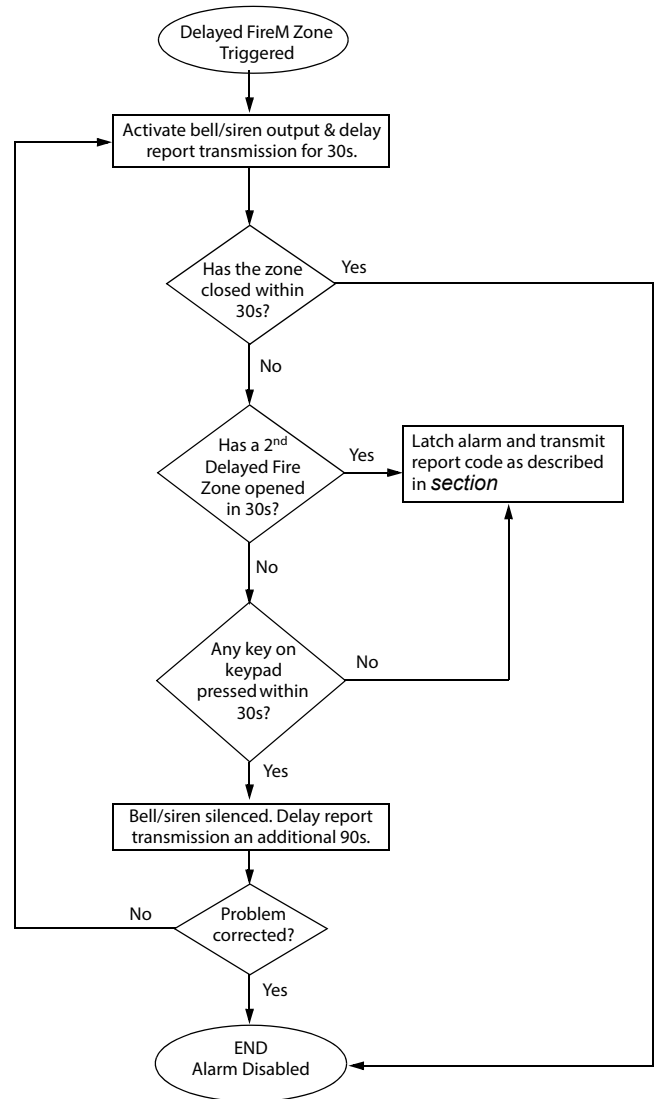

Delay Before Alarm Transmission

VHFWIRQ ^3733 '=RSWIRQ ^; '

VHFWIRQV ^3434 'WR ^34<9 '=RSWIRQ ^; '

(default = **000**) When an alarm condition occurs on a zone with option **[8]** enabled, the alarm will not be reported to the monitoring station until the end of the Alarm Transmission Delay. Disarming the system cancels any report originating from this zone. To program the Alarm Transmission Delay, access section **[3055]**.

Input Speed

(001 to 255 X 30msec, default = **600ms**)

The Input Speed defines how quickly the control panel responds to an open zone detected on any hardwired input terminal (does not apply to addressable motion detectors and door contacts). Set the Input Speed (001 to 255 X 30ms, default = **600ms**):

[0961]	Input 01	[0973]	Input 13 (ATZ of Input 01)
[0962]	Input 02	[0974]	Input 14 (ATZ of Input 02)
[0963]	Input 03	[0975]	Input 15 (ATZ of Input 03)
[0964]	Input 04	[0976]	Input 16 (ATZ of Input 04)
[0965]	Input 05	[0977]	Input 13 (ATZ of Input 01)
[0966]	Input 06	[0978]	Input 14 (ATZ of Input 02)
[0967]	Input 07	[0979]	Input 15 (ATZ of Input 03)
[0968]	Input 08	[0980]	Input 16 (ATZ of Input 04)

EOL on Hardwire Zones

VHFWIRQ ^6366 '=RSWIRQ ^: '

(default = **disabled**) If detection devices connected to hardwired input terminals use 1k Ω end of line resistors, enable option **[7]** in section **[3033]**. For details on using EOL resistors, refer to *Addressable Zone Connections* on page 10 and *Double Zone Connections* on page 11. For more information on EOL options, please refer to the EVOHD programming guide.

Selectable Input Resistor

VHFWIRQ ^3735 '

(default = **disabled**) To select a different value for EOL resistor, please refer to the EVOHD Programming Guide.

Keypad Numbering

VHFWIRQV ^5;34 \WR ^5;65 '

Keypad Numbering identifies the keypad in the event buffer. The keypad is assigned to a Keypad Number from 1 to 32 through the keypad's serial number in sections **[2801]** to **[2832]**.

Remote Control Programming

Hardware Requirements

If the EVOHD System Includes:

RTX3 Wireless Expansion Module And K641 / K641R / K641+ keypad
 Up to 999 remote controls can now be programmed into the EVOHD control panel and configured using a master code or installer code.

If the System Includes:

RTX3 Wireless Expansion Module But does not include K641 / K641R / K641+ keypad. Remote controls must be stored in the wireless expansion module (32 remotes per RTX3) by enabling option [1] in section [3029].

Remote Control Template

It is possible to set up to 16 different button templates which can then be assigned to individual users. Each user is pre-programmed with a default remote control button pattern: (1 B) (C 0) (template 0).

NOTE: NOTE: Button definitions and partition / one-touch definitions are linked together to create a button template. For example, Template 0 is comprised of button definition [2900] together with partition / one-touch definition [2916].

Remote Control Templates

To use REM3 templates:

- 1: Define the 16 button definitions in sections [2900] to [2915].
- 2: Define the 16 partition / one-touch definitions in sections [2916] to [2931].
- 3: Define which button template is used as the default template for remotes in section [2940].
- 4: Assign button templates to users in section [2941]

Entering Data:



	PGM Keys								Partitions**		One-Touch	
	PGM1 [9]	PGM2 [0]	PGM3 [x]	PGM4 [✓]	PGM5 [●]	PGM6 [●]	PGM3&4 [x] + [✓]	PGM5&6 [●] + [●]			One-touch PGM Keys	One-touch Disarm Keys
Default data:	1*	B*	C*	0*	5	6	0	0	Default = 0 (all user's partitions)	Default = F (no partitions)	△ = Disabled (default) □ = Enabled	
Templates												
0 [2900]	___	___	___	___	___	___	___	___	[2916]	___	<input type="checkbox"/>	<input type="checkbox"/>
1 [2901]	___	___	___	___	___	___	___	___	[2917]	___	<input type="checkbox"/>	<input type="checkbox"/>
2 [2902]	___	___	___	___	___	___	___	___	[2918]	___	<input type="checkbox"/>	<input type="checkbox"/>
3 [2903]	___	___	___	___	___	___	___	___	[2919]	___	<input type="checkbox"/>	<input type="checkbox"/>
4 [2904]	___	___	___	___	___	___	___	___	[2920]	___	<input type="checkbox"/>	<input type="checkbox"/>
5 [2905]	___	___	___	___	___	___	___	___	[2921]	___	<input type="checkbox"/>	<input type="checkbox"/>
6 [2906]	___	___	___	___	___	___	___	___	[2922]	___	<input type="checkbox"/>	<input type="checkbox"/>
7 [2907]	___	___	___	___	___	___	___	___	[2923]	___	<input type="checkbox"/>	<input type="checkbox"/>
8 [2908]	___	___	___	___	___	___	___	___	[2924]	___	<input type="checkbox"/>	<input type="checkbox"/>
9 [2909]	___	___	___	___	___	___	___	___	[2925]	___	<input type="checkbox"/>	<input type="checkbox"/>
10 [2910]	___	___	___	___	___	___	___	___	[2926]	___	<input type="checkbox"/>	<input type="checkbox"/>
11 [2911]	___	___	___	___	___	___	___	___	[2927]	___	<input type="checkbox"/>	<input type="checkbox"/>
12 [2912]	___	___	___	___	___	___	___	___	[2928]	___	<input type="checkbox"/>	<input type="checkbox"/>
13 [2913]	___	___	___	___	___	___	___	___	[2929]	___	<input type="checkbox"/>	<input type="checkbox"/>
14 [2914]	___	___	___	___	___	___	___	___	[2930]	___	<input type="checkbox"/>	<input type="checkbox"/>
15 [2915]	___	___	___	___	___	___	___	___	[2931]	___	<input type="checkbox"/>	<input type="checkbox"/>

*REM1/RAC1 and REM2/RAC2 remotes only use the data in these columns.

** If "0" is entered, the associated buttons will control all partitions to which the user is assigned. If "F" is entered, the associated buttons will be disabled

Template Data

Entry		Function
K641/K641R/ K641LX	K656	
[0]	[0]	Button Disabled
[1]	[1]	Regular Arm
[2]	[2]	Stay Arm
[3]	[3]	Instant Arm
[4]	[4]	Force Arm
[5]	[5]	Utility Key 5
[6]	[6]	Utility Key 6
[7]	[7]	N/A
[8]	[8]	Panic 1
[9]	[9]	Panic 2
A = [stay]	A = [ARM]	Panic 3
B = [force]	B = [SLEEP]	Utility Key 1
C = [ARM]	C = [STAY]	Utility Key 2
D = [DISARM]	D = [OFF]	Utility Key 3
E = [BYP]	E = [MENU]	Utility Key 4
F = [MEM]	F = []	N/A

Section	Description
[2940] Default Button Template	To select a button template as the default template, enter (00) to (15) representing button templates in sections [2900] to [2915] .
[2941] Assign Button Template	To assign a button template to a user, select user when prompted, then enter (00) to (15) representing button templates in sections [2900] to [2915] . If user 000 is selected, all users are modified.

Keyswitch Programming

Keyswitch Numbering

VHFWIRQV ^3834 `WR ^3865 `

Keyswitch Numbering allows you to assign any hardwired input in the system to any of the 32 keyswitch zones in the control panel (see *Figure 15*). **UL Note:** Do not use Keyswitches in UL Listed systems.

Figure 15: Example of Keyswitch Numbering

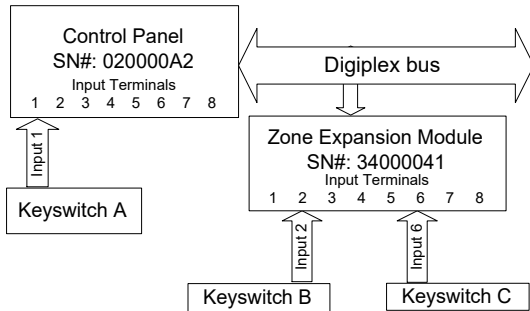

Keyswitch	Zone #	Section	Serial#	Input#
Keyswitch A:	1 =	[0501]	020000A2	001
Keyswitch B:	2 =	[0502]	34000041	002
Keyswitch C:	3 =	[0503]	34000041	006

Keyswitch Definitions

Keyswitch Definitions determine how a keyswitch is used.

Keyswitch Disabled

VHFWIRQV ^3934 `WR ^3965 `=IUVVW GLJW @ 3

Disables keyswitch input.

Momentary Keyswitch

VHFWIRQV ^3934 `WR ^3965 `=IUVVW GLJW @ 4

To arm or disarm a partition using the Momentary Keyswitch, turn on the keyswitch for three seconds then turn it off.

Maintained Keyswitch

VHFWIRQV ^3934 `WR ^3965 `=IUVVW GLJW @ 5

To arm a partition using the Maintained Keyswitch, turn the switch from the ON to the OFF position. Disarm it by setting the key on the ON position.

Generates a Utility Key Event on Open

VHFWIRQV ^3934 `WR ^3965 `=IUVVW GLJW @ 6

To program a keyswitch to generate a Utility Key Event:

1. Program the Activation Event of a PGM output with the *Utility Key Event* corresponding to the desired keyswitch (see *PGM Programming Table* in the "EVOHD Programming Guide": Event Group 048).
2. Enable option [3] in the section corresponding to the desired keyswitch.

Generates a Utility Key Event on Open and Close

VHFWIRQV ^3934 `WR ^3965 `=IUVVW GLJW @ 7

A Utility Key Event can be generated whenever the keyswitch input is opened or closed. The Utility Key Events increase from 32 to 64 events; one event for each state.

When a keyswitch is defined with the Generate a Utility Key Event on Open and Close option, the Keyswitch Partition Assignment and Keyswitch Options are disabled. To program a keyswitch to generate a Utility Key Event:

1. Program the Activation Event of a PGM output with the *Utility Key Event* corresponding to the desired keyswitch (see *PGM Programming Table* in the "EVOHD Programming Guide": Event Group 048).
2. Enable option [4] in the section corresponding to the desired keyswitch.

Keyswitch Partition Assignment

VHFWIRQV ^3934 `WR ^3965 `=VHFRQG GLJW @ 4 WR ;

Each keyswitch must be assigned to one partition.

Keyswitch Options

Each keyswitch zone can be programmed with one or more options.

Disarm Only

Sections [0601] to [0632]: Option [3]

When enabled, the keyswitch can only disarm assigned partitions. The type of disarming is determined by the other Keyswitch Options selected.

Stay/Instant Disarm Option (Keyswitch)

VHFWIRQV ^3934 `WR ^3965 `=RSWIRQ ^7 `

When enabled, the keyswitch can only disarm assigned Stay or Instant armed partitions. When option [4] is disabled, the keyswitch can disarm partitions armed using any arming method.

Arm Only (Keyswitch)

VHFWIRQV ^3934 `WR ^3965 `=RSWIRQ ^8 `

When enabled, the keyswitch can only arm assigned partitions. The type of arming is determined by the other Keyswitch Options selected.

Regular Arming (Keyswitch)

VHFWIRQV ^3934 `WR ^3965 `=RSWIRQ ^9 `WR ^; `

With disabled, the arming option will be Regular arming.

Stay Arming (Keyswitch)

VHFWIRQV ^3934 `WR ^3965 `=RSWIRQ ^9 `

Activating the keyswitch will Stay Arm the partition.

Force Arming (Keyswitch)

VHFWIRQV ^3934 `WR ^3965 `=RSWIRQ ^: `

Activating the keyswitch will force arm the selected partition.

Instant Arming (Keyswitch)

VHFWIRQV ^3934 `WR ^3965 `=RSWIRQ ^; `

This option is identical to Stay arming except that all armed zones will become Instant Zones page 15.

NOTE: Only one of the arming options (Stay, Force, Instant and Regular) can be selected.

Arming and Disarming Options

Arming Follows Partition

(default = **disabled**) A partition can be set to follow the arming and disarming status of one or more partitions.

Section:	Partition arms & disarms with:
Partition 1: [3121]	Option [1] = Partition 1
Partition 2: [3221]	Option [2] = Partition 2
Partition 3: [3321]	Option [3] = Partition 3
Partition 4: [3421]	Option [4] = Partition 4
Partition 5: [3521]	Option [5] = Partition 5
Partition 6: [3621]	Option [6] = Partition 6
Partition 7: [3721]	Option [7] = Partition 7
Partition 8: [3821]	Option [8] = Partition 8

Trouble Latch

VHFWIRQ ^6366 '=RSWIRQ ^9'

With the Trouble Latch feature disabled, when a trouble occurs and is corrected, the trouble is automatically cleared and no longer displayed. With the Trouble Latch feature enabled, the trouble will remain displayed until it is manually cleared by the user. To clear the trouble, the user must enter the trouble display and then exit the trouble display. For LCD keypads, press **[CLEAR]** to exit.

Only troubles that have been corrected can be cleared. If a trouble has not been corrected, it will continue to be displayed even if the user tries to clear the trouble by using the method described above.

Restrict Arming on Supervision Loss

VHFWIRQ ^6367 '=RSWIRQ ^7'

(default = **disabled**) When enabled, arming is restricted if a supervision loss signal from the Magellan Wireless System RTX3 is received.

Restrict Arming on Tamper

VHFWIRQ ^6367 '=RSWIRQ ^;

(default = **disabled**) When enabled, the control panel prevents arming if it detects a tamper on a zone or module page 25. Partitions will not arm until the Installer Code is entered and the tamper trouble conditions are corrected.

Restrict Arming on AC Failure

VHFWIRQ ^6368 '=RSWIRQ ^4'

(default = **disabled**) When enabled, the control panel prevent arming if it detects a loss of AC power.

Restrict Arming on Battery Failure

VHFWIRQ ^6368 '=RSWIRQ ^5'

(default = **disabled**) When enabled, the control panel prevents arming if it detects a battery loss or if the battery voltage is less than 10.5V.

Restrict Arming on Bell or Auxiliary Failure

VHFWIRQ ^6368 '=RSWIRQ ^6'

(default = **disabled**) When enabled, the control panel prevents arming if:

- ◆ the bell or siren is disconnected
- ◆ the Bell Output has exceeded its current limits
- ◆ the Auxiliary Outputs have exceeded their current limits

Restrict Arming on TLM Failure

VHFWIRQ ^6368 '=RSWIRQ ^7'

(default = **disabled**) When enabled, the control panel can prevent arming if it is unable to access the telephone line.

Restrict Arming on Module Troubles

VHFWIRQ ^6368 '=RSWIRQ ^8'

(default = **disabled**) When is enabled, the control panel uses the same Restrict Arming options for the modules connected to the Digiplex bus.

Vhfwlrq ^6368 '=Rswlrq ^;

(default = disabled) When is enabled, the control panel restricts arming if on failure to communicate if trouble in group dialer/GSM and/or IP.

Restrict Arming on Anti Mask Troubles

Vhfwlrq ^635<' '=Rswlrq ^8'

(default = disabled) When is enabled, the control panel restricts arming if trouble in Anti-Mask.

Timed Auto-Arming

(default = **disabled**) The control panel arms the selected partition every day at the time set. A 60-second Exit Delay (default value) triggers before the partition arms. It can be cancelled or postponed by entering a valid access code. If zones are open, the control panel arms the partition and considers all open zones as temporarily bypassed (except 24hr. zones). The control panel transmits the Auto-Arming report code programmed in section [3910]. The control panel will transmit the **Late to Close** report code programmed in section [3912]. Enable option [1] in the desired section:

Partition 1: [3122]	Partition 3: [3322]	Partition 5: [3522]	Partition 7: [3722]
Partition 2: [3222]	Partition 4: [3422]	Partition 6: [3622]	Partition 8: [3822]

Auto-Arm Timer

Enter the time when the partition should arm in the desired section:

Partition 1: [3101]	Partition 3: [3301]	Partition 5: [3501]	Partition 7: [3701]
Partition 2: [3201]	Partition 4: [3401]	Partition 6: [3601]	Partition 8: [3801]

Postpone Auto-Arming

(default = **000**) It is possible to postpone auto-arming for a preset amount of time by entering a valid user code during the exit delay. The delay is set by entering a number between 001 and 255 in the appropriate section. That number represents for how many increments of 15 minutes the arming will be postponed.

Partition 1: [3120]	Partition 3: [3320]	Partition 5: [3520]	Partition 7: [3720]
Partition 2: [3220]	Partition 4: [3420]	Partition 6: [3620]	Partition 8: [3820]

No Movement Auto-Arming

(default = **disabled**) If no movement occurs in a partition for the specified period, the control panel will automatically arm that partition. The Auto-Arming Option determines the arming method. The control panel will transmit the *No Movement* report code programmed in section [3913] upon arming. The control panel will always transmit the *Late to Close* report code [3912]. Enable option [2] in the desired section:

Partition 1: [3122]	Partition 3: [3322]	Partition 5: [3522]	Partition 7: [3722]
Partition 2: [3222]	Partition 4: [3422]	Partition 6: [3622]	Partition 8: [3822]

No Movement Timer

(default = **000**) Select the section corresponding to the desired partition and program the time without movement necessary before the control panel will arm and/or send the *No Movement* report code. If No Movement Auto-Arming is disabled, the control panel can still send the *No Movement* report code. Enter the time period (001 to 255 x 5 minutes, 000 = disabled) when the partition should arm in the desired section:

Partition 1: [3107]	Partition 3: [3307]	Partition 5: [3507]	Partition 7: [3707]
Partition 2: [3207]	Partition 4: [3407]	Partition 6: [3607]	Partition 8: [3807]

No Movement Schedule

It is possible to program the No-movement arming option for each partition to follow a schedule. These schedules, which function like access schedules, will ensure that No-Movement arming only occurs during these specified periods and not at any moment when there is no movement. When option [8] is enabled, access is permitted during the programmed holidays page 42.

No Movement Schedule

Partition 1: [3131]	Partition 3: [3331]	Partition 5: [3531]	Partition 7: [3731]
Partition 2: [3231]	Partition 4: [3431]	Partition 6: [3631]	Partition 8: [3831]

Option	Day	Option	Day
[1]	Sunday (S)	[5]	Thursday (T)
[2]	Monday (M)	[6]	Friday (F)
[3]	Tuesday (T)	[7]	Saturday (S)
[4]	Wednesday (W)	[8]	Holidays (H)

Auto-Arming Options

(default = **disabled**) When using the Auto-Arming features, the control panel can Force arm or Stay arm the partitions. To Auto-Arm using Stay arming, enable option [3] in the desired section:

Partition 1: [3122]	Partition 3: [3322]	Partition 5: [3522]	Partition 7: [3722]
Partition 2: [3222]	Partition 4: [3422]	Partition 6: [3622]	Partition 8: [3822]

Switch To Stay Arming

If no Entry Delay zones are opened and closed during the Exit Delay after Regular arming a partition, the control panel can switch from Regular arming to Stay arming. Enable the option in the desired section:

Partition 1: [3121] Option [1]	Partition 5: [3521] Option [5]
Partition 2: [3221] Option [2]	Partition 6: [3621] Option [6]
Partition 3: [3321] Option [3]	Partition 7: [3721] Option [7]
Partition 4: [3421] Option [4]	Partition 8: [3821] Option [8]

Always Force Arm when Regular Arming

(default = **disabled**) When enabled for a particular partition, the system will Force arm that partition whenever Regular or Force arming is activated. Stay and Instant arming are not affected by this feature. An event will be generated for every zone bypassed in that manner. Another event will be generated when the zone will be closed. Enable option [8] in the desired section:

Partition 1: [3123]	Partition 3: [3323]	Partition 5: [3523]	Partition 7: [3723]
---------------------	---------------------	---------------------	---------------------

Partition 2: [3223]	Partition 4: [3423]	Partition 6: [3623]	Partition 8: [3823]
---------------------	---------------------	---------------------	---------------------

Auto Force on Stay Arming

(default = **disabled**) When enabled for a particular partition, the system will Force arm that partition whenever Stay arming is activated. An event will be generated for every zone bypassed in that manner. Another event will be generated when the zone will be closed. Enable option [4] in the desired section

Partition 1: [3126]	Partition 3: [3326]	Partition 5: [3526]	Partition 7: [3726]
Partition 2: [3226]	Partition 4: [3426]	Partition 6: [3626]	Partition 8: [3826]

Follow Zone Switches to Entry Delay 2

(default = **enabled**) When enabled and an Entry Delay zone is bypassed, an armed Follow Zone (page 15) that opens without an Entry Delay being triggered will switch to the partition's Entry Delay 2. Enable option [8] in the desired section:

Partition 1: [3122]	Partition 3: [3322]	Partition 5: [3522]	Partition 7: [3722]
Partition 2: [3222]	Partition 4: [3422]	Partition 6: [3622]	Partition 8: [3822]

One-Touch Features

(default = **disabled**) The One-Touch features can arm or disarm a partition, access Bypass Programming, or display the Event Buffer by pressing and holding a specific key for 2 seconds instead of entering an access code. If the keypad is assigned to more than one partition, the feature must be enabled in the corresponding partitions. Select the section corresponding to the desired partition and enable or disable the desired options:

Partition 1: [3125]	Partition 3: [3325]	Partition 5: [3525]	Partition 7: [3725]
Partition 2: [3225]	Partition 4: [3425]	Partition 6: [3625]	Partition 8: [3825]

Option	One-Touch Feature	One-Touch Key
[1]	Regular Arming	[ARM]
[2]	Stay Arming	[STAY]
[3]	Instant Arming	[5]
[4]	Force Arming	[FORCE]
[5]	Stay/Instant Disarming	[DISARM]
[6]	Bypass Programming	[BYP]
[7]	Event Record Display	[7]

Exit Delay

(default = **060**) The Exit Delay is the amount of time users have to leave the protected area before arming. It applies to all zones, except 24Hr Zones. Program the Exit Delay from 001 to 255 seconds:

Partition 1: [3108]	Partition 3: [3308]	Partition 5: [3508]	Partition 7: [3708]
Partition 2: [3208]	Partition 4: [3408]	Partition 6: [3608]	Partition 8: [3808]

Exit Delay Termination

(default = **enabled**) The control panel can reduce the Exit Delay to 7 seconds when an Entry Delay zone is opened and closed during the delay. Enable option [4] in the desired section:

Partition 1: [3122]	Partition 3: [3322]	Partition 5: [3522]	Partition 7: [3722]
Partition 2: [3222]	Partition 4: [3422]	Partition 6: [3622]	Partition 8: [3822]

No Exit Delay on Remote Arm

(default = **enabled**) When a user arms by using a remote control from the Magellan Wireless System (RTX3), the control panel will cancel the Exit Delay and immediately arm the partition. Enable option **[8]** in the desired section:

Partition 1: [3125]	Partition 3: [3325]	Partition 5: [3525]	Partition 7: [3725]
Partition 2: [3225]	Partition 4: [3425]	Partition 6: [3625]	Partition 8: [3825]

Special Arming Exit Delay

(default = **060**) This allows to set an exit delay in seconds for a special arming. Special arming are any arming that do happen without interacting with a keypad (i.e.: scheduled arming, keyswitch arming, BabyWare arming, no movement arming, etc.)

Partition 1: [3130]	Partition 3: [3330]	Partition 5: [3530]	Partition 7: [3730]
Partition 2: [3230]	Partition 4: [3430]	Partition 6: [3630]	Partition 8: [3830]

Keypad Lock-out Feature

(default = **005**) If a consecutive number of invalid codes are entered into a keypad, the control panel can be set to lockout access from all the keypads in the partition for a specified period. Program the number of consecutive invalid codes from 001 to 255 (000 = disabled) into the desired section:

Partition 1: [3105]	Partition 3: [3305]	Partition 5: [3505]	Partition 7: [3705]
Partition 2: [3205]	Partition 4: [3405]	Partition 6: [3605]	Partition 8: [3805]

(default = **015**) Program the duration of the keypad lockout from 001 to 255 minutes into the desired section. Programming 000 into these sections will not lockout the keypad, the control panel will transmit the Keypad Lockout report code programmed in section **[3937]**.

Partition 1: [3106]	Partition 3: [3306]	Partition 5: [3506]	Partition 7: [3706]
Partition 2: [3206]	Partition 4: [3406]	Partition 6: [3606]	Partition 8: [3806]

Bell Squawk

The control panel can activate the bell output briefly causing the bell or siren to squawk to alert users that a partition is being armed, disarmed or that an Entry or Exit Delay was triggered. Enable or disable the desired option (off = disabled):

Partition 1: [3124]	Partition 3: [3324]	Partition 5: [3524]	Partition 7: [3724]
Partition 2: [3224]	Partition 4: [3424]	Partition 6: [3624]	Partition 8: [3824]

Option	Bell Squawk on:	Description
[1]	Disarming	Emits 2 squawks upon disarming (default = disabled)
[2]	Arming	Emits 1 squawk upon arming (default = disabled)
[3]	Auto-Arming	Emits 1 squawk every second for 60s before Auto-Arming a partition. Emits a series of 3 squawks every second for 10s before arming (default = disabled)
[4]	Exit Delay	Emits 1 squawk every second during the Exit Delay. Emits a series of 3 squawks every second during the final 10 seconds of the Exit Delay (default = disabled)
[5]	Entry Delay	Emits 1 squawk every second during the Entry Delay (default = disabled)
[6]	Remote Arming/Disarming	Emits 1 squawk upon arming and 2 squawks upon disarming with a remote control (using the Magellan Wireless System, RTX3) (default = enabled)

Ring-back

After disarming the system, the control panel can warn the user that there was an alarm and that it may be dangerous to enter by having the keypad beep 10 times and/or by squawking the bell 10 times. The user should leave immediately and contact the monitoring station from a secure location. Select the section that corresponds to the desired partition and enable or disable the desired option (off = disabled) (default = **disabled**):

Partition 1: [3124]	Partition 3: [3324]	Partition 5: [3524]	Partition 7: [3724]
Partition 2: [3224]	Partition 4: [3424]	Partition 6: [3624]	Partition 8: [3824]

[7]	Bell Ring-back	Bell or siren emits 10 squawks
[8]	Keypad Ring-back	Keypad emits 10 beeps

Maximum Bypass Entries

(default = **000**) The Maximum Bypass Entries feature limits the number of zones that can be bypassed in each partition. Enter any value between 001 and 096 (000 = no limit).

Partition 1: [3115]	Partition 3: [3315]	Partition 5: [3515]	Partition 7: [3715]
Partition 2: [3215]	Partition 4: [3415]	Partition 6: [3615]	Partition 8: [3815]

Display "Bypass" If Armed

VHFWRQ ^6 3 6 6 '=R SWIRQ ^8 `

(default = **enabled**) When enabled, the keypads will not display that zones have been bypassed while the system is armed.

Alarm Options

Bell/Alarm Output

(default = **only option [1] enabled**) When an alarm condition is detected in a partition, the control panel can trigger the on-board BELL output enabling any bells or sirens connected to it. In section **[3032]** enable the option to enable the bell output in the desired partition (off = disabled):

Partition 1: Option [1]	Partition 5: Option [5]
Partition 2: Option [2]	Partition 6: Option [6]
Partition 3: Option [3]	Partition 7: Option [7]
Partition 4: Option [4]	Partition 8: Option [8]

Bell Cut-off Timer

(default = **004**) After an audible alarm, the bell or siren will stop once the partition is disarmed or when the Bell Cut-Off Timer has elapsed. Enter any value between 001 and 255 minutes:

Partition 1: [3113]	Partition 3: [3313]	Partition 5: [3513]	Partition 7: [3713]
Partition 2: [3213]	Partition 4: [3413]	Partition 6: [3613]	Partition 8: [3813]

No Bell Cut-Off on Fire Alarm

VHFWIRQ ^6363 '=RSWIRQ ^5`

(default = **disabled**) The control panel can disable the Bell Cut-Off Timers when alarms are generated from zones defined as Standard or Delayed Fire Zones (see *section* on page 15). The BELL output will remain enabled until a user disarms the partition in alarm.

Recycle Alarm Rate

(default = **000**) The control panel re-verifies the zone status during an alarm at a programmed rate once the Bell Cut-Off Timer and the Recycle Delay elapse. If open zones remain, the control panel will regenerate the alarm. Enter the number of times from 001 to 255 (000 = no limit) in one armed period that the control panel will re-verify the zone status:

Partition 1: [3117]	Partition 3: [3317]	Partition 5: [3517]	Partition 7: [3717]
Partition 2: [3217]	Partition 4: [3417]	Partition 6: [3617]	Partition 8: [3817]

Recycle Delay

(default = **000**) The Recycle Delay is the amount of time the control panel will wait after the Bell Cut-off occurs before re-verifying the zone status. Program the Recycle Delay from 001 to 255 minutes (000 = disabled):

Partition 1: [3116]	Partition 3: [3316]	Partition 5: [3516]	Partition 7: [3716]
Partition 2: [3216]	Partition 4: [3416]	Partition 6: [3616]	Partition 8: [3816]

Wireless Transmitter Supervision Options

VHFWIRQ ^6367 '=RSWIRQV ^4`DQG ^5`

When the control panel detects a Supervision Loss, the control panel can generate an alarm and/or trouble, unless the Wireless Transmitter Supervision Option is disabled.

NOTE: The Supervision feature must be enabled in the Magellan Wireless System (RTX3) for this feature to function.

[1]	[2]	Description
OFF	OFF	Disabled (default): Displays zone open on the keypads, therefore will generate an alarm when the system is armed. <i>Not permitted on UL systems.</i>
OFF	ON	Generates Trouble Only (when armed or disarmed): The control panel displays <i>Zone Fault</i> in the Trouble Display and transmits the defined report code (see <i>section</i> on page 28).

ON	OFF	When disarmed: Generates Trouble Only The control panel displays <i>Zone Fault</i> in the Trouble Display and transmits the defined report code (see <i>section</i> on page 28). When armed: Follows Zone Alarm Type The control panel follows the zone's alarm type (see <i>section</i> on page 17).
ON	ON	When disarmed: Generates Audible Alarm The control panel displays <i>Zone Fault</i> in the Trouble Display, transmits the defined report code (see <i>section</i> on page 28), and generates an audible alarm. When armed: Follows Zone Alarm Type The control panel follows the zone's alarm type (see <i>section</i> on page 17).

Supervision Bypass Options

VHFWIRQ ^6367 '=RSWIRQ ^6`

(default = **disabled**) When enabled in section **[3034]**, the Wireless Transmitter Supervision Options will follow the zone's bypass definition. The control panel will not perform any action if a supervision loss occurs on a bypassed zone. When disabled, it will ignore the bypass definition and will follow the option set in *section* .

Police Code Timer

(default = **000**) If an alarm condition occurs on a zone, the control panel generates an alarm and triggers the Police Code Timer. The Police Code programmed in **[3934]** will only be sent if one of the following conditions occurs during the delay:

1. An alarm occurs on another zone.
2. The zone in alarm restores and reoccurs.

Key in the desired 3-digit delay value (001 to 255 minutes, 000 = disabled) into the section corresponding to the desired partition:

Partition 1: [3118]	Partition 3: [3318]	Partition 5: [3518]	Partition 7: [3718]
Partition 2: [3218]	Partition 4: [3418]	Partition 6: [3618]	Partition 8: [3818]

Refer to *Intellizone Options* on page 17 to set it up so that a police code is only generated on Zone Crossing.

Tamper Recognition Options

VHFWIRQ ^6367 '=RSWIRQV ^8`DQG ^9`

When the control panel detects a tamper or wire fault on a zone or on an expansion module, the control panel can generate an alarm and/or trouble, as shown in the table below.

[5]	[6]	Description
OFF	OFF	Disabled (default): Displays zone open on the keypads, but will not generate an alarm or trouble. <i>Not permitted on UL systems.</i>
OFF	ON	Generates Trouble Only (when armed or disarmed): The control panel displays <i>Zone Fault</i> in the Trouble Display and transmits the defined report code (see <i>section</i> on page 28).
ON	OFF	When disarmed: Generates Trouble Only The control panel displays <i>Zone Fault</i> in the Trouble Display and transmits the defined report code (see <i>section</i> on page 28). When armed: Follows Zone Alarm Type The control panel follows the zone's alarm type (see <i>section</i> on page 17).
ON	ON	When disarmed: Generates Audible Alarm The control panel displays <i>Zone Fault</i> in the Trouble Display, transmits the defined report code (see <i>section</i> on page 28), and generates an audible alarm. When armed: Follows Zone Alarm Type The control panel follows the zone's alarm type (see <i>section</i> on page 17).

Tamper Bypass Options

VHFWIRQ ^6367 '=RSWIRQ ^: \'

(default = **enabled**) When enabled in section **[3034]**, the control panel will ignore the zone's bypass definition and will follow the option set in *section* (page 25) if a tamper or wire fault occurs on a bypassed zone. When disabled, Tamper Recognition follows the zone's bypass definition. This means that the control panel will not perform any action if a tamper or wire fault occurs on a bypassed zone.

Keypad Panic Options

(default = **disabled**) The control panel can generate an alarm (audible, fire or report only) by pressing the keypad Panic key(s). Refer to the table below for the keypad Panic keys. In the section that corresponds to the desired partition, enable or disable options **[1]** through **[6]**:

Partition 1: [3123]	Partition 3: [3323]	Partition 5: [3523]	Partition 7: [3723]
Partition 2: [3223]	Partition 4: [3423]	Partition 6: [3623]	Partition 8: [3823]

Option	Feature	Press and Hold 2 Seconds:
[1]	Panic 1*	LCD keypads: Keys [1] and [3] simultaneously
[2]	Panic 2*	LCD keypads: Keys [4] and [6] simultaneously
[3]	Panic 3	LCD keypads: Keys [7] and [9] simultaneously

Option	Alarm Type
[4]	Panic 1:* ON = Audible OFF = Report Only
	Panic 2:* ON = Audible OFF = Report Only
[6]	Panic 3: ON = Fire OFF = Report Only

Report Only

The keypad emits a single confirmation beep and transmits the report code.

Audible Alarm

The control panel activates the BELL output until a user cancels the alarm or when the Bell Cut-Off Timer elapses .

Fire Alarm

Same as audible operation, except that the bell/siren output will be pulsed.

*** UL Note:** For UL Listed systems, all emergency non-medical and auxiliary panic alarms will be report only.

Event Reporting

Figure 16: Event Reporting

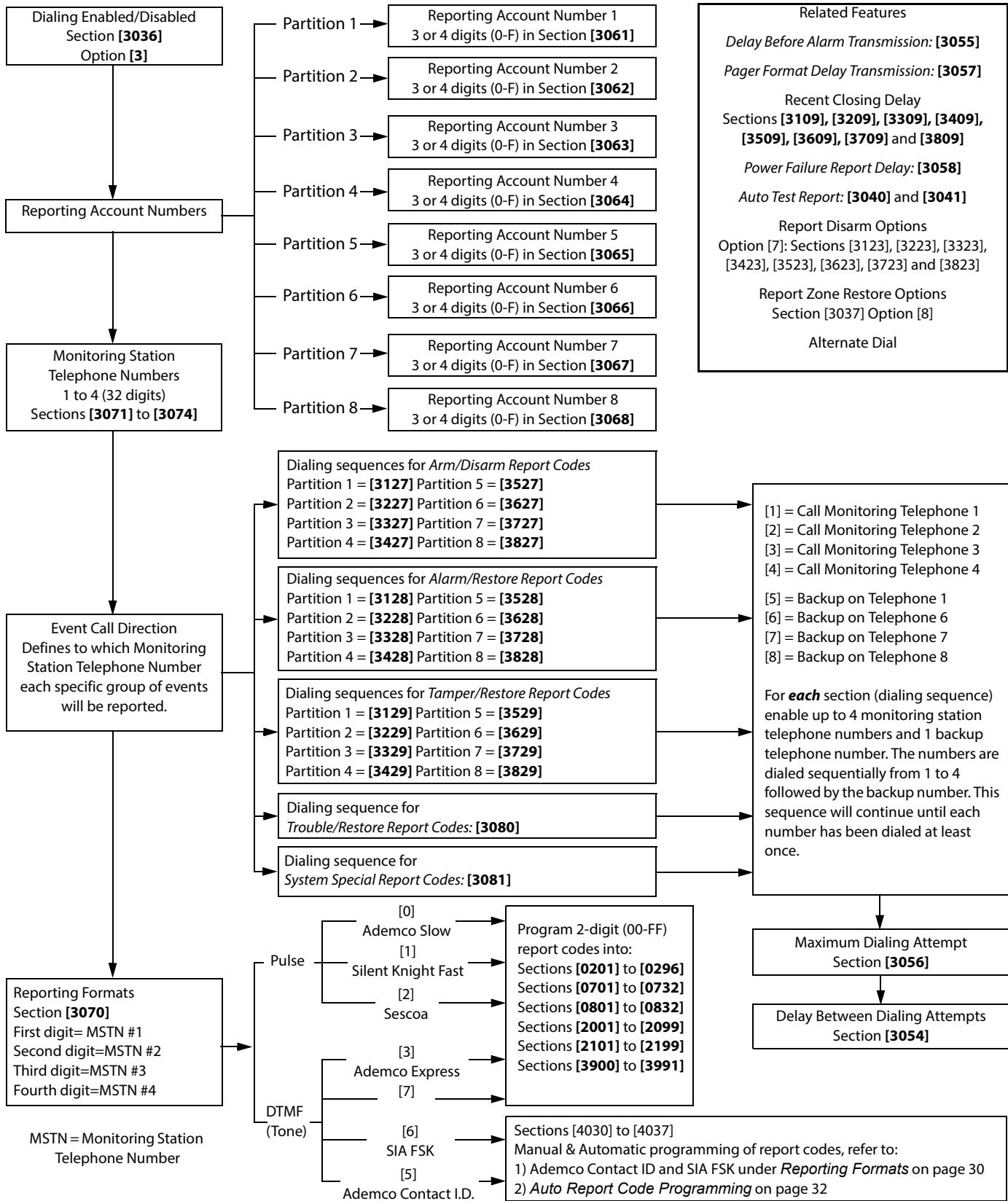

Reporting Enabled

VHFWIRQ ^6369 \=RSWIRQ ^6 \

(default = **disabled**) If enabled, the control panel verifies if a report code was programmed in the section corresponding to event that happened. If a report code is programmed, the control panel dials the monitoring station telephone number. When the monitoring station answers, the control panel transmits the system account code and the programmed report code.

IP/GSM / GPRS Reporting

For more information on setting up IP/GPRS reporting please refer to the PCS Series Reference and Installation manual or the IP150 Installation manual.

Report Codes

Report codes are 2-digit or 1-digit hexadecimal value. The Ademco Slow, Silent Knight, Sescosa and Pager Formats support 1-digit report codes. The transmission is defined by these two items: **Reporting Formats** (see *section* on page 30) and **Event Call Direction** (see *section* on page 31). If you are using the Ademco CID or SIA formats, an Auto Report Code Programming feature is available (see *section* on page 32).

Zone Alarm and Alarm Restore Report Codes

VHFWIRQ ^3733 \=IUVV DQG VHFRQG EUDFNHWV

VHFWIRQV ^3534 \WR ^35<9 \=IUVV DQG VHFRQG EUDFNHWV

The first set of 2 digits in the sections refer to the Alarm Report Codes that identify which zones generated an alarm. The second set of 2 digits refer to the Alarm Restore Report Codes when a zone closes or once the bell has cut-off (see *section* on page 25). Refer to Zone Restore Report Options in (see *section* on page 32).

Tamper and Tamper Restore Report Codes

section [0400]: Third and Fourth Brackets

VHFWIRQV ^3534 \WR ^35<9 \=WKIIG DQG IRXUWK EUDFNHWV

The third set of 2 digits refer to the Tamper Report Codes. The fourth set of 2 digits refer to the Tamper Restore Report Codes.

Keyswitch Arming

VHFWIRQV ^3:34 \WR ^3:65 \

Each section from **[0701]** to **[0732]** corresponds to a keyswitch from 1 to 32. The control panel can send the report code to the monitoring station identifying which keyswitch was used to arm. It will not send report codes for keyswitches that are defined with the PGM Activation definition.

Keyswitch Disarming

VHFWIRQV ^3;34 \WR ^3;65 \

Each section from **[0801]** to **[0832]** corresponds to a keyswitch from 1 to 32. The control panel can send a report code to the monitoring station identifying which keyswitch was used to disarm. It can transmit the report codes every time a partition is disarmed or only following an alarm. It will not send report codes for keyswitches that are defined with the PGM Activation definition.

Access Codes Arming

VHFWIRQV ^5334 \WR ^53<< \

A report code can be programmed for each user access code from 01 to 98 in sections **[2001]** to **[2098]**. User access codes from 99 to 999 use a common report code in section **[2099]**. The control panel can send the report code identifying which access code was used to arm the system.

Access Codes Disarming

VHFWIRQV ^5434 \WR ^54<< \

A report code can be programmed for each user access code from 01 to 98 in sections **[2101]** to **[2198]**. User access codes from 99 to 999 use a common report code programmed in section **[2199]**. The control panel can send the report code to the monitoring station identifying which access code was used to disarm the system. It can be transmitted when a partition is disarmed or only following an alarm. Also, see page 32.

Special System Reporting Codes

When the system generates one of the following events, the control panel can send the report code to the monitoring station identifying the event:

[3900]	Cold Start	control panel re-starts after complete shutdown (total power loss)
[3901]	Warm Start	control panel resets due to sudden problem other than power loss
[3902]	Test Report	report generated automatically (see <i>section</i>)
[3903]	Listen-In to Follow	Listen-In module attempts to start a Listen-In session
[3904]	BabyWare Login Request	communication attempted between BabyWare and control panel (Callback only)
[3905]	BabyWare Log Off	control panel ends communication with BabyWare
[3906]	Installer In	installer enters programming mode
[3907]	Installer Out	installer exits programming mode
[3908] to [3909]		Future Use

Special Arming Report Codes

When the partition arms using a special arming feature, the control panel can send the report code identifying how the system was armed.

[3910]	Auto-Arming	when Auto-Arming (see <i>section</i> on page 22)
[3911]	PC Arming	system armed using BabyWare or NEware software
[3912]	Late to Close	when Auto-Arming (see <i>section</i> on page 22)
[3913]	No Movement	when No Movement Auto-Arming (see <i>section</i> on page 23)
[3914]	Partial Arming	when partitions are Stay, Instant or Force armed or armed with bypassed zones
[3915]	Quick Arming	partitions armed with a One-Touch Arming feature (see <i>section</i> on page 23)
[3916]	Early to Close	partition armed before Arming Report Schedule (see <i>section</i> on page 30)
[3917]	Late to Close	partition armed after Arming Report Schedule (see <i>section</i> on page 30)
[3918]	Remote Arm	partition armed with the InTouch Voice-Assisted Arm/Disarm Module (VDMP3)
[3919]	Closing Delinquency	Partition hasn't been armed before the programmed Closing Delinquency Timer elapsed (see <i>section</i> on page 32).

Special Disarming Report Codes

When using one of the special disarming features listed below, the control panel can send the report code identifying how the system was disarmed. Also, refer to *Disarm Reporting Options* in *section* on page 32.

[3920]	Cancel Auto-Arm	partition disarms during the Auto-Arm's delay (see <i>section</i> on page 22)
[3921]	Quick Disarm	partition disarms using One-Touch Disarming feature (see <i>section</i> on page 23)
[3922]	PC Disarm	system disarmed using BabyWare or NEware software
[3923]	PC Disarm after Alarm	system disarmed using BabyWare or NEware software after an alarm occurs
[3924]	Cancel Alarm	indicates that an alarm was cancelled even though the system was not armed when the alarm occurred.
[3925]	Future Use	
[3926]	Early to Open	partition disarmed before Disarming Schedule (see <i>section</i> on page 30)
[3927]	Late to Open	partition disarmed after Disarming Schedule (see <i>section</i> on page 30)
[3928]	Remote Disarm	partition disarmed with InTouch Voice-Assisted Arm/Disarm Module (ADM2)

Special Alarm Report Codes

[3930]	Emergency Panic (non-medical)	the panic keys [1] and [3] were pressed (see <i>section</i> on page 26)
[3931]	Auxiliary Panic	the panic keys [4] and [6] were pressed (see <i>section</i> on page 26)
[3932]	Fire Panic	the panic keys [7] and [9] were pressed (see <i>section</i> on page 26)
[3933]	Recent Closing	an alarm is generated within the <i>Recent Close Delay</i> (see <i>section</i> on page 31)
[3934]	Police Code	Confirmation of an alarm condition occurred during the Police Code Timer's delay (see <i>section</i> on page 25).
[3935]	Auto Zone Shutdown	the control panel stops regenerating alarms on a zone during the same armed period (see <i>section</i> on page 16)
[3936]	Duress	a Duress enabled access code is keyed in (see <i>Appendix 3: Keypad Installation Instructions</i> on page 51)
[3937]	Keypad Lockout	too many invalid codes entered (see <i>section</i> on page 24)

System Trouble Codes

Section	Data	Description
[3940]	/ /	TLM trouble
	/ /	AC failure
	/ /	Battery failure
	/ /	Auxiliary supply
[3941]	/ /	Bell output trouble
	/ /	Clock loss
	/ /	Fire loop trouble
	/ /	Panel Tamper
[3950]	/ /	Wireless transmitter battery low
	/ /	Wireless transmitter supervision trouble
	/ /	Future use
	/ /	Future use
[3951]	/ /	Phone number 1 fail to communicate
	/ /	Phone number 2 fail to communicate
	/ /	Phone number 3 fail to communicate
	/ /	Phone number 4 fail to communicate
[3960]	/ /	Combus fault
	/ /	Module tamper
	/ /	ROM check error
	/ /	Module TLM
[3961]	/ /	Module failure to communicate
	/ /	Printer fault
	/ /	Module AC failure
	/ /	Module battery failure
[3962]	/ /	Module auxiliary failure
	/ /	Module IP Receiver supervision
	/ /	Module IP Receiver fail to communicate
	/ /	Module IP Receiver unregistered
[3963]	/ /	Direct light
	/ /	Module Rf Interference
	/ /	Module low voltage
	/ /	Module self-test error
[3964]	/ /	Module LAN trouble
	/ /	Module WAN trouble
	/ /	Future use
	/ /	Future use

System Trouble Restore Codes

Section	Data	Description
[3970]	/ /	TLM restore
	/ /	AC failure restore
	/ /	Battery failure restore
	/ /	Auxiliary supply restore
[3971]	/ /	Bell output trouble restore
	/ /	Clock loss restore
	/ /	Fire loop trouble restore
	/ /	Panel tamper restore
[3980]	/ /	Wireless transmitter battery low restore
	/ /	Wireless transmitter supervision trouble restore
	/ /	Future use
	/ /	Future use
[3990]	/ /	Combus fault restore
	/ /	Module tamper restore
	/ /	ROM check error restore
	/ /	Module TLM restore
[3991]	/ /	Module failure to communicate restore
	/ /	Printer fault restore
	/ /	Module AC failure restore
	/ /	Module battery failure restore
[3992]	/ /	Module auxiliary failure restore
	/ /	Module IP Receiver supervision restore
	/ /	Module IP Receiver fail to communicate restore
	/ /	Module IP Receiver unregistered restore
[3993]	/ /	Direct light restore
	/ /	Module Rf Interference restore
	/ /	Module low voltage restore
	/ /	Module self-test error restore
[3994]	/ /	Module LAN trouble restore
	/ /	Module WAN trouble restore
	/ /	Future use
	/ /	Future use

NOTE: If the Telephone Line Monitoring (see *section*) is disabled, the control panel will not transmit the TLM report code.

Report Arming and Disarming

These features identify when partitions should be armed or disarmed. It allow the control panel to report changes from the schedule.

Arming and Disarming Report Schedules

Arming and Disarming Report Schedules identify the days and times that a partition should be armed and disarmed. Each schedule consists of 2 programmable time periods called Intervals that determine the time span and days when the partition should be armed or disarmed (see *Figure 17*). Schedules are enabled when they are programmed.

Figure 17: Example of an Arming and a Disarming Report Schedule

Section [3102]: Arming Schedule (partition 1)
Interval 1: Start Time 16:55 End Time 17:30 Options 2, 3, 4, 5 & 6

Section [3103]: Disarming Schedule (partition 1)
Interval 1: Start Time 08:50 End Time 09:10 Options 2, 3, 4, 5, 6

On Monday, Tuesday, Wednesday, Thursday and Friday:

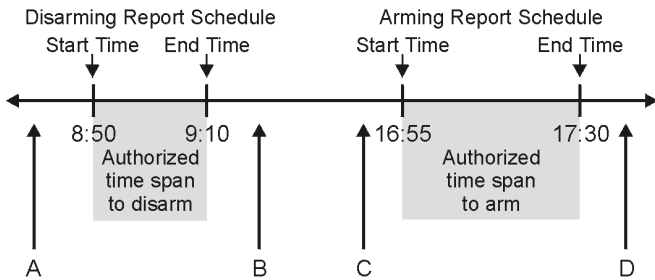

- A = If partition is disarmed, Early to Open report code sent.
- B = If partition is disarmed, Late to Open report code sent.
- C = If partition is armed, Early to Close report code sent.
- D = If partition is armed, Late to Close report code sent.

Program the Start Time and End Time according to the 24-hour clock and enable the options representing the desired Days for the desired partition. When option [8] is enabled, access is permitted during the programmed holidays (see *section* on page 42).

Arming Report Schedule

Partition 1: [3102]	Partition 3: [3302]	Partition 5: [3502]	Partition 7: [3702]
Partition 2: [3202]	Partition 4: [3402]	Partition 6: [3602]	Partition 8: [3802]

Disarming Report Schedule

Partition 1: [3103]	Partition 3: [3303]	Partition 5: [3503]	Partition 7: [3703]
Partition 2: [3203]	Partition 4: [3403]	Partition 6: [3603]	Partition 8: [3803]

Option	Day	Option	Day
[1]	Sunday (S)	[5]	Thursday (T)
[2]	Monday (M)	[6]	Friday (F)
[3]	Tuesday (T)	[7]	Saturday (S)
[4]	Wednesday (W)	[8]	Holidays (H)

Arming/Disarming Schedule Tolerance Window

(default = 000) The Arming/Disarming Schedule Tolerance Window lengthens the partition's Arming/Disarming Schedule for some users. User access codes with Add Tolerance Windows to Schedules enabled have the number of minutes programmed in these sections added before and after the corresponding partition's schedule. Enter any value between 001 and 255 to determine Arming/Disarming Schedule Tolerance Window in minutes.

Partition 1: [3104]	Partition 3: [3304]	Partition 5: [3504]	Partition 7: [3704]
Partition 2: [3204]	Partition 4: [3404]	Partition 6: [3604]	Partition 8: [3804]

NOTE: The Arming/Disarming Schedule Tolerance Window applies to the Arming and Disarming Report Schedules only (*section*). The Arming/Disarming Schedule Tolerance Window does not apply to Access Schedules (*section* on page 42).

Monitoring Station Phone Number

VHFWRQV ^63:4\WR ^63:7`

The control panel can dial up to 4 different monitoring station telephone numbers. Sections [3071] to [3074] represent monitoring station telephone numbers 1 through 4. Enter any digit up to a maximum of 32.

Table 5: Special Telephone Number Keys

Functions	Key	
*	[STAY]	[#] (Press the key until the desired letter/symbol appears)
#	[FORCE]	
Switch to Tone Dialing (T)	[ARM]	
Wait for second dial tone (W)	[DISARM]	
4-second pause (P)	[BYP]	—
Insert	[MEM]	—
Delete	[TRBL]	—
Delete from cursor to end	[ACC]	Left action key (Clear)

Account Number

VHFWRQV ^6394\WR ^639;`

(default = 000) All report codes are preceded by a 3- or 4-digit Account Number to ensure correct identification of system events. Account Numbers can be any hexadecimal value from 0 to F.

Table 6: Account Numbers

Section	Account Number	Section [3035], option [6] = disabled	Section [3035], option [6] = enabled
[3061]	Account Number 1	Partition 1	MSTN 1
[3062]	Account Number 2	Partition 2	MSTN 2
[3063]	Account Number 3	Partition 3	MSTN 3
[3064]	Account Number 4	Partition 4	MSTN 4
[3065]	Account Number 5	Partition 5	N/A
[3066]	Account Number 6	Partition 6	N/A
[3067]	Account Number 7	Partition 7	N/A
[3068]	Account Number 8	Partition 8	N/A

NOTE: Only the SIA format supports the [0] = 0 digit in its account numbers. Account numbers that use other reporting formats do not support the [0] = 0 digit. Enter the [STAY] = A digit in its place. When using the SIA Format, and the Account Number Transmission (see *section* on page 30) corresponds to the partition, the control panel only uses the Partition 1 Account Number programmed in section [3061], but the report code includes the partition number.

Account Number Transmission

VHFWRQ ^6368\=RSWRQ ^9`

(default = Partition Account #) When enabled, the account number corresponding to the MSTN that was dialed will be sent regardless of which partition the report originated from. When disabled, the account number that is sent to the monitoring station corresponds to the partition where the event originated, regardless of which MSTN is dialed.

Reporting Formats

VHFWRQ ^63:3`

The control panel can use a number of different reporting formats. Each monitoring station phone numbers should be programmed with the same reporting format unless they are combined with a Pager format. The first digit represents the reporting format (see Table 7) used for Monitoring Station Telephone Number 1, the second digit, Monitoring Station Telephone Number 2, etc.

Compatible Digital Alarm Communication Receivers (DACRs):*

- ◆ Sur-Gard DRL2A
- ◆ Ademco 685
- ◆ Osborne Hoffman Quick Alert II

Table 7: Reporting Formats*

0 = Ademco slow (1400Hz, 1900Hz, 10BPS)	4 = Contact ID Pager
1 = Silent Knight fast (1400Hz, 1900Hz, 20BPS)	5 = Ademco Contact ID
2 = Sescoa (2300Hz, 1800Hz, 20BPS)	6 = SIA FSK
3 = Ademco Express (DTMF 4+2)	7 = Pager

* **UL Note:** Installer must verify the compatibility with of the DACR. Use listed compatible DACRs.

Standard Pulse Formats

The control panel can use the Ademco slow, Silent Knight fast and Sescoa standard pulse reporting formats (see Table 7).

Ademco Express

The Ademco Express is a high-speed reporting format that communicates 2-digit (00 to FF) report codes. The Ademco Express does not use the Contact ID Report Codes.

Contact ID Pager

The control panel will transmit a Contact ID report instead of a user generated numerical code to a pager. The Contact ID report code will come from either the *Automatic Report Code List* on page 46 or the *Contact ID Report Code List* on page 49.

Ademco Contact ID

Ademco Contact ID is a fast communicator format that uses tone reporting. To program the report codes, use the 2-digit hexadecimal values from the *Contact ID Report Codes List* in the "EVOHD Programming Guide". Enter 00 to disable reporting or FF to use the default report code from the Automatic Report Code List in the "EVOHD Programming Guide". To program a set of default Contact ID codes, refer to *section* on page 32.

SIA FSK

SIA FSK is a fast communicator format that uses tone reporting. To program the report codes, enter 00 to disable reporting or any other value to use the default report code from the *Automatic Report Code List* in the "EVOHD Programming Guide". To program a set of default SIA FSK codes, refer to *Auto Report Code Programming* on page 32.

Pager Reporting Format

Using this format allows the control panel to transmit report codes to a pager. A pound symbol "#" is automatically generated after the report code.

Event Call Direction

Event groups can be programmed to dial up to four monitoring station telephone numbers with one used as a backup. The numbers are dialed sequentially, skipping any disabled numbers and stopping once all selected telephone numbers have been reached. If the control panel still fails to report to a monitoring station telephone number after reaching the Maximum Dialing Attempts (see *section* on page 31), the control panel will dial the selected backup telephone number. For each section enable or disable the options:

Troubles and Restore Troubles: [3080]
Special System, Arming, Disarming and Alarm Reporting: [3081]

Access Code and Keyswitch Arming and Disarming

Partition 1: [3127]	Partition 3: [3327]	Partition 5: [3527]	Partition 7: [3727]
Partition 2: [3227]	Partition 4: [3427]	Partition 6: [3627]	Partition 8: [3827]

Zone Alarms and Alarm Restores

Partition 1: [3128]	Partition 3: [3328]	Partition 5: [3528]	Partition 7: [3728]
Partition 2: [3228]	Partition 4: [3428]	Partition 6: [3628]	Partition 8: [3828]

Tampers and Tamper Restores

Partition 1: [3129]	Partition 3: [3329]	Partition 5: [3529]	Partition 7: [3729]
----------------------------	----------------------------	----------------------------	----------------------------

Partition 2: [3229]	Partition 4: [3429]	Partition 6: [3629]	Partition 8: [3829]
----------------------------	----------------------------	----------------------------	----------------------------

(default = **only option [1] enabled**)

Option	Call:	Option	Call (select one only):
[1]	Telephone Number 1	[5]	Backup on Number 1
[2]	Telephone Number 2	[6]	Backup on Number 2
[3]	Telephone Number 3	[7]	Backup on Number 3
[4]	Telephone Number 4	[8]	Backup on Number 4

Maximum Dialing Attempts*

VHFWRQ ^6389`

(default = **008**) The number (001 to 255, 000 = 8 attempts) programmed into section **[3056]** determines how many tries before proceeding to the next number. Also refer to *section* .

* **UL Note:** For UL Listed systems, the maximum dialing attempts must be set to 5 to 10 attempts between the EVOHD's two telephone lines.

Delay Between Dialing Attempts

VHFWRQ ^6387`

(default = **020**) This delay can be set from 001 to 127 seconds.

Alternate Dialing Option

VHFWRQ ^636 : `=RSWRQ ^9`

(default = **disabled**) When enabled, the control panel dials the selected backup telephone number after every failed attempt to contact a monitoring station telephone number. When disabled, the control panel dials the backup telephone number after the Maximum Dialing Attempts (see *section*) to one monitoring station telephone number fail.

Pager Delay

VHFWRQ ^638 : `

(default = **020**) When using the Pager Reporting Format (see *section*), the control panel will wait for the delay period programmed into section **[3057]** before uploading the report codes to the pager. Enter any value between 001 and 127 to determine Pager Delay in seconds.

Recent Close Delay

(default = **000**) If an alarm is generated within the programmed period after arming the partition, the control panel will transmit the *Recent Close* report code programmed into section **[3933]**. Enter any value between 001 and 255 to determine Recent Close Delay in seconds.

Partition 1: [3109]	Partition 3: [3309]	Partition 5: [3509]	Partition 7: [3709]
Partition 2: [3209]	Partition 4: [3409]	Partition 6: [3609]	Partition 8: [3809]

Power Failure Report Delay

VHFWRQ ^638 ; `

(default = **030**) The control panel will delay the transmission of the *AC Failure* report code programmed into section **[3941]** by the period programmed into section **[3058]**. Enter any value between 001 and 255 to determine Power Failure Report Delay in minutes.

Power Failure Restore Report Delay

VHFWRQ ^6393`

(default = **030**) The control panel will delay the transmission of the *AC Failure Restore* report code programmed into section **[3972]** by the period programmed into section **[3060]**. Enter any value between 001 and 255 to determine Power Failure Restore Report Delay in minutes.

Repeat Pager Report Code Transmission

VHFWRQ ^638 < `

{default = **000**} This feature re-sends the report code as specified.

Auto Test Report

VHFWIRQ ^636 : '=RSWIRQV ^6'DQG ^7'DQG

VHFWIRQV ^6373 '/^6374 '/^6375'DQG ^6376 '

The control panel can transmit the test report code programmed into section **[3902]** every hour or after a period of time.

OFF	OFF	Auto Test Report Period (default)	After the number programmed (000 to 255 days, default = 000) in section [3040] , the control panel transmits a report code at the time (00:00 to 23:59, default = 00:00) programmed in section [3041] .
OFF	ON	Timed Test Transmission when Armed/Disarmed	When disarmed: The control panel transmits the code at regular intervals. Program the number of minutes (000 to 255, default = 060) between transmissions in section [3043] . When armed: The control panel transmits the test report code at regular intervals. Program the number of minutes (000 to 255, default = 005) between each transmission in section [3042] .
ON	OFF	Hourly Test Transmission	The control panel will transmit the test report code every hour on the minute value programmed in section [3041] (the last two digits). Note that the first two digits of section [3041] will be ignored.
ON	ON	Timed and Hourly Test Transmission	The test report code will be transmitted when any of the conditions of the second and third options listed above (options [3] = OFF and [4] = ON / options [3] = ON and [4] = OFF) are met.

Disarm Reporting Options

(default = **disabled**) When disabled, the control panel sends the Disarming Report Codes (page 28) every time the partition is disarmed. When enabled, the control panel sends the Disarming Report Codes to the monitoring station only when the partition is disarmed following an alarm. Select the section that corresponds to the desired partition and enable or disable option **[7]**:

Partition 1: [3123]	Partition 3: [3323]	Partition 5: [3523]	Partition 7: [3723]
Partition 2: [3223]	Partition 4: [3423]	Partition 6: [3623]	Partition 8: [3823]

Zone Restore Report Options

VHFWIRQ ^636 : '=RSWIRQ ^ ; '

(default = **disabled**) When disabled, the control panel sends the *Zone Alarm Restore* report codes to the monitoring station when the Bell Cut-Off Timer elapses or when the alarm is disarmed. When enabled, the control panel sends the *Zone Alarm Restore* report codes (see *section*) to the monitoring station as soon as the zone returns to normal (zone closure) or upon disarming.

Auto Report Code Programming

When using either the Contact ID or SIA Reporting Formats (see *section* on page 30), the control panel can automatically program a set of default report codes. The Contact ID Reporting Format can be modified using the manual programming method (see page 31) to program remaining report codes or to change some of the defaults. Enter any of the following sections to set the indicated report codes with the default values (FF) from the *Automatic Report Codes List* in the "EVOHD Programming Guide":

Section	Description
[4030]	Resets all the report code sections to 00 (cleared).
[4031]	Sets all the report code sections to FF (defaults).

Section	Sets to Defaults (FF)	Reset Sections
[4032]	Zone Alarm and Restore Report Codes Tamper and Restore Report Codes	[0201] to [0296]
[4033]	Keyswitch Arming Report Codes Keyswitch Disarming Report Codes Access Code Arming Report Codes Access Code Disarming Report Codes	[0701] to [0732] [0801] to [0832] [2001] to [2099] [2101] to [2199]
[4034]	Special System Report Codes	[3900] to [3909]
[4035]	Special Arming Report Codes Special Disarming Report Codes	[3910] to [3919] [3920] to [3929]
[4036]	Special Alarm Report Codes	[3930] to [3939]
[4037]	Trouble and Restore Report Codes	[3940] to [3991]

Closing Delinquency Timer

(default = **000**; disabled) When a partition in the system is disarmed, the control panel will start the corresponding partition's Closing Delinquency Timer. If the Closing Delinquency Timer elapses before the partition is armed again, EVOHD will transmit a "Closing Delinquency" report code to the monitoring station. Enter a value from 001 to 255 days into the appropriate section. Enter 000 to disable the Closing Delinquency Timer.

Partition 1: [3119]	Partition 3: [3319]	Partition 5: [3519]	Partition 7: [3719]
Partition 2: [3219]	Partition 4: [3419]	Partition 6: [3619]	Partition 8: [3819]

Dialer Options

Telephone Line Monitoring

VHFWIRQ ^6369 \=R SWIRQV ^4 \ DQG ^5 \

When enabled, the system verifies the existence of the main telephone line once every second. After each successful test, the Status LED on the control panel flashes briefly. A line test failure occurs when the TLM detects less than 3 volts for the period defined by the TLM Fail Timer (see *section*). If the line test fails, the control panel will generate one or more conditions as defined by the TLM settings below, until it detects the telephone line again. When the dialer detects a telephone ring, the TLM test stops for 1 minute.

[1]	[2]	Feature	When the line test fails
OFF	OFF	Disabled	TLM disabled (default) .
ON	OFF	Trouble Only	The <i>Communicator</i> trouble appears in the Trouble Display.
OFF	ON	Alarm when Armed	The <i>Communicator</i> trouble appears in the Trouble Display. If the partition is armed, the control panel generates an alarm.
ON	ON	Silent Alarms become Audible	The <i>Communicator</i> trouble appears in the Trouble Display. The control panel switches any triggered <i>Silent Alarm</i> zones or <i>Silent</i> panic alarms to an audible alarm.

TLM Fail Timer

VHFWIRQ ^6386 \

(default = **016**) If the TLM does not detect the existence of the main telephone line for the time programmed in this section, the control panel will generate the condition(s) defined by the TLM options (see *section*). Enter any value between 016 and 255 (value is X2 seconds) into section **[3053]**. Entering a value between 000 and 016 will set the TLM Fail Timer to 32 seconds.

Tone/Pulse Dialing

VHFWIRQ ^6369 \=R SWIRQ ^7 \

(default = **enabled**)

[4]	ON	Tone/DTMF format
[4]	OFF	Pulse dialing format

Pulse Ratio

VHFWIRQ ^6369 \=R SWIRQ ^8 \

(default = **enabled**) When using Pulse dialing (see *section*), select one of two Pulse Ratios. If the selected pulse ratio does not provide adequate results, try the other one.

[5]	ON	North American pulse ratio of 1:1.5
[5]	OFF	European pulse ratio of 1:2

Busy Tone Detection

VHFWIRQ ^6369 \=R SWIRQ ^9 \

(default = **enabled**) When enabled, the control panel immediately hangs up if it receives a busy signal when it dials an outside number.

Switch To Pulse

VHFWIRQ ^6369 \=R SWIRQ ^: \

(default = **disabled**) When is enabled, the control panel switches from tone dialing to pulse dialing on the fifth attempt to report events to the monitoring station. The control panel continues to use pulse dialing until it establishes communication. When the control panel switches to another monitoring station telephone number, it returns to tone dialing and switches back to pulse dialing on the fifth attempt.

Bell On Communication Fail

VHFWIRQ ^6369 \=R SWIRQ ^; \

(default = **disabled**) When enabled and the control panel fails to communicate with the monitoring station when the partition is armed, the control panel can enable the BELL output.

Keypad Beep on Successful Arm or Disarm Report

VHFWIRQ ^636 : \=R SWIRQ ^8 \

(default = **disabled**) When enabled and a user arms or disarms a partition, the keypad emits a beep tone to confirm that the monitoring station received the arming or disarming report code.

Dial Tone Delay

VHFWIRQ ^636 : \=R SWIRQ ^: \

(default = **disabled**)

[7]	ON	If no dial tone is present, dialer hangs up after 32 secs.
[7]	OFF	If no dial tone is present, force dials after 3 secs.

If more time is required, insert a 4-second pause into the desired telephone number sequence (see *section*).

VDMP3 Voice Module

Attach support pin to EVOHD panel and VDMP3
Connect VDMP3 to EBUS and Dialer

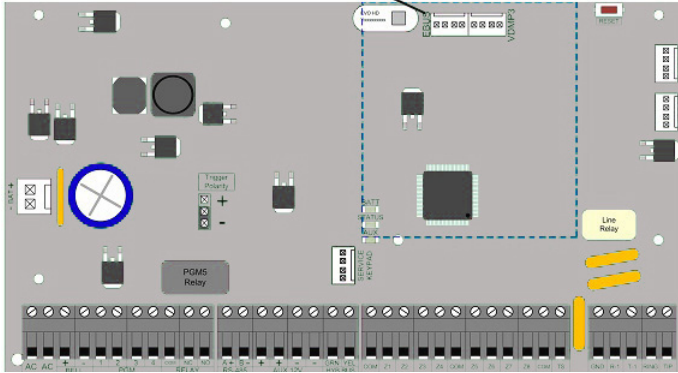
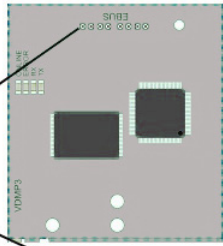

VDMP3 Installation Instructions

Step	English
1 Install	<ul style="list-style-type: none"> ◆ Power down the EVOHD control panel. ◆ Install the VDMP3 directly onto the EVOHD control panel's EBUS and DIALER connectors as shown in "VDMP3 Installation Instructions". ◆ Power up the EVOHD control panel.

Feature activation (PGMs)

Using the VDMP3, it is possible to activate the PGM utility keys or PGM groups that are programmed in the EVOHD panel. VDMP3 feature numbers do not necessarily correspond to EVOHD utility key numbers.

For example:

VDMP3 Feature	EVOHD Utility Key	VDMP3 Feature	EVOHD Utility Key
Feature 1 ON	Utility Key 1	Feature 5 ON	Utility Key 9
Feature 1 OFF	Utility Key 2	Feature 5 OFF	Utility Key 10
Feature 2 ON	Utility Key 3	Feature 6 ON	Utility Key 11
Feature 2 OFF	Utility Key 4	Feature 6 OFF	Utility Key 12
Feature 3 ON	Utility Key 5	Feature 7 ON	Utility Key 13
Feature 3 OFF	Utility Key 6	Feature 7 OFF	Utility Key 14
Feature 4 ON	Utility Key 7	Feature 8 ON	Utility Key 15
Feature 4 OFF	Utility Key 8	Feature 8 OFF	Utility Key 16

NOTE: If the utility key in the EVOHD panel is programmed with a timer, the VDMP3 will not recognize PGM deactivation when the set timer elapses. As a result, the VDMP3 may indicate that the PGM is ON when actually the timer has elapsed and the PGM is in fact OFF

VDMP3 Setup Instructions

Step	EVOHD section	English
1 Enable Functions	[3090]	Select the following options to enable voice reporting and arm/disarm function. [1] Voice module incoming call (default 1 and 2 ON) [2] Voice reporting [3] Report AC/battery trouble [4] Inhibit disarming on voice module
2 Telephone Numbers	[3091] to [3098]	Program up to 8 telephone numbers which will be called in sequence in the event of an alarm. Telephone numbers should be programmed in priority sequence as the VDMP3 will start with telephone number 1. For extra key functions, see <i>Special Telephone Number Keys</i> on page 30. [3091] Telephone number 1 [3095] Telephone number 5 [3092] Telephone number 2 [3096] Telephone number 6 [3093] Telephone number 3 [3097] Telephone number 7 [3094] Telephone number 4 [3098] Telephone number 8
3 Enable Numbers	[3133] to [3833]	Choose which telephone numbers will be enabled for each partition in your system. Options [1] to [8] represent telephone numbers 1 through 8. (Default: Telephone number 1 is enabled for all partitions.) [3133] Partition 1 [1] to [8] [3533] Partition 5 [1] to [8] [3233] Partition 2 [1] to [8] [3633] Partition 6 [1] to [8] [3333] Partition 3 [1] to [8] [3733] Partition 7 [1] to [8] [3433] Partition 4 [1] to [8] [3833] Partition 8 [1] to [8]
4 Answering Machine Override	[3052]	If the VDMP3 uses a telephone line that is connected to an answering machine or service, the Answering Machine Override must be programmed. The value programmed in section [3052] represents the delay period that the VDMP3 will wait between the first and second call. The user must call the VDMP3, hang up, and then call back within the value programmed in section [3052]. The module then overrides the answering machine or service by picking up the line on the first ring. 000 to 225 seconds (default 008) Note: Changing these values will also affect PC communication via BabyWare software.
5 Enable Features (PGM)	[3087]	Features in this section correspond to utility key PGMs in the EVOHD control panel. For more information, see Feature Activation (PGMs). Options [1] to [8] represent features 1 to 8 (default: OFF)
6 Message Delay	[3088]	After the VDMP3 dials a phone number, it waits the programmed delay period before sending the voice message. The value programmed in section [3088] represents the length of time the VDMP3 will wait before playing the message. 000 to 127 seconds (default 003)
7 Message Repetitions	[3089]	Set the number of times the VDMP3 will play the voice message. 000 to 008 repetitions (default 008)
8 Delay Before Next Number	[3054]	Set the delay before the VDMP3 attempts to dial the next number on the list. 000 to 255 seconds (default 020) Note: Changing these values will also affect regular reporting to monitoring station.
9 Ring Counter	[3051]	Set the number of rings the VDMP3 will wait before the call is answered. 000 to 008 rings (default 008) Note: Changing these values will also affect PC communication via BabyWare software.

Programmable Outputs

The control panel provides a maximum of 100 mA to PGM2 to PGM4. PGM1 is an open collector output and PGM5 is a 5A/28Vdc N.O./ N.C. relay output. Activating a PGM changes its state from open to closed or closed to open. Refer to *section* on page 5.

PGM Activation Event

The PGM Activation Event determines which event will activate the PGM. The Event Group specifies the event, the Feature Group identifies the source, and the Start # and End # sets the range within the Feature Group (see *PGM Programming Table* in the "EVOHD Programming Guide"). Enter the sections that correspond to the Event Group, Feature Group, Start # and End # of the desired PGM and enter the desired 3-digit number from the PGM Programming Table:

	Event Group	Feature Group	Start #	End #
PGM 1:	[0910]	[0911]	[0912]	[0913]
PGM 2:	[0920]	[0921]	[0922]	[0923]
PGM 3:	[0930]	[0931]	[0932]	[0933]
PGM 4:	[0940]	[0941]	[0942]	[0943]
PGM 5:	[0950]	[0951]	[0952]	[0953]

PGM Deactivation Option

Once the PGMs are activated, they can deactivate when another event occurs or after a period of time. Enter the section that corresponds to the desired PGM and enable or disable option [1] (default = **PGM Deactivation Event**):

PGM 1: [0919]			
PGM 2: [0929]	[1]	ON	PGM Timer
PGM 3: [0939]	[1]	OFF	PGM Deactivation Event
PGM 4: [0949]	[4]	ON	Normally Closed
PGM 5: [0959]	[4]	OFF	Normally Open

Flexible PGM Deactivation Option

The PGM Deactivation Option must be set to *PGM Timer* for this feature to function. The Flexible PGM Deactivation Option uses both the PGM Deactivation Event and the PGM Timer. When enabled, and if the PGM is activated, it will deactivate when **either** the PGM Deactivation Event occurs **or** the PGM Timer elapses, whichever happens first.

Enter the section corresponding to the PGM and enable option [3] (default = **disabled**):

PGM 1: [0919]	PGM 2: [0929]	PGM 3: [0939]
PGM 4: [0949]	PGM 5: [0959]	

PGM Deactivation Event

The PGM Deactivation Event determines which event will return the PGM to its original state. The Event Group specifies the event, the Feature Group identifies the source, and the Start # and End # determine the range within the Feature Group.

Enter the sections that correspond to the Event Group, Feature Group, Start # and End # of the desired PGM and enter the desired 3-digit number from the PGM Programming Table.

	Event Group	Feature Group	Start #	End #
PGM 1:	[0914]	[0915]	[0916]	[0917]
PGM 2:	[0924]	[0925]	[0926]	[0927]
PGM 3:	[0934]	[0935]	[0936]	[0937]
PGM 4:	[0944]	[0945]	[0946]	[0947]
PGM 5:	[0954]	[0955]	[0956]	[0957]

PGM Timer

When the PGM Deactivation Option is enabled, the PGM Timer determines how many seconds or minutes the PGM remains activated.

Enter the section that corresponds to the desired PGM and enter a value from 001 to 255 (default = **005**). The value entered is either in seconds or minutes as determined by the PGM Time Base Selection:

PGM 1: [0918]	PGM 2: [0928]	PGM 3: [0938]
PGM 4: [0948]	PGM 5: [0958]	

PGM Time Base Selection

The PGM Time Base Selection determines whether the PGM Timers are in minutes or seconds (default = **seconds**):

PGM 1: [0919]			
PGM 2: [0929]	[2]	ON	Minutes
PGM 3: [0939]	[2]	OFF	Seconds
PGM 4: [0949]			
PGM 5: [0959]			

PGM1 Becomes a 2-wire Smoke Detector Input*

VHFWIRQ ^6363 'RSWIRQ ^4 \

(default = **disabled**) When enabled, PGM1 acts as a zone input for two-wire smoke detectors. When programming Zone Numbering (see *section* on page 15), the control panel will recognize PGM1 as input number 255. Please refer to *section* on page 11 for connection information.

* **UL Note:** Not verified by UL.

PGM Test Mode

Entering sections [0901] to [0903] activates the corresponding PGM for 8 seconds to verify if the PGM is functioning as desired.

PGM 1: [0901]	PGM 2: [0902]	PGM 3: [0903]
PGM 4: [0904]	PGM 5: [0905]	

PGM Initial Status

Use this option to set the initial state for the PGM.

PGM 1: [0919]			
PGM 2: [0929]	[4]	ON	Normally Closed
PGM 3: [0939]	[4]	OFF	Normally Open
PGM 4: [0949]			
PGM 5: [0959]			

System Settings and Commands

Hardware Reset

A Hardware Reset sets sections [0001] to [3991] to default. Only the Panel ID, PC Password, PC Telephone Number and Event Buffer are not reset. The Installer Code Lock prevents Hardware Reset.

1. Make sure the Installer Code Lock is disabled
2. Press Reset button for 5 seconds (STATUS blinks) then release and press again for 1 second.
3. The panel will be reset to defaults

Software Reset

Performing a software reset will set certain parameters to default values or program certain sections with a set of pre-defined values. To reset:

1. Enter *Panel Programming Mode* (see *section*).
2. Enter section [4049] to unlock software reset.
3. Enter the 4-digit [SECTION] of the software reset you wish to perform.
4. For every other section your want to reset, you will have to unlock software reset.

[4040]	Resets the programmable sections from [0001] to [3991] to default (even if Installer Code Lock is enabled) except: Event Buffer, Panel ID, PC Password, PC Telephone Number and Zone, Door, Partition and User Labels (see <i>section</i> on page 40).
[4041]	Resets the System Master Code to 123456.
[4042]	Resets all Zone Programming sections from [0001] to [0196], [0201] to [0296] and [0961] to [0984] to default.
[4043]	Resets the Access Control sections, except Door Labels (see <i>section</i> on page 38), from [2201] to [2712] to default.
[4044]	Resets all User Access Code Programming sections from [1001] to [1999] and [2001] to [2199] to default. User Labels (see <i>section</i> on page 40) will not be reset.
[4045]	Resets all control panel settings from [3020] to [3043] and from [3900] to [3991] and all the Dialer sections from [3051] to [3081].
[4046]	Resets all Partition Settings, except Partition Labels (see <i>section</i> on page 38), from [3101] to [3831] to default.
[4047]	Resets Keyswitch Programming sections from [0501] to [0832] and all Programmable Outputs sections from [0901] to [0939] to default.
[4048]	Entering this section resets the User Labels from the User Access Codes, the Zone Labels from [0301] to [0396], Door Labels from [2301] to [2332], Partition Labels [3100], [3200], [3300], [3400], [3500], [3600], [3700] and [3800] to default.
[4049]	Entering this section will unlock software reset for sections [4040] to [4048].

WARNING: Do not remove power from the control panel.

Installer Code Lock

VHFWIRQ ^6334 ` (default = 000) Enter 147 into section [3001] to lock all programming. When 147 is programmed, performing a hardware reset as described in *section* will not affect the current panel settings. To remove the Installer Lock, enter 000 into section [3001].

Daylight Savings Time

VHFWIRQ ^6363 '=RSWIRQ ^6 ` (default = **enabled**) When enabled, the control panel adjusts the system's clock (time) for daylight saving changes.

Daylight Savings Time Schedule

VHFWIRQ ^6355 ` (default = 18)

Select the schedule followed for the Daylight Savings Time adjustment.

00	Canada/United States/Mexico/St-Johns/Bahamas/Turks and Caicos	01	Cuba
02	Brazil	03	Chile
04	Falkland Islands	05	Paraguay
06	European Union/United Kingdom/Greenland	07	Russia and surrounding countries
08	South Australia/Victoria/Australian Capital Territory/New South Wales	09	Tasmania/Lord Howe Island
10	New-Zealand/Chatham	11	Tonga
12	Iraq/Syria	13	Israel (TBC)
14	Lebanon/Kirgizstan	15	Palestine
16	Egypt	17	Namibia
18	Canada/United States 2007 (default)	19	New Zealand

Digiplex bus Speed

VHFWIRQ ^6363 '=RSWIRQ ^; `

In large installations, set the speed to High. If you are experiencing communication troubles, set the speed to Normal or install a Hub (HUB2 or HUB4D). The control panel will restart when a change is made

[8]	ON	High Speed
[8]	OFF	Normal Speed (default)

NOTE: Please note that when the Digiplex bus speed is changed the following will occur and is considered normal operation:

- The message COMM. TROUBLE CALL SERVICE will be displayed on keypads connected to the Digiplex bus.
- The AC and STATUS LEDs will begin to alternately flash and all operations on the system will be suspended for approximately one minute while the system reconfigures.

Transmit Zone Status on Serial Port

VHFWIRQ ^6368 '=RSWIRQ ^: `

When enabled, the control panel will transmit zone status information through the serial port. Use this when there are devices or software connected to the serial port like BabyWare.

Partitioning

VHFWIRQ ^6364 '=RSWIRQV ^4 `WR ^; `

(default = **partition 1 enabled**) The control panel can provide up to eight completely independent partitions. Most features and options can be independently set for each partition. All zones, keyswitch zones, user codes and system modules are assigned to specific partitions.

[1]	Partition 1	[3]	Partition 3	[5]	Partition 5	[7]	Partition 7
[2]	Partition 2	[4]	Partition 4	[6]	Partition 6	[8]	Partition 8

Panel Partition Assignment

VHFWIRQ ^6353 `

(default = 00) The control panel will report system events as originating from one or all enabled partitions. The System Troubles can only be viewed through the partitions enabled in this section. Enter a 2-digit decimal number from 01 to 08 which represent partitions 1 to 8. Enter 00 to disable this feature.

Shabbat Feature

VHFWIRQ ^6363 '=RSWIRQ ^7 `

(default = **disabled**) When enabled, addressable detectors and keypads in the system no longer display system status through the LCD and/or LEDs between

noon Friday and midnight Saturday. Normal operation is re-instated Sunday at 12:00:01a.m. A user can access all the usual commands and features during the Shabbat period by pressing a key or by entering their access code (depending on how Confidential Mode is configured in the keypad). When no actions have occurred for two minutes, the Shabbat feature will re-activate. During the Shabbat period:

- the LCD keypads only display the date and time
- the backlight is disabled
- the LED indicators on modules are disabled

Installer Function Keys

Press and hold the **[0]** key and key in the **[INSTALLER CODE]** to access the installer functions and then:

For LCD keypads: Press the key indicated in the list below that corresponds to the function you wish to activate.

[STAY]	TEST REPORT: Sends the <i>Test Report</i> report code programmed in section [3902] to the monitoring station.
[FORCE]	CALL BABYWARE: Dials the PC telephone number programmed in section [3010] to communicate using BabyWare.
[ARM]	ANSWER BABYWARE: Forces the control panel to answer a call made by the monitoring station that is using BabyWare.
[DISARM]	CANCEL COMMUNICATION: Cancels all communication with the monitoring station or BabyWare until the next reportable event.
[MEM]	INSTALLER TEST MODE: Perform walk tests where the bell or siren squawks once when a zone opens and twice when it closes. Press [MEM] again to exit. Partitions cannot be armed if the Installer Test Mode is enabled.
[trbl]	START MODULE SCAN: Verifies the status of modules on the Digiplex bus. The LCD Keypads display the serial number of each module connected to the Digiplex bus.
[ACC]	START VOLTMETER READING (K641/K641R/K641LX/K641+/TM50): Verifies if the Digiplex bus is supplying enough power at the keypad's location.

Module Reset

VHFWIRQ ^7334`

To reset a module connected to the Digiplex bus to its default values, key in the module's serial number into section **[4001]**.

Locate Module

VHFWIRQ ^7335`

To locate a specific module on the Digiplex bus, key in the module's serial number into section **[4002]**. The LED on the module flashes until the serial number is entered or the module's tamper or unlocate switch is pressed.

Module Programming

VHFWIRQ ^7336`

To program a module, enter section **[4003]** to enter *Module Programming Mode* (see *section* on page 13), and enter the module's serial number. To exit, press the **[CLEAR]** key until Normal Mode is displayed.

Module and Label Broadcast

The EVOHD panel will now automatically broadcast its system labels to all modules when a new keypad is connected to the system.

VHFWIRQ ^7337`

Module Broadcast

To copy the contents of the programming sections from one module to another, enter the serial number of the source module in section **[4004]**, enter the serial numbers of all the destination modules and press **[ACC]** or the center action key (**Start**).

Label Broadcast

Copy the User Labels, Zone Labels (sections **[0301]** to **[0396]**), the Door Labels (sections **[2301]** to **[2332]**) and the Partition Labels (sections **[3100]**, **[3200]**,

[3300], **[3400]**, **[3500]**, **[3600]**, **[3700]** and **[3800]**) to all the modules in the system that support these labels. To transmit the labels, in section **[4004]**, enter the control panel's serial number. From the Destination screen, do not enter a serial number and press **[ACC]** if using an LCD keypad.

NOTE: The Module and Label Broadcast feature will only work when a module is broadcasting its data to a module or to modules of the same type and model number.

System Date & Time

The System Date and Time is programmed through the User Menu.

Quick Module Scanning

VHFWIRQ ^7338`

After entering the section, the control panel will scan all addresses assigned to modules. If any missing modules are detected (i.e. detector removed from the Digiplex bus), the control panel will erase the module's serial number, removing the module from the control panel's memory.

Module Scanning

VHFWIRQ ^7339`

After entering the section, the control panel will scan all addresses on the Digiplex bus. If any missing modules are detected (i.e. detector removed from the Digiplex bus), the control panel will erase the module's serial number, removing the module from the control panel's memory. If new modules are detected, the serial number will be entered in the control panel's memory.

Serial Number Viewing

VHFWIRQ ^7333`

Enter section **[4000]** to view the serial number of the control panel and all the modules on the Digiplex bus. The firmware version of some modules will be displayed as well (e.g. (XXXXXXXX) VXX.XX).

For LCD Keypads: The keypad will display the control panel's serial number. Use the **[▲]** and **[▼]** keys to scroll.

Power Save Mode

VHFWIRQ ^6366`=RSWIRQV ^7`

(default = **enabled**) When enabled and the control panel is running on the backup battery, the control panel can set all keypads into Power Save Mode. The keypad's backlight and LEDs are disabled until a key is pressed, an alarm occurs or an Entry Delay is triggered.

Auto Trouble Shutdown

VHFWIRQ ^6354`

(default = **00**) If a trouble occurs more than the number programmed, the control panel stops reporting the trouble. Enter a value between 01 and 15, (00 = disabled). Each trouble has its own counter that is reset at midnight.

No AC Fail Display

VHFWIRQ ^6363`=RSWIRQ ^9`

(default = **disabled**) When enabled, the control panel will not display the AC Failure as a trouble. When an AC Failure occurs with this option enabled:

- the AC LED will extinguish
- the AC Failure report code will be reported.
- the trouble will not appear in the Trouble Display
- the keypad will not beep to indicate the trouble

Multiple Action Feature

VHFWIRQ ^6366`=RSWIRQ ^4`

(default = **disabled**) When enabled, users will remain in the User Menu after entering their access code. With option **[1]** off, the control panel will exit the User Menu after every action.

System Labels

The existing label displayed on the LCD screen can be modified to suit the installation's needs. Each label contains a maximum of 16 characters. To re-program the System Label, enter the desired section and use *Table 8*, *Table 10* and *Table 9* (page 38) to modify the label. For other languages, refer to *Table 11* to *Table 15* on page 39.

Zone Labels: Sections [0301] to [0396] represent Zones 01 to 96.
Door Labels: Sections [2301] to [2332] represent Doors 01 to 32.

Partition Labels:			
Partition 1: [3100]	Partition 3: [3300]	Partition 5: [3500]	Partition 7: [3700]
Partition 2: [3200]	Partition 4: [3400]	Partition 6: [3600]	Partition 8: [3800]

Table 8: Keys

Press	Feature	Description
[STAY]	Insert Space	Inserts a blank space in the cursor's position
[FORCE]	Delete	Deletes the character or blank space found at the cursor's position
[ARM]	Delete Until the End	Deletes all characters and spaces to the right of the cursor and at the cursor's position
[DISARM]	Numeric or Alphanumeric	Switches from numeric keys to alphanumeric keys and vice versa (see Table 9)
[BYP]	Lower or Upper Case	Switches the case setting from lower to upper case and vice versa
[MEM]	Special Characters	The cursor will turn into a flashing black square. Enter the 3-digit number that represents the desired symbol (see Table 10 on page 38, Table 14 on page 39 and Table 15 on page 39).

Table 9: Numeric and Alphanumeric keys

Key	Numeric	Alphanumeric		
	Press key one time	Press key one time	Press key two times	Press key three times
[0]	0	---	---	---
[1]	1	A	B	C
[2]	2	D	E	F
[3]	3	G	H	I
[4]	4	J	K	L
[5]	5	M	N	O
[6]	6	P	Q	R
[7]	7	S	T	U
[8]	8	V	W	X
[9]	9	Y	Z	

Table 10: Special Characters Catalogue

032	0	@	P	,	1	0	E	a	S	ø	·	α	ρ
033	!	1	A	Q	9	1	U	ä	†	±	∴	∞	∑
034	¨	2	B	R	b	r	ú	ë	ì	ÿ	ø	∞	∑
035	#	3	C	S	c	s	ü	ë	í	↑	β	¼	∞
036	\$	4	D	T	d	t	û	ë	ï	↓	ç	½	∞
037	%	5	E	U	e	u	ü	ë	î	↔	⊗	¾	∞
038	&	6	F	V	f	v	ü	ë	ï	↔	⊗	¾	∞
039	'	7	G	W	g	w	ö	ë	ï	↔	⊗	¾	∞
040	<	8	H	X	h	x	ò	ä	ñ	↔	⊗	¾	∞
041	>	9	I	Y	i	y	ó	ä	ñ	↔	⊗	¾	∞
042	*	:	J	Z	j	z	o	ä	ñ	↔	⊗	¾	∞
043	+	;	K	L	k	l	ö	ä	ñ	↔	⊗	¾	∞
044	,	<	L	\	I		ó	ä	ñ	↔	⊗	¾	∞
045	-	=	M	O	m	o	ö	ä	ñ	↔	⊗	¾	∞
046	.	>	N	^	n	^	ö	ä	ñ	↔	⊗	¾	∞
047	/	?	O	_	o	_	ó	ä	ñ	↔	⊗	¾	∞

Table 11: Hebrew Keypad Letter Assignment

Key	Press key once	Press key twice	Press key three times
[1]	א	ב	ג
[2]	ד	ה	ו
[3]	ז	ח	ט
[4]	י	כ	ל
[5]	מ	נ	ס
[6]	ע	פ	צ
[7]	ק	ר	ש
[8]	ת		
[9]	ך	שׁ	תׁ

Table 12: Russian Keypad Letter Assignment

Key	Press key once	Press key twice	Press key three times	Press key four times
[1]	А	Б	В	Г
[2]	Д	Е	Ё	Ж
[3]	З	И	Й	К
[4]	Л	М	Н	О
[5]	П	Р	С	Т
[6]	У	Ф	Х	Ц
[7]	Ч	Ш	Щ	Ъ
[8]	Ы	Ь	Э	Ю
[9]	Я			

Table 13: Greek Keypad Assignment

Key	Press key once	Press key twice	Press key three times
[1]	C	D	I
[2]	F	G	\
[3]	J	S	K
[4]	M	N	O
[5]	P	Q	Q
[6]	R	T	U
[7]	V	W	H
[8]	E	[Y

Table 14: Hebrew Special Characters Catalogue

032	048	064	080	096	112	160	176	192	208	224	240
033	049	065	081	097	113	161	177	193	209	225	241
034	050	066	082	098	114	162	178	194	210	226	242
035	051	067	083	099	115	163	179	195	211	227	243
036	052	068	084	100	116	164	180	196	212	228	244
037	053	069	085	101	117	165	181	197	213	229	245
038	054	070	086	102	118	166	182	198	214	230	246
039	055	071	087	103	119	167	183	199	215	231	247
040	056	072	088	104	120	168	184	200	216	232	248
041	057	073	089	105	121	169	185	201	217	233	249
042	058	074	090	106	122	170	186	202	218	234	250
043	059	075	091	107	123	171	187	203	219	235	251
044	060	076	092	108	124	172	188	204	220	236	252
045	061	077	093	109	125	173	189	205	221	237	253
046	062	078	094	110	126	174	190	206	222	238	254
047	063	079	095	111	127	175	191	207	223	239	255

Table 16: Greek Special Characters Catalogue

016	032	048	064	080	096	112	128	144	160	176	192	208	224	240
017	033	049	065	081	097	113	129	145	161	177	193	209	225	241
018	034	050	066	082	098	114	130	146	162	178	194	210	226	242
019	035	051	067	083	099	115	131	147	163	179	195	211	227	243
020	036	052	068	084	100	116	132	148	164	180	196	212	228	244
021	037	053	069	085	101	117	133	149	165	181	197	213	229	245
022	038	054	070	086	102	118	134	150	166	182	198	214	230	246
023	039	055	071	087	103	119	135	151	167	183	199	215	231	247
024	040	056	072	088	104	120	136	152	168	184	200	216	232	248
025	041	057	073	089	105	121	137	153	169	185	201	217	233	249
026	042	058	074	090	106	122	138	154	170	186	202	218	234	250
027	043	059	075	091	107	123	139	155	171	187	203	219	235	251
028	044	060	076	092	108	124	140	156	172	188	204	220	236	252
029	045	061	077	093	109	125	141	157	173	189	205	221	237	253
030	046	062	078	094	110	126	142	158	174	190	206	222	238	254
031	047	063	079	095	111	127	143	159	175	191	207	223	239	255

Table 15: Russian Special Characters Catalogue

032	048	064	080	096	112	128	144	160	176	192	208	224	240
033	049	065	081	097	113	129	145	161	177	193	209	225	241
034	050	066	082	098	114	130	146	162	178	194	210	226	242
035	051	067	083	099	115	131	147	163	179	195	211	227	243
036	052	068	084	100	116	132	148	164	180	196	212	228	244
037	053	069	085	101	117	133	149	165	181	197	213	229	245
038	054	070	086	102	118	134	150	166	182	198	214	230	246
039	055	071	087	103	119	135	151	167	183	199	215	231	247
040	056	072	088	104	120	136	152	168	184	200	216	232	248
041	057	073	089	105	121	137	153	169	185	201	217	233	249
042	058	074	090	106	122	138	154	170	186	202	218	234	250
043	059	075	091	107	123	139	155	171	187	203	219	235	251
044	060	076	092	108	124	140	156	172	188	204	220	236	252
045	061	077	093	109	125	141	157	173	189	205	221	237	253
046	062	078	094	110	126	142	158	174	190	206	222	238	254
047	063	079	095	111	127	143	159	175	191	207	223	239	255

Access Codes

Installer Code

VHFWIRQ ^4333`

(default = **000000**) The Installer Code is six digits in length where each digit can be any value from 0 to 9. To change the Installer Code:

1. Press and hold **[0]**
2. Enter **[INSTALLER CODE]**
3. Key in **[1000]**
4. Enter new 6-digit **[INSTALLER CODE]**

! The Installer Code can program the User Code Options and the Partition Assignment, but cannot program the personal identification numbers.

Access Code Length

VHFWIRQ ^6366`=RSWIRQV ^5`DQG ^6`

Access codes can be 1 to 6 digits in length if flexible user access code is enabled. When programming access codes with less than 6 digits, press the **[ENTER]** key after entering the last digit. The control panel automatically removes the last 2 digits of the user access code if the length is changed from 6 digits to 4 digits. However, if the user access code length is changed from 4 digits to 6 digits, the control panel adds 2 digits to the end by using the first 2 digits.

[2]	[3]	
OFF	OFF	4-digit User Access Code (default)
OFF	ON	6-digit User Access Code
ON	ON	Flexible User Access Code

System Master Code

VHFWIRQ ^4334`

(default = **123456**) The Installer Code can change the User Code Options, Partition Assignment and Access Control Options, but cannot change the personal identification number (PIN). Each digit in the System Master Code can be any value from 0 to 9. To reset the System Master Code, refer to *section* on page 36. With the System Master Code, a user can use any of the available arming methods with access to all partitions and can program all user access codes, User Options, Partition Assignments and Access Control Options.

The minimum number of variations of PIN codes for each user is 1,000,000 when using a 6-digit user code in order to comply with EN 50131-3 Grade 3 compliancy.

Programming Access Codes

VHFWIRQV ^4335`WR ^4<<<`

(default = **all options are off except bypass**) The control panel supports 998 user access codes. In sections **[1002]** to **[1999]**, the Installer Code can program the User Code Options, Partition Assignment and Access Control Options, but cannot program the personal identification numbers (PIN). To program the PINs, refer the users to the "System Manager's Manual". The System Master Code or a user with the Master feature enabled can program the User Code Options, Partition Assignment, Access Control Options and User Labels using a different method of programming.

NOTE: If no partition assignment is selected, the user access code will **only** be able to activate PGMs.

To program user labels, refer to the "LCD Keypad System Manager's Manual".

User Options

VHFWIRQV ^4335`WR ^4<<<`=XVHU RSWIRQV VFUHHQ/RSWIRQV ^4`WR ^;`

The User Options define how each user access code can arm or disarm the partitions. All users can Regular arm their assigned partitions, but only those with the Arm Only option disabled can disarm an assigned partition.

NOTE: Enable or disable the options as required for each user access code as shown in *Figure 18*.

Figure 18: Programming User Access Codes

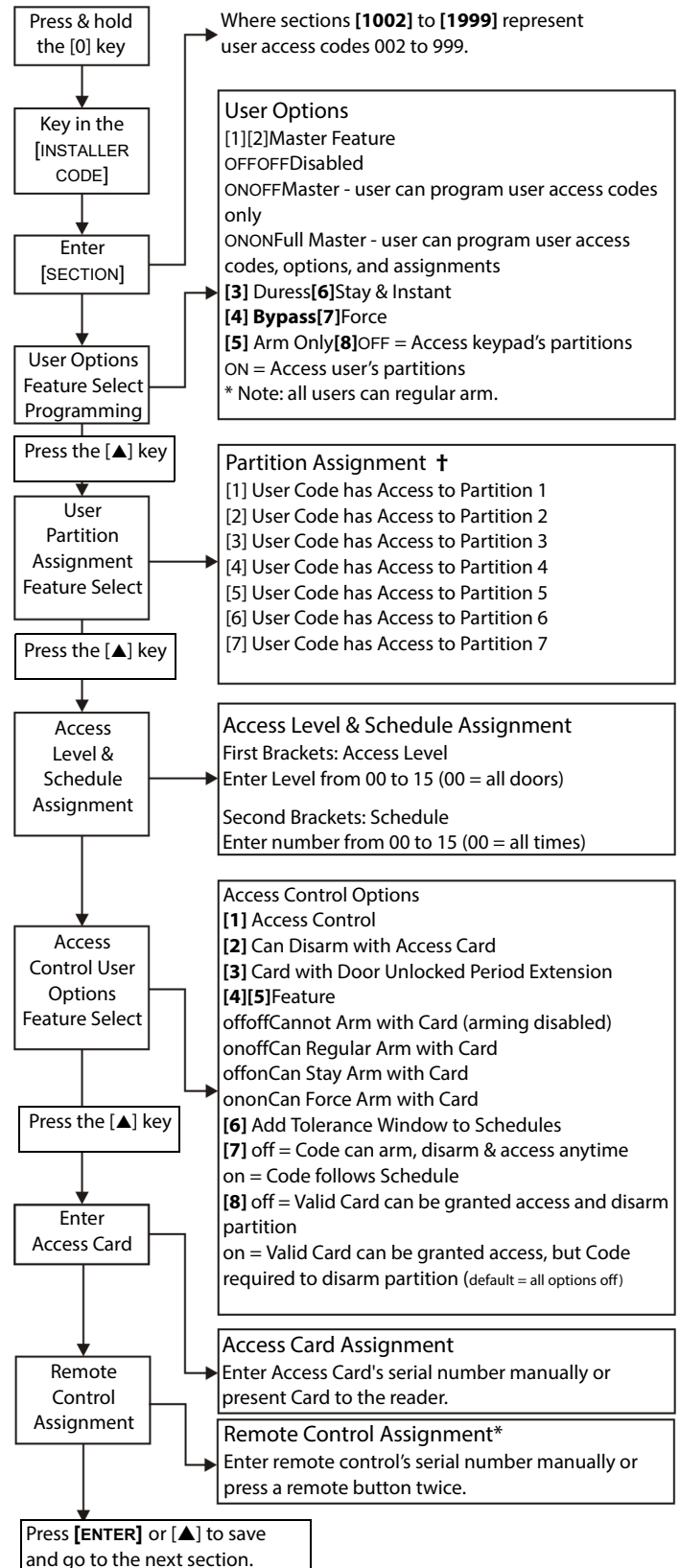

† The default setting depends on the programming user's assigned partitions. For example, when a user (with master feature) that is assigned to partitions 1 and 2 programs a user code, partitions 1 and 2 will be the default setting for the new user.

* Remote controls can also be assigned using a Master Code.

Partition Assignment

VHFWIRQV ^4335\WR ^4<<< \=DVVLTQ DUHD VFUHHQ/RSWIRQV ^4\WR ^;`
 Each of the 998 user access codes can be assigned to one or more partitions. Users can only arm, disarm and view the status of the partitions assigned to their user access codes. Select one or more of the partitions for each user access code as shown in *Figure 18* on page 40.

NOTE: If no partition assignment is selected, the user access code will **only** be able to activate PGMs. The default setting depends on the programming user's assigned partitions. For example, when a user (with master feature) that is assigned to partitions 1 and 2 programs a user code, partitions 1 and 2 will be the default setting for the new user.

[1]	[2]		
OFF	OFF	Master disabled	User cannot create or modify other user access codes.
ON	OFF	Master enabled	User can create new user access codes with default options only, can program PINs and User Labels.
ON	ON	Full Master enabled	User can create and modify user access codes and program the User Options, Partition Assignment (can assign only the partitions the Master Code has access to), Access Control features, PINs and User Labels.
[3]		Duress	A Duress enabled user access code can arm or disarm the partition and can immediately transmit a silent alarm to the monitoring station.
[4]		Bypass	User can program bypass entries.
[5]		Arm Only	User can arm assigned partitions, but cannot disarm.
[6]		Stay or Instant Arm	User can Stay arm or Instant arm assigned partitions.
[7]		Force Arm	User can Force arm assigned partitions
[8]		User Menu Access	Option [8] ON = User can access all its assigned partitions, regardless of the keypad's partition assignment. Option [8] OFF = User can only access the partitions assigned to both itself and the keypad.

Access Control

VHFWIRQV ^4335\WR ^4<<<`
 In addition to the user access code options, the following options can be programmed when Access Control is enabled: Access Level, Schedule, Access Options and Access Card. For details on Access Control, see page 42.

NOTE: The System Master Code and user access codes with the Full Master feature enabled can also program the Access Level, Schedule, Access User Options, and Access Card using another method for programming.

WARNING: The System Master Code has access to all doors all the time. Only the card's serial number and the choice of arming method can be changed. If the other options are changed, the System Master Code will revert to its original programming.

Access Level Assignment

VHFWIRQV ^4335\WR ^4<<< \=OHYHO . VFKHGXOH VFUHHQ
 User access codes can only open the doors included in their assigned Access Level (see *section* on page 42). In the first set of brackets, enter the two-digit Access Level number (00 to 15, 00 = unrestricted) to be assigned to that user access code.

Schedule Assignment

VHFWIRQV ^4335\WR ^4<<< \=OHYHO . VFKHGXOH VFUHHQ
 Schedules determine the hours, days and holidays that user access codes can open the doors in their assigned Access Level (see *section*). In the second set of brackets, enter the two-digit Primary Schedule number (00 to 15, 00 = unrestricted) to be assigned to that user access code.

Access Control Options

VHFWIRQV ^4335\WR ^4<<< \=DFFHV VRSWIRQ VFUHHQ/RSWIRQV ^4\WR ^;`
 The Access Control Options define how each Access Card can arm or disarm the partitions. To arm the partition(s) assigned to the door, a valid card is presented

to the reader twice within approximately 5 seconds while the door remains closed. For the card to be valid, it must be presented during its assigned Schedule, within its assigned Access Level and be assigned to the keypad's assigned partitions depending on the Door Access Mode (see *section* on page 43). Enable or disable the options as required for each Access Card as shown in *Figure 18* on page 40.

NOTE: A user that is not assigned to any partition, but has the access control user option [1] enabled ("Access Control"), can now gain access to an access control door by entering a code # (PIN) and then pressing the [ACC] keypad button.

[1]	Access Control	ON = User's Access Control feature is enabled and user has access when the control panel's Access Control feature is enabled. OFF = User's Access Control feature is disabled, but the user access code remains unaffected. This can be used to disable a lost or stolen card without deleting the user access code.
[2]	Card can Disarm	Card can unlock Door and disarm assigned partitions. User Option [5]: Arm Only must be disabled for this feature to function.
[3]	Card with Extended Unlocked Period	Card uses the Door Unlocked Period Extension feature (see ACM12's "Reference & Installation Manual").
[4]	[5]	
OFF	OFF	Arming Disabled Cannot arm partitions
ON	OFF	Regular Arm Card can Regular arm
OFF	ON	Stay Arm Card can Stay arm
ON	ON	Force Arm Card can Force arm
[6]	Add Tolerance Windows to Schedules	Card and Code use the Schedule Tolerance Windows (see <i>page 30</i> and <i>page 42</i>).
[7]	Code follows Schedule	ON = Code is only valid during assigned Schedule (see <i>section</i>). OFF = Code is valid at all times.
[8]	Card to Unlock and Code to Disarm	ON = A door contact must be installed on the Door, the Door must be assigned to a zone (<i>section</i>) and the zone defined as an Entry Delay. A valid Card can unlock the Door, but cannot disarm the partition. If the partition is armed, the Entry Delay is triggered and a user access code must be entered to disarm the area. User Option [5]: Arm Only and Access Control Option [2]: Card can Disarm must be disabled for this feature to function. OFF = A valid Card can unlock the Door and disarm the partition.

Access Card Assignment

VHFWIRQV ^4335\WR ^4<<< \=DFFHV VFDUG VFUHHQ
 The Access Card is activated by assigning its serial number to the user access code. EVOHD supports 26-bit Wiegand proximity cards and readers (recommended: R910 reader and R700 Series cards). Enter the serial number manually or present the Access Card to the keypad's reader and its serial number will register automatically.

Access Control: System Features

For details on connecting Access Control devices, refer to the “Digiplex Access Control Module Reference & Installation Manual”.

Figure 19: Typical Access Control Installation

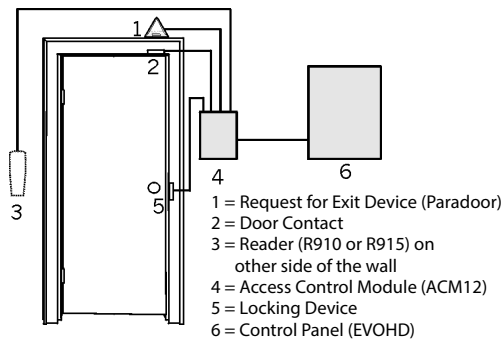

Persons authorized to access the protected area are issued cards assigned to user access codes programmed with an Access Level (see *section*) and a Schedule (see *section*). The control panel determines whether or not to unlock the door depending on the card’s schedule and access.

Common Access Control Terms

Access Alarm: A warning generated by the reader if an Access Door is open past the programmed time or if it was opened without the proper signal. This event is logged in the Event Buffer, but cannot be reported.

Access Card: A tag assigned to a user access code used to identify the user to the Access Control system.

Access Denied: The system preventing access through an Access Door.

Access Granted: The system granting access through a protected door.

Burglar Alarm: A warning sent to the control panel if an armed zone in the EVOHD security system has been breached. This event is logged in the Event Buffer and can be reported to a monitoring station.

Door Left Open: Each Access Door is programmed with a period of time it is allowed to stay open. An Access Alarm will be triggered after that period.

Forced Door: An Access Door was opened without an “Access Granted” or “Request for Exit” signal, a silent or audible Access Alarm can be triggered.

Reader: An Access Control device (R910) located near an Access Door that sends the information from an Access Card to the control panel.

Request for Exit: When a REX device (Paradoo 460) detects movement, it sends a request-for-exit signal to the panel.

Valid Card: An Access Card presented to a reader during its assigned Schedule and within its assigned Access Level.

Programming Overview

The following is the **MINIMUM** required to program Access Control:

1. Enable Access Control in section [3038] option [1].
2. Assign the Doors in sections [2201] to [2232].
3. Create the Access Levels in sections [2601] to [2615].
4. Create the Schedules in sections [2401] to [2432].
5. Set the Holidays in sections [2701] to [2712].
6. Program user access codes (see *section* on page 40).
7. Program the Access Control Modules.

Enable Access Control

VHFWIRQ ^636; 'R=RSWIRQ ^4'

(default = **disabled**) Enable to activate Access Control.

Door Numbering

VHFWIRQV ^5534 'WR ^5565'

Each door monitored and controlled requires an Access Control Module (ACM12) or an access keypad. The keypad or module is assigned to the door in sections [2201] to [2232]. EVOHD supports up to 32 Doors.

Access Levels

VHFWIRQV ^5934 'WR ^5948'

Access Levels determine which Doors a user can access. Each Access Level is a combination of the Doors from sections [2201] to [2232]. They are assigned to the users through their user access codes (refer to the “System Manager’s Manual”). Sections contains four screens representing the 32 Doors. Level 00 allows the user to access all.

Level 01: [2601]	01 to 08	09 to 16	17 to 24	25 to 32
to				
Level 15: [2615]	01 to 08	09 to 16	17 to 24	25 to 32

Access Schedules

VHFWIRQV ^5734 'WR ^5765'

Schedules consist of two programmable time periods called Interval A and B. Enter the Start Time and the End Time in the first and second screen. Select the days in which it is valid in the third screen. Option [8] represents the programmed holidays. If enabled, users have access between the Start Time and End Time during the holidays. An Interval cannot cross into another day. Schedules are assigned to the users through their user access codes (refer to the “System Manager’s Manual”). Primary Schedules 001 to 015 are programmed in sections [2401] to [2415] respectively. Secondary Schedules 016 to 032 are programmed in sections [2416] to [2432] respectively. Schedule 000 allows the user access at all times. Primary Schedules can be assigned to user access codes. Secondary Schedules are Backup Schedules.

Section		Start Time	End Time	Days
Schedule 001: [2401] to Schedule 032: [2432]	A:	set as per 24hr. clock	set as per 24hr. clock	[1] = Sunday (S) [2] = Monday (M) [3] = Tuesday (T) [4] = Wednesday (W) [5] = Thursday (T) [6] = Friday (F) [7] = Saturday (S) [8] = Holidays (H)
	B:	set as per 24hr. clock	set as per 24hr. clock	

Backup Schedules

VHFWIRQ ^5834 'WR ^5865'

When an Access Card or user access code is used at an Access Door, the control panel verifies whether it was used during its assigned Primary Schedule. If there are linked schedules, it will verify them. The control panel will verify up to 8 linked Schedules. Each Schedule from 001 to 032 can be linked to another Schedule in sections [2501] to [2532]. In each section enter the 3-digit Schedule number to link it.

Holiday Programming

VHFWIRQV ^5:34 'WR ^5:45'

Holiday Programming identifies holidays. Each section from [2701] to [2712] represents a month. Each section includes four groups of five to eight options that represent the days of the month. Enable the options representing the holidays.

Schedule Tolerance Window

VHFWIRQ ^636<'

User access codes with ‘Add Tolerance Windows to Schedules’ enabled have the number of minutes programmed in [3039] added before and after their Schedule. Enter any value between 001 and 255 (default = 000) to determine Schedule Tolerance Window in minutes.

Figure 20: Example of a Schedule Tolerance Window

User's assigned Schedule is 9a.m. to 5p.m. When 'Add Tolerance Windows to Schedules' is enabled for the user, the user has access from 8a.m. to 6p.m.

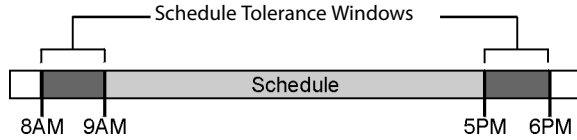

NOTE: The Schedule Tolerance Window applies to Access Schedules only (see section on page 42), and not to the Arming and Disarming Report Schedules (see section on page 30).

Door Access Mode

VHFWIRQ ^5584 \WR ^55 ; 5 '=RSWIRQ ^4 \

Access Door and user can be assigned to one or more partitions in the security system. Actions performed by the user will be directly linked to the partition(s) assigned to that door. Doors 01 to 32 are programmed in sections [2251] to [2282] respectively.

[1]	ON	"OR" Access Door The Access Door grants access or permits arming or disarming to users assigned to at least one of the door's partitions. An "OR" door will arm or disarm only the partitions that it has in common with the users.
[1]	OFF	"AND" Access Door The Access Door grants access or permits arming only to users assigned to all the door's assigned partitions.

Code Access

VHFWIRQ ^5584 \WR ^55 ; 5 '=RSWIRQ ^5 \

Code Access can allow access to an Access Door by entering a valid user access code and pressing the [ACC] key on a K641 LCD Keypad instead of using the Access Card. The control panel will verify its assigned Access Level and Schedule. Doors 01 to 32 are programmed in sections [2251] to [2282] respectively.

[2]	ON	[Acc] key enabled
[2]	OFF	Access with Card only

Card and Code Access

VHFWIRQ ^5584 \WR ^55 ; 5 '=RSWIRQ ^6 \

The Access Door can be programmed to require a user to present a valid Access Card and then enter the user's valid code on a R915 that is connected to an Access Control Module (ACM12). The R915 and the Access Control Module must be correctly configured. Please refer to the R915 "Installation and Operating Instructions", and to the Access Control Module "Reference & Installation Manual" for instructions. Doors 01 to 32 are programmed in sections [2251] to [2282] respectively.

[3]	ON	Access Card AND User Access Code required
[3]	OFF	Access Card OR User Access Code

NOTE: When option [3] is enabled, the Access Card must be presented **before** the user access code is entered.

Skip Exit Delay When Arming With Access Card

VHFWIRQ ^636 ; '=RSWIRQ ^9 \

(default = **disabled**) When arming with an Access Card, the system can arm with or without starting the Exit Delay.

[6]	ON	The Exit Delay is cancelled
[6]	OFF	The Exit Delay is triggered

Restrict Arming on Door

VHFWIRQ ^5584 \WR ^55 ; 5 '=RSWIRQ ^7 \

With option [4] ON, the control panel can prevent an Access Card from arming the partition(s) assigned to the door even if the Access Card is programmed to permit arming.

Restrict Disarming on Door

VHFWIRQ ^5584 \WR ^55 ; 5 '=RSWIRQ ^8 \

With option [5] ON, the control panel can prevent an Access Card from disarming the partition(s) assigned to the door even if the Access Card is programmed to permit disarming.

Door Access During Clock Loss

VHFWIRQ ^636 ; '=RSWIRQ ^ ; \

(default = **disabled**) If the system registers a Clock Loss Trouble, the control panel will no longer recognize the Schedules until the clock is reset. Enable or disable the option as required:

Option		Until the Clock is reset, access can be granted to:
[8]	ON	The System Master or User Access Code with Master feature or Schedule 00 (00 = all times) enabled
[8]	OFF	All users regardless of their programmed Schedules

Burglar Alarm On Forced Door or Door Left Open

VHFWIRQ ^636 ; '=RSWIRQ ^8 \ +IRUFHG GRRU ,

VHFWIRQ ^636 ; '=RSWIRQ ^ : \ +GRRU OHIW RSHQ ,

(default = **disabled**) If an Access Door is forced open or left open, a signal can be sent to the control panel to trigger the burglar alarm. The burglar alarm is generated instantly regardless of the zone's definition.

For these features to function:

- Install a door contact and connect it to the door's Access Control Module
- Assign the Access Control Module to a zone (see *Zone Programming* on page 14)
- Enable option [5] in section [3038]: Burglar Alarm on Forced Door
- Enable option [7] in section [3038]: Burglar Alarm on Door Left Open

Logging Access Control Events

Log Request For Exit In Event Buffer

VHFWIRQ ^636 ; '=RSWIRQ ^5 \

(default = **disabled**) When enabled, the control panel can record the REX events generated from all the Doors in the Event Buffer, but cannot report these events to the monitoring station. The events can be viewed by entering the *Event Record Display*.

NOTE: Since REX events can occur often, the Event Buffer may fill up quickly.

Log Door Left Open Restore In Event Buffer

VHFWIRQ ^636 ; '=RSWIRQ ^6 \

(default = **disabled**) When enabled, the Door Left Open Restore event can be recorded in the Event Buffer. These events cannot be reported to the monitoring station, but can be viewed by entering the *Event Record Display*.

Log Door Forced Open Restore In Event Buffer

VHFWIRQ ^636 ; '=RSWIRQ ^7 \

(default = **disabled**) When enabled, the Door Forced Open Restore event can be recorded in the Event Buffer. This event cannot be reported to the monitoring station, but it can be viewed by entering the *Event Record Display*.

BabyWare Software

Panel Identifier

VHFWIRQ ^6344`

(default = **0000**) Program the same Panel Identifier in the control panel and BabyWare. BabyWare will establish communication on matching identifier. Enter the desired 4-digit hexadecimal number into section **[3011]**.

PC Password

VHFWIRQ ^6345`

(default = **0000**) Program the same Password in the control panel and BabyWare. BabyWare will establish communication on matching passwords. Enter the desired four-digit hexadecimal number into section **[3012]**.

PC Telephone Number

VHFWIRQ ^6343`

The control panel dials this number to communicate with a computer using BabyWare. Enter any digit from 0 to 9 and any special keys or functions (see *Table 5: Special Telephone Number Keys* on page 30) up to a maximum of 32 digits into section **[3010]**.

Call Back Feature

VHFWIRQ ^636: `=RSWIRQ ^4`

(default = **disabled**) If enabled and a computer using BabyWare attempts to communicate with the control panel, the control panel hangs up and calls the computer back to verify identification codes and establish communication. When the control panel hangs up, BabyWare automatically goes into *Wait For Call Mode* (see "BabyWare Online Help"), ready to answer when the control panel calls back. The PC Telephone Number must be programmed.

Call BabyWare

Dial the PC Telephone Number programmed in section **[3010]** to communicate with BabyWare. The control panel and BabyWare verify that the Panel Identifier and the PC Password match before establishing communication.

For LCD Keypads: Press and hold the [0] key, enter your [installer code] and then press [force].

Answering Machine Override Delay

VHFWIRQ ^6385`

(default = **008**) Program the Answering Machine Override if BabyWare is used to communicate with an installation that uses an answering machine or service.

Program a value (00 to 15 X 4 seconds, 00 = disabled) representing the delay period the control panel will wait between the first and second call.

To use:

1. Call the installation and, with BabyWare, press **[ENTER]** on the keyboard or hang up manually on the second ring.
2. After hanging up, BabyWare immediately calls the installation back or call back manually.

Ring Counter

VHFWIRQ ^6384`

(default = **008**) The Ring Counter represents the number of rings the control panel will wait before picking up the line. If more than 10 seconds pass between each ring, the Ring Counter resets. Enter any value between 01 to 15 (00 = disabled).

Event Buffer Transmission

VHFWIRQ ^636: `=RSWIRQ ^5`

(default = **disabled**) Once the Event Buffer contains 1998 events, the control panel makes two attempts to establish communication through BabyWare by calling the PC Telephone Number programmed in section **[3010]**. BabyWare must be in *Wait To Dial* mode. The control panel uploads the contents of the Event Buffer to BabyWare. If communication is interrupted before completing transmission or communication is not established after two attempts, the

control panel wait until the Event Buffer receives another 1998 events before attempting Event Buffer Transmission. The Event Buffer can hold 2048 Events. If it is full, new event will erase old ones.

In-Field Firmware Upgrade

1. Connect the CONV4USB or the 307USB to the "Serial" or "Upgrade" port of the module or panel as shown in *Figure 21* and *Figure 22* on page 45.
2. Start BabyWare and click on the In-Field Firmware Programmer button.
3. Verify the **product information** located in the window.
4. In the drop down menu, select the most recent version of the firmware.
5. Use this button to load additional firmware files from another location or click **Download firmware from the web** to get the latest firmware online.
6. Click on **Update product firmware**.

NOTE: If the upgrade process is not completed properly, either because Cancel was pressed or because of technical problems, the panel or module will not function until a firmware is properly transferred.

Figure 21: Upgrading Control Panels and Modules

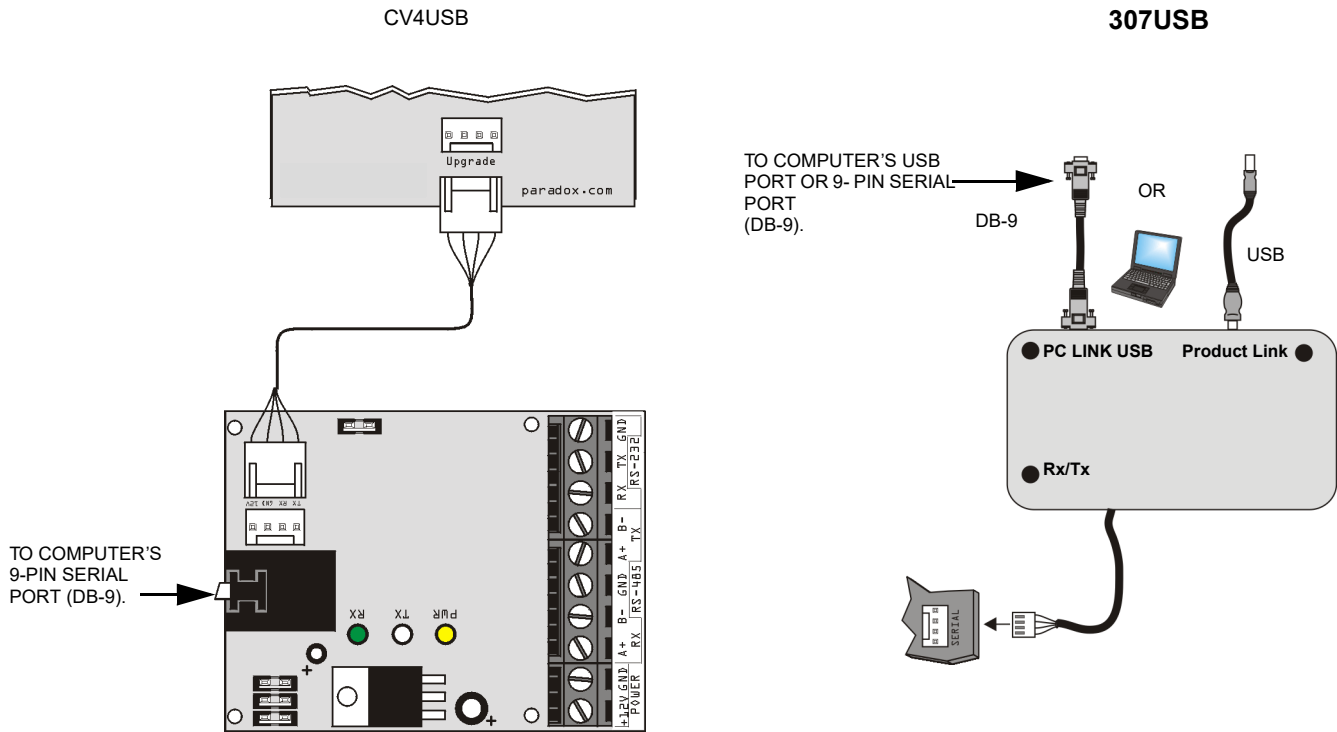
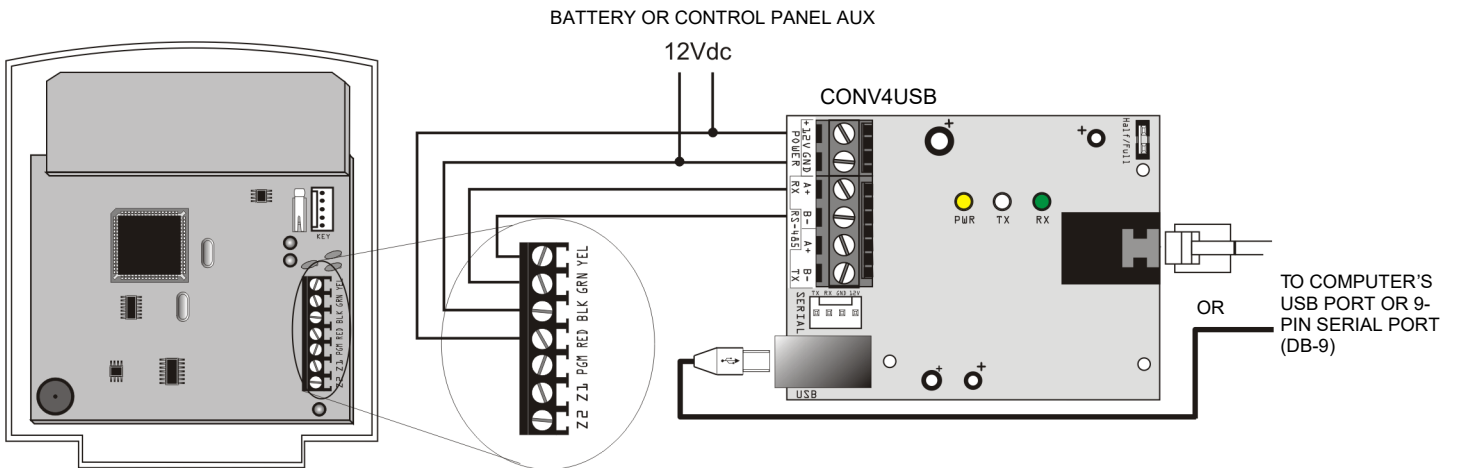

Figure 22: Upgrading K641, K641R, K641+ Keypads



NOTE: K641, K641+, and K641R keypads that feature a four-pin serial connector can also be upgraded using the 307USB. To do this, the keypad's GRN and YEL Digiplex bus wires must first be disconnected.

Appendix 1: Automatic Report Code List

System Event	Default Contact ID Report Code (when using sections [4032] to [4037])		Default SIA Report Code (when using sections [4032] to [4037])	
Arming with master code (##)	3 4A1	Close by user	CL	Closing report
Arming with user code (##)	3 4A1	Close by user	CL	Closing report
Arming with keyswitch (##)	3 4A9	Keyswitch close	CS	Closing keyswitch
Auto arming	3 4A3	Automatic close	CA	Automatic closing
Arm with PC software	3 4A7	Remote arm/disarm	CQ	Remote arming
Late to close	3 452	Late to close	OT	Late to close
No movement	3 452	Late to close	NA	No movement arming
Partial arming	1 456	Partial arm	CG	Close area
Quick arming	3 4A8	Quick arm	CL	Closing report
Remote arm (voice)	3 4A7	Remote arm	CQ	Arm with voice module
Delinquency closing	1 654	System inactivity	CD	System inactivity
Disarm with master code (##)	1 4A1	Open by user	OP	Opening report
Disarm with user code (##)	1 4A1	Open by user	OP	Opening report
Disarm with keyswitch (##)	1 4A9	Keyswitch open	OS	Opening keyswitch
Disarm after alarm with master code (##)	1 4A1	Open by user	OP	Opening report
Disarm after alarm with user code (##)	1 4A1	Open by user	OP	Opening report
Disarm after alarm with keyswitch (##)	1 4A9	Keyswitch open	OS	Opening keyswitch
Cancel alarm with master code (##)	1 4A6	Cancel	OR	Disarm from alarm
Cancel alarm with user code (##)	1 4A6	Cancel	OR	Disarm from alarm
Cancel alarm with keyswitch (##)	1 4A6	Cancel	OS	Opening keyswitch
Auto arming cancellation	1 464	Auto-arm time extended	CE	Closing extend
Cancel alarm with PC software	1 4A6	Cancel	OR	Disarm from alarm
Voice disarm	1 4A7	Remote arm/disarm	OQ	Remote disarming
Disarm with PC software	1 4A7	Remote arm/disarm	OQ	Remote disarming
Disarm after an alarm with PC software	1 4A7	Remote arm/disarm	OQ	Remote disarming
Quick disarm	1 4A8	Quick disarm	OP	Opening report
Zone Bypassed (##)	1 57A	Zone bypass	UB	Untyped zone bypass
Zone alarm (##)	1 13A	Burglary alarm	BA	Burglary alarm
Fire alarm (##)	1 11A	Fire alarm	FA	Fire alarm
Early to Disarm by User	1 451	Early to open	OK	Early to open
Late to Disarm by User	1 452	Late to open	OJ	Late to open
Failed to arm	1 454	Failed to close	CI	Failed to close
Zone alarm restore (##)	3 13A	Burglary alarm restore	BH	Burglary alarm restore
Fire alarm restore (##)	3 11A	Fire alarm restore	FH	Fire alarm restore
24-hr Gas alarm (##)	1 13A	Burglary alarm	GA	Gas alarm
24-hr Heat alarm (##)	1 13A	Burglary alarm	KA	Heat alarm
24-hr Water alarm (##)	1 13A	Burglary alarm	WA	Water alarm
24-hr Freeze alarm (##)	1 13A	Burglary alarm	ZA	Freeze alarm
24-hr Gas alarm restore (##)	3 13A	Burglary alarm restore	GR	Gas alarm restore
24-hr Heat alarm restore (##)	3 13A	Burglary alarm restore	KR	Heat alarm restore
24-hr Water alarm restore (##)	3 13A	Burglary alarm restore	WR	Water alarm restore
24-hr Freeze alarm restore (##)	3 13A	Burglary alarm restore	ZR	Freeze alarm restore
Panic 1: emergency	1 12A	Panic alarm	PA	Panic alarm
Panic 2: medical	1 1AA	Medical alarm	MA	Medical alarm
Panic 3: fire	1 115	Pull station	FA	Fire alarm
Recent closing	3 459	Recent close	CR	Recent closing
Police code	1 139	Burglary alarm	BM	Burglary alarm
Global zone shutdown	1 574	Group bypass	CG	Close area
Duress alarm	1 121	Duress	HA	Hold-up alarm
Zone shutdown (##)	1 57A	Zone bypass	UB	Untyped zone bypass

System Event	Default Contact ID Report Code (when using sections [4032] to [4037])		Default SIA Report Code (when using sections [4032] to [4037])	
Zone tampered (##)	1 144	Sensor tamper	TA	Tamper alarm
Zone tamper restore (##)	3 144	Sensor tamper restore	TR	Tamper restoral
Keypad lockout	1 421	Access denied	JA	User code tamper
AC failure	1 3A1	AC loss	AT	AC trouble
Battery failure	1 3A9	Battery test failure	YT	System battery trouble
Auxiliary supply trouble	1 3AA	System trouble	YP	Power supply trouble
Bell output current limit	1 321	Bell 1	YA	Bell fault
Bell absent	1 321	Bell 1	YA	Bell fault
Clock lost	1 626	Time/date inaccurate	JT	Time changed
Fire loop trouble	1 373	Fire trouble	FT	Fire trouble
Panel tamper	1 144	Sensor tamper	TA	Tamper alarm
TLM trouble restore	3 351	Telco 1 fault restore	LR	Phone line restoral
AC failure restore	3 3A1	AC loss restore	AR	AC restoral
Battery failure restore	3 3A9	Battery test restore	YR	System battery restoral
Auxiliary supply trouble restore	3 3AA	System trouble restore	YQ	Power supply restored
Bell output current limit restore	3 321	Bell 1 restore	YH	Bell restored
Bell absent restore	3 321	Bell 1 restore	YH	Bell restored
Clock programmed	3 625	Time/date reset	JT	Time changed
Fire loop trouble restore	3 373	Fire trouble restore	FJ	Fire trouble restore
Panel tamper restore	1 373	Sensor tamper restore	FT	Tamper restoral
Combus fault	1 333	Expansion module failure	ET	Expansion trouble
Module tamper	1 145	Expansion module tamper	TA	Tamper alarm
Module ROM_RAM_error	1 3A4	ROM checksum bad	YF	Parameter checksum fail
Module TLM trouble	1 352	Telco 2 fault	LT	Phone line trouble
Module fail to communicate to monitoring station	1 354	Fail to communicate	YC	Communication fails
Printer fault	1 336	Local printer failure	VT	Printer trouble
Module AC failure	1 3A1	AC loss	AT	AC trouble
Module battery failure	1 3A9	Battery test failure	YT	System battery trouble
Module auxiliary supply trouble	1 3AA	System trouble	YP	Power supply trouble
Module IP receiver supervision	-	-	-	-
Module IP receiver fail to communicate	-	-	-	-
Module IP receiver unregistered	-	-	-	-
Direct light	-	-	-	-
Module Rf Interference	1 344	RF receiver Jam	XQ	RF Jamming
Module low voltage	-	-	-	-
Module self-test error	-	-	-	-
Module LAN trouble	-	-	-	-
Module WAN trouble	-	-	-	-
Combus fault restore	3 333	Expansion module failure restore	ER	Expansion restoral
Panel tamper restore	3144	Sensor tamper restore	TR	Tamper Restoral
Module tamper restore	3 145	Expansion module tamper restore	TR	Tamper restoral
Module ROM_RAM_error restore	3 3A4	ROM checksum bad restore	YG	Parameter changed
Module TLM restore	3 352	Telco 2 fault restore	LR	Phone line restoral
Early to arm by user	3 451	Early to close	CK	Early to close
Late to arm by user	3 452	Late to close	CJ	Late to close
Zone excluded on Force arming	1 57A	Zone bypass	XW	Zone forced
Zone went back to arm status	3 57A	Zone bypass restore	UU	Zone included
Printer fault restore	3 336	Local printer failure restore	VR	Printer restore
Module AC restore	3 3A1	AC loss restore	AR	AC restoral
Module battery restore	3 3A9	Battery test failure restore	YR	System battery restoral
Module auxiliary supply restore	3 3AA	System trouble restore	YQ	Power supply restored
Module IP receiver supervision restore	-	-	-	-
Module IP receiver fail to communicate restore	-	-	-	-

System Event	Default Contact ID Report Code (when using sections [4032] to [4037])		Default SIA Report Code (when using sections [4032] to [4037])	
Module IP receiver unregistered restore	-	-	-	-
Direct light restore	-	-	-	-
Module Rf Interference restore	3 344	RF receiver Jam restore	XH	RF Jamming restoral
Module low voltage restore	-	-	-	-
Module self-test error restore	-	-	-	-
Module LAN trouble restore	-	-	-	-
Module WAN trouble restore	-	-	-	-
Fail to communicate with monitoring station	1 354	Fail to communicate	YC	Communication fails
Module RF low battery	1 384	RF transmitter low battery	XT	Transmitter battery trouble
Module RF supervision trouble	1 381	Loss of supervision - RF	US	Untype zone supervision
Module RF battery restore	3 384	RF transmitter battery restore	XR	Transmitter battery restoral
Module RF supervision restore	3 381	Supervision restore - RF	UR	Untyped zone restoral
Cold start	1 3A8	System shutdown	RR	Power up
Warm start	1 3A5	System reset	YW	Watchdog reset
Test report engaged	1 6A2	Periodic test report	TX	Test report
Listen-in request	1 606	Listen-in to follow	LF	Listen-in to follow
BabyWare login request	1 411	Call back Request	RB	Remote program begin
PC software communication finished	1 412	Successful - download access	RS	Remote program success
Installer on site	1 627	Program mode entry	LB	Local program
Installer programming finished	1 628	Program mode exit	LS	Local program success
Module fail to communicate restore	3 354	Fail to communicate restore	YK	Communication restore
Missing PCS module	1 552	Radio transmitter disabled	YS	Communication trouble
GSM RF jam	1 552	Radio transmitter disabled	YS	Communication trouble
GSM no service	1 552	Radio transmitter disabled	YS	Communication trouble
GPRS FTC IPR512	1 354	Fail to communicate	YA	Communication fails
Missing IP module	1 552	Radio transmitter disabled	YS	Communication trouble
IP no service	1 552	Radio transmitter disabled	YS	Communication trouble
IP150 FTC IPR512	1 354	Fail to communicate	YA	Communication fails
Missing PCS module restore	3 552	Radio transmitter restore	YK	Communication restore
GSM RF jam restore	3 552	Radio transmitter restore	YK	Communication restore
GPRS FTC IPR512 restore	3 354	Fail to communicate restore	YK	Communication restore
Missing IP module restore	3 552	Radio transmitter restore	YK	Communication restore
IP no service restore	3 552	Radio transmitter restore	YK	Communication restore
IP150 FTC IPR512 restore	3 354	Fail to communicate restore	YK	Communication restore

Appendix 2: Contact ID Report Code List

If using the Ademco contact ID format, enter the two-digit hexadecimal value (under the column heading *Value* in table 17) to program the desired report codes into sections [0201] to [0296], [0701] to [0832], [2001] to [2199], and [3900] to [3999].

Table 17: List of Ademco contact ID report codes

Type	CID #	Reporting Code	Value
Medical Alarms (100)	100	Medical alarm	01
	101	Personal emergency	02
	102	Fail to report in	03
Fire Alarms (110)	110	Fire Alarm	04
	111	Smoke	05
	112	Combustion	06
	113	Water Flow	07
	114	Heat	08
	115	Pull Station	09
	116	Duct	0A
	117	Flame	0B
Panic Alarms (120)	118	Near Alarm	0C
	120	Panic alarm	0D
	121	Duress	0E
	122	Silent	0F
	123	Audible	10
Burglar Alarms (130)	124	Duress - access granted	11
	125	Duress - egress granted	12
	130	Burglary	13
	131	Perimeter	14
	132	Interior	15
	133	24-hour	16
	134	Entry/exit	17
General Alarms (140)	135	Day/night	18
	136	Outdoor	19
	137	Tamper	1A
	138	Near alarm	1B
	139	Intrusion verifier	1C
	140	General alarm	1D
24-hour Non-burglary (150 & 160)	141	Polling loop open	1E
	142	Polling loop short	1F
	143	Extension module failure	20
	144	Sensor tamper	21
	145	Expansion module tamper	22
	146	Silent burglary	23
	147	Sensor supervision failure	24
	150	24-hour non-burglary	25
24-hour Non-burglary (150 & 160)	151	Gas detected	26
	152	Refrigeration	27
	153	Loss of heat	28
	154	Water leakage	29
	155	Foil break	2A
	156	Day trouble	2B
	157	Low bottled gas level	2C
	158	High temperature	2D

Table 17: List of Ademco contact ID report codes

Type	CID #	Reporting Code	Value
24-hour Non-burglary (150 & 160) (cont.)	159	Low temperature	2E
	161	Loss of air flow	2F
	162	Carbon monoxide detected	30
	163	Tank level	31
Fire Supervisory (200)	200	Fire supervisory	32
	201	Low water pressure	33
	202	Low CO2	34
	203	Gate valve sensor	35
	204	Low water level	36
	205	Pump activated	37
	206	Pump failure	38
System Troubles (300 & 310)	300	System trouble	39
	301	AC loss	3A
	302	Low system battery	3B
	303	RAM checksum bad	3C
	304	ROM checksum bad	3D
	305	System reset	3E
	306	Panel program changed	3F
	307	Self-test failure	40
	308	System shutdown	41
	309	Battery test failure	42
	310	Ground fault	43
	311	Battery missing/dead	44
	312	Power supply over current	45
Sounder/Relay Troubles (320)	313	Engineer reset	46
	320	Sounder relay	47
	321	Bell 1	48
	322	Bell 2	49
	323	Alarm relay	4A
	324	Trouble relay	4B
	325	Reversing relay	4C
	326	Notification appliance chk. #3	4D
	327	Notification appliance chk. #4	4E

Table 17: List of Ademco contact ID report codes

Type	CID #	Reporting Code	Value
System Peripheral Troubles (330 & 340)	330	System peripheral	4F
	331	Polling loop open	50
	332	Polling loop short	51
	333	Expansion module failure	52
	334	Repeater failure	53
	335	Local printer paper out	54
	336	Local printer failure	55
	337	Exp. module DC low	56
	338	Exp. module low batt	57
	339	Exp. module reset	58
	341	Exp. module tamper	59
	342	Exp. module AC lost	5A
	343	Exp. module self-test fail	5B
	344	RF receiver jam detected	5C
Communication Troubles (350)	350	Communication	5D
	351	Telco fault 1	5E
	352	Telco fault 2	5F
	353	Long range radio	60
	354	Fail to communicate	61
	355	Loss of radio supervision	62
	356	Loss of central polling	63
Protection Loop Troubles (370)	357	Long range radio VSWR problem	64
	370	Protection loop	65
	371	Protection loop open	66
	372	Protection loop short	67
	373	Fire trouble	68
	374	Exit error alarm	69
	375	Panic zone trouble	6A
	376	Hold-up zone trouble	6B
	377	Swinger trouble	6C
	378	Cross-zone trouble	6D
	Sensor Troubles (380 & 390)	380	Sensor trouble
381		Loss of supervision - RF	6F
382		Loss of supervision - RPM	70
383		Sensor tamper	71
384		RF transmitter low battery	72
385		Smoke detector hi sensitivity	73
386		Smoke detector low sensitivity	74
387		Intrusion detector hi sensitivity	75
388		Intrusion detector low sensitivity	76
389		Sensor self-test failure	77
391		Sensor watch trouble	78
392		Drift compensation error	79
393		Maintenance alert	7A

Table 17: List of Ademco contact ID report codes

Type	CID #	Reporting Code	Value
Open/Close (400)	400	Open/close	7B
	401	Open/close by user	7C
	402	Group open/close	7D
	403	Automatic open/close	7E
	406	Cancel	7F
	407	Remote arm/disarm	80
	408	Quick arm	81
	409	Keypad open/close	82
	Remote Access (410)	411	Callback request made
412		Successful - download access	84
413		Unsuccessful access	85
414		System shutdown	86
415		Dialer shutdown	87
416		Successful upload	88
Access Control (420, 430 & 440)	421	Access denied	89
	422	Access report by user	8A
	423	Forced access	8B
	424	Egress denied	8C
	425	Egress granted	8D
	426	Access door propped open	8E
	427	Access point door status monitor trouble	8F
	428	Access point request to exit	90
	429	Access program mode entry	91
	430	Access program mode exit	92
	431	Access threat level change	93
	432	Access relay/trigger fail	94
	433	Access RTE shunt	95
	434	Access DSM shunt	96
	441	Armed stay	97
	442	Keypad armed stay	98
Special Troubles (450 & 460)	450	Exception open/close	99
	451	Early open/close	9A
	452	Late open/close	9B
	453	Failed to open	9C
	454	Failed to close	9D
	455	Auto-arm failed	9E
	456	Partial arm	9F
	457	User exit error	A0
	458	User on premises	A1
	459	Recent close	A2
	461	Wrong code entry	A3
	462	Legal code entry	A4
	463	Re-arm after alarm	A5
	464	Auto-arm time extended	A6
465	Panic alarm reset	A7	
466	Service ON/OFF premises	A8	

Table 17: List of Ademco contact ID report codes

Type	CID #	Reporting Code	Value
Sounder Relay Disables (520 & 530)	520	Sounder/relay disabled	A9
	521	Bell 1 disable	AA
	522	Bell 2 disable	AB
	523	Alarm relay disable	AC
	524	Trouble relay disable	AD
	525	Reversing relay disable	AE
	526	Notification appliance chk. #3 disabled	AF
	527	Notification appliance chk. #4 disabled	B0
	531	Module added	B1
	532	Module removed	B2
Communication Disabled (550)	551	Dialer disabled	B3
	552	Radio transmitter disabled	B4
Bypasses (570)	570	Zone bypass	B5
	571	Fire bypass	B6
	572	24-hour zone bypass	B7
	573	Burglary bypass	B8
	574	Group bypass	B9
	575	Swinger bypass	BA
	576	Access zone shunt	BB
577	Access point bypass	BC	

Table 17: List of Ademco contact ID report codes

Type	CID #	Reporting Code	Value
Test/Misc (600, 610, 620, 630 & 650)	601	Manual trigger test	BD
	602	Periodic test report	BE
	603	Periodic RF transmission	BF
	604	Fire test	C0
	605	Status report to follow	C1
	606	Listen-in to follow	C2
	607	Walk test mode	C3
	608	Periodic test - system trouble present	C4
	609	Video xmitter active	C5
	611	Point test Ok	C6
	612	Point not tested	C7
	613	Intrusion zone walk tested	C8
	614	Fire zone walk tested	C9
	615	Panic zone walk tested	CA
	616	Service request	CB
	621	Event log reset	CC
	622	Event log 50% full	CD
	623	Event log 90% full	CE
	624	Event log overflow	CF
	625	Time/date reset	D0
	626	Time/date inaccurate	D1
	627	Program mode entry	D2
	628	Program mode exit	D3
	629	32-hour event log marker	D4
	630	Schedule change	D5
	631	Exception schedule change	D6
	632	Access schedule change	D7
	654	System inactivity	D8

Appendix 3: Keypad Installation Instructions

Keypad Installation Instructions

Connecting the Keypads

The keypads are connected to the control panel's Digiplex bus in a star and/or daisy chain configuration. Connect the four terminals labeled red, black, green and yellow of each keypad to the corresponding terminals on the control panel.

Connecting Keypad Zones

Each keypad has one hardwired input terminal, allowing you to connect one detector or door contact directly to it. Connect the device to the keypad's input terminal as shown in *Figure 5* on page 6. In order to communicate its status to the control panel, the keypad's input must be assigned to a zone in the control panel and the zone's parameters must be defined.

Programmable Output

Each keypad has one on-board PGM. Upon activation, the PGM can provide 50mA to any device connected to it. If the current drawn is to exceed the current limit, a relay should be connected to the PGM as shown in *Figure 5* on page 6.

Keypad Specific Instructions

Memory Key Connection

A memory key can be used to download programming to the K641, K641R, and K641+ keypads.

Memory Key

VHFWRQV ^843 `DQG ^853 `

Download information using the memory key (PMCS).

Section [510] = Download all from the memory key (LCD keypad sections [001] to [396] and all messages) to the LCD keypad.

Section [520] = Copy the LCD keypad sections [001] to [396] and all messages to the memory key.

Download Contents of Memory Key to Keypad

VHFWRQ ^843 `

1. Insert the memory key into the keypad's connector labelled "KEY."
2. To download the contents of the memory key, enter the keypad's programming mode and enter section [510].
3. When the keypad emits a confirmation beep, wait 5 seconds and remove the memory key after the second confirmation beep.

Copy the Keypad Contents to the Memory Key

VHFWRQ ^853 `

1. Insert the memory key onto the keypad's connector labelled "KEY." Ensure that the write protect jumper is ON.
2. To copy the contents to the memory key, enter the keypad's programming mode and enter section [520].
3. After the confirmation beep, wait 5 seconds and remove the memory key after the second confirmation beep. Set the memory key's jumper to OFF if you do not wish to accidentally overwrite its contents.

Figure 23: PMC5 Jumper Settings

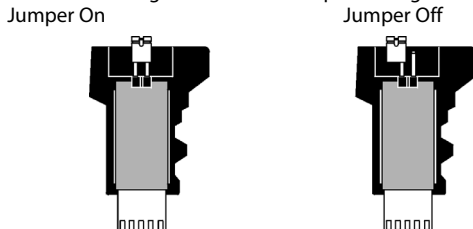

K641R Access Control Connection

Figure 24: Typical Access Control Installation

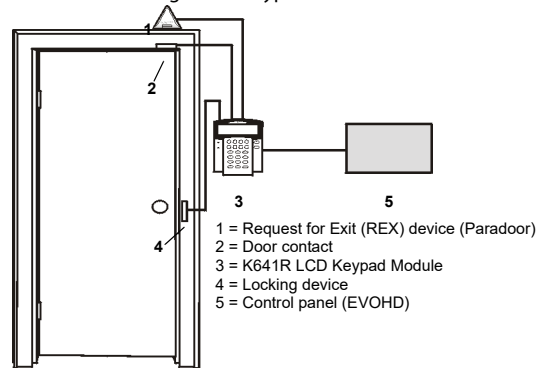

Figure 25: Access Control Overview

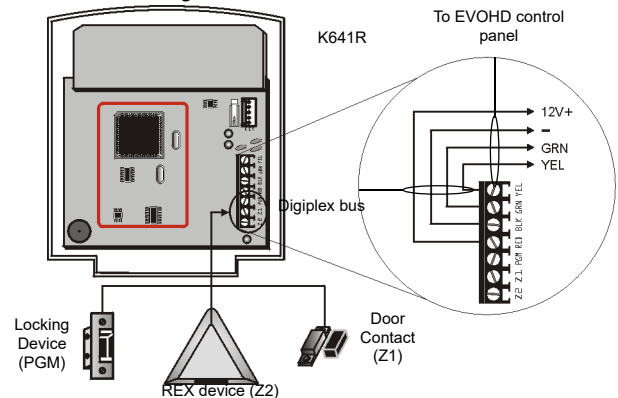
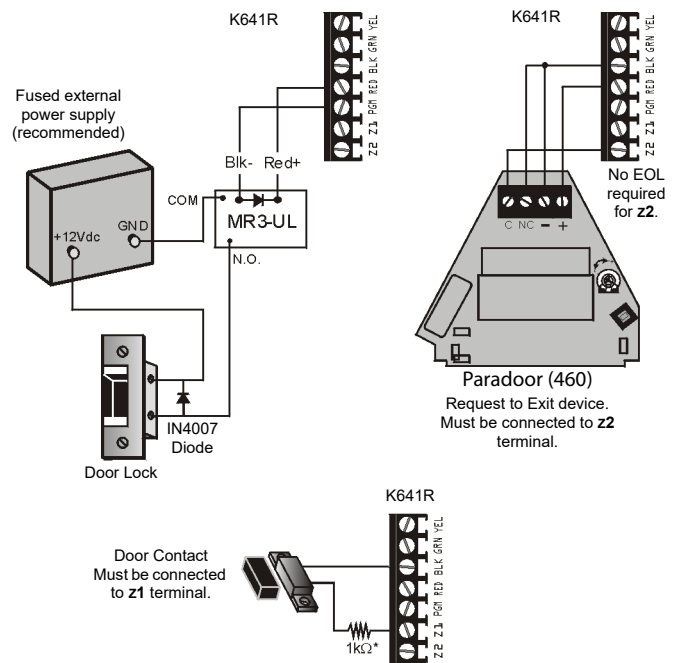

Figure 26: Access Control Connections



* Follows control panel's EOL definition.

NOTE: If a door contact is not being used, install a jumper or a 1kOhm resistor across the blk and z1 terminals depending on the control panel's EOL definition. If the REX (Request for Exit) device is not being used, place a jumper across the blk and z2 terminals.

Programming

Entering Module Programming Mode

The keypad is programmed through the control panel. To do so, you must first enter Module Programming Mode:

1. From Normal Mode press and hold the **[0]** key.
2. Enter the **[INSTALLER CODE]** (Default: 000000).
3. Enter section **[4003]**.
4. Enter the keypad's 8-digit **[SERIAL NUMBER]**.
5. Enter the 3-digit **[SECTION]** you want to program.
6. Enter the required **[DATA]**.

The control panel will then redirect all programming to the selected keypad. Every time the **[CLEAR]** key is pressed it will revert to the preceding step, unless entering in data in which case it will erase the current data entry. Please note that the serial number is located on the keypad's PC board or enter section **[000]** in Step 3 to view the keypad's serial number.

Module Broadcast

The control panel's Module Broadcast feature can be used to copy the contents of one keypad to one or more keypads.

1. From Normal Mode press and hold the **[0]** key.
2. Enter **[INSTALLER CODE]** (Default: 000000).
3. Enter section **[4004]**.
4. Enter the **[SERIAL #]** of the source keypad. The *source* is the programmed keypad whose data you want to copy to other keypads.
5. Enter the **[SERIAL #]** of the destination keypads. The *destination* is the keypad(s) you want to program with the source's data. If you want to program more than one keypad with the source's data, enter the serial numbers of the keypads one at a time.
6. Once you have entered the serial numbers of the keypads you want to program, press the **[ACC]** key.

Message Programming K641/K641R/K641+

VHFWIRQV ^434 \ WR ^47 ; ^/ ^533 \ WR ^537 \ /DQG ^634 \ WR ^6<9 \

Each section contains one message with a maximum of 16 characters. For more details and to record any changes, use the *Digiplex Modules' Programming Guide*.

NOTE: The EVOHD control panel supports up to 8 partitions, 192 zones, and up to 999 user codes. The LCD keypad only allows you to program the messages for up to 4 partitions, 48 zones and 96 user codes. The rest of the messages can be programmed directly into the EVOHD control panel. Refer to the EVOHD Reference & Installation Manual and to the EVOHD Programming Guide for more details.

Section **[101]** to **[148]** = "Zone 01" to "Zone 48" respectively

Section **[200]** = "Paradox Security"

Section **[201]** to **[204]** = "First Area", "Second Area", "Third Area", and "Fourth Area" respectively

Section **[301]** to **[396]** = "Code 01" to "Code 96" respectively

After entering the section corresponding to the desired message, use the Message Programming Keys (refer to *Table 9*) and *Table 8* on page 38 to change the message to suit your installation needs.

K641/K641+ Programming

Partition Assignment

VHFWIRQ ^334 \ =R.SWIRQV ^4 \ WR ^; \

To assign the keypad to a partition, simply enable the option that corresponds to the desired partition. By default, partitions 1 to 8 are enabled.

Display Access Code Entry

VHFWIRQ ^336 \ =R.SWIRQ ^4 \

- Option **[1]** OFF = Digits are replaced by a * (default)
 Option **[1]** ON = Access Code digits will be displayed

Display Exit Delay Timer

VHFWIRQ ^336 \ =R.SWIRQ ^5 \

- Option **[2]** OFF = Will not display Exit Delay timer (default)
 Option **[2]** ON = LCD screen will display Exit Delay timer

Display Entry Delay Timer

VHFWIRQ ^336 \ =R.SWIRQ ^6 \

- Option **[3]** OFF = Will not display the Entry Delay Timer (default)
 Option **[3]** ON = LCD screen will display Entry Delay Timer

Confidential Mode

VHFWIRQ ^336 \ =R.SWIRQV ^7 \ /DQG ^8 \

In Confidential Mode, all LEDs will turn off and the display will change until either a button is pressed or an access code is entered.

- Option **[4]** OFF = Normal Mode (default)
 Option **[4]** ON = Confidential Mode

- Option **[5]** OFF = LCD screen activated by entering an access code (default)
 Option **[5]** ON = LCD screen activated by pressing a button

Figure 27: LCD Screen

in *Normal Mode*:

PARADOX SECURITY
2004/10/01 09:07

in *Confidential Mode*:

CONFIDENTIAL
2004/10/01 09:07

Confidential Mode Timer

VHFWIRQ ^33 : \

Section **[007]** determines the amount of time without action before the keypad enters Confidential Mode. The Confidential Mode Timer can be set from 005 seconds to 255 seconds. Default: 120 seconds.

Time Display Option

VHFWIRQ ^336 \ =R.SWIRQ ^; \

- Option **[8]** OFF = Date displayed as yy/mm/dd (default)
 Option **[8]** ON = Date displayed as dd/mm/yy

Muting

VHFWIRQ ^337 \ =R.SWIRQ ^4 \

- Option **[1]** OFF = Audible sounds (default)
 Option **[1]** ON = Mute

Beep on Exit Delay

VHFWIRQ ^337 \ =R.SWIRQ ^5 \

- Option **[2]** OFF = Exit Delay beep disabled
 Option **[2]** ON = Exit Delay beep enabled (default)

Chime on Zone Closure

VHFWIRQ ^337 \ =R.SWIRQ ^7 \

- Option **[4]** OFF = Chime on Zone Closure disabled (default)
 Option **[4]** ON = Chime on Zone Closure enabled

Beep on Trouble

VHFWIRQ ^338 \ =R.SWIRQV ^4 \ WR ^7 \

- Option **[1]** OFF = Beep disabled: System Troubles and Clock Loss (default)
 Option **[1]** ON = Beep enabled: System Troubles and Clock Loss

- Option **[2]** OFF = Beep disabled: Communicator Troubles (default)
 Option **[2]** ON = Beep enabled: Communicator Troubles

- Option **[3]** OFF = Beep disabled: Module and Bus Troubles (default)
 Option **[3]** ON = Beep enabled: Module and Bus Troubles

- Option **[4]** OFF = Beep disabled: all Zone Troubles (default)
 Option **[4]** ON = Beep enabled: all Zone Troubles

Keypad Tamper Enable

VHFWIRQ ^339 '=R.SWIRQ ^8 \

- Option [5] OFF = Keypad's tamper is disabled (default)
- Option [5] ON = Keypad's tamper is enabled

Digiplex bus Voltmeter

- From Normal Mode press and hold the [0] key.
- Enter the [INSTALLER CODE] (Default: 000000).
- Press [ACC].

NOTE: The voltage may drop during the control panel battery test.

Programmable Output Options

PGM State

VHFWIRQ ^339 '=R.SWIRQ ^4 \

- Option [1] OFF = PGM is Normally Open (default)
- Option [1] ON = PGM is Normally Closed

NOTE: The PGM can provide 50mA to any device connected to it.

PGM Deactivation Mode

VHFWIRQ ^339 '=R.SWIRQ ^5 \

- Option [2] OFF = Deactivates on PGM Deactivation Event (default)
- Option [2] ON = PGM will deactivate according to the PGM Timer

PGM Base Time

VHFWIRQ ^339 '=R.SWIRQ ^6 \

- Option [3] OFF = PGM Base Time is 1 second (default)
- Option [3] ON = PGM Base Time is 1 minute

PGM Override

VHFWIRQ ^339 '=R.SWIRQ ^7 \

When the PGM override is enabled, the keypad's on-board PGM will ignore PGM Activation Events (*section*), PGM Deactivation Events (*section*), and PGM Timers (*section*). It will remain in its normal state until the PGM Override is disabled. This option may be used to test the PGM connections.

- Option [4] OFF = PGM Override disabled (default)
- Option [4] ON = PGM Override enabled

PGM Timer

VHFWIRQ ^33 ; \

The value programmed in section [008] represents how long the PGM will remain in its opposite state after being activated. To program the timer, enter a 3-digit decimal value (000 to 255) in section [008]. Default: 5 seconds.

PGM Activation Event

VHFWIRQV ^33 < \ WR ^345 \

Enter the sections that correspond to the Event Group, Feature Group, Start # and End # of the PGM and enter the required data.

	Event Group	Feature Group	Start #	End #
PGM	[009]	[010]	[011]	[012]

PGM Deactivation Event

VHFWIRQV ^346 \ WR ^349 \

If the PGM Deactivation Option is set to follow the PGM Deactivation event, the PGM will return to its normal state when the event programmed in sections [013] to [016] occurs.

Enter the sections that correspond to the Event Group, Feature Group, Start # and End # of the PGM and enter the required data.

	Event Group	Feature Group	Start #	End #
PGM	[013]	[014]	[015]	[016]

K641R Programming

Partition Assignment

VHFWIRQ ^334 '=R.SWIRQV ^4 \ WR ^; \

To assign the keypad to a partition, enable the option that corresponds to the desired partition. *By default, partitions 1 to 8 are enabled.*

Display Access Code Entry

VHFWIRQ ^336 '=R.SWIRQ ^4 \

- Option [1] OFF=Digits are replaced by a "*" (default)
- Option [1] ON=Access Code digits will be displayed

Display Exit Delay Timer

VHFWIRQ ^336 '=R.SWIRQ ^5 \

- Option [2] OFF=Will not display Exit Delay timer (default)
- Option [2] ON=LCD screen will display Exit Delay timer

Display Entry Delay Timer

VHFWIRQ ^336 '=R.SWIRQ ^6 \

- Option [3] OFF=Will not display the Entry Delay Timer (default)
- Option [3] ON=LCD screen will display Entry Delay Timer

Confidential Mode

VHFWIRQ ^336 '=R.SWIRQV ^7 \ DQG ^8 \

Section [003]:

- Option [4] OFF=Normal Mode (default)
- Option [4] ON=Confidential Mode

- Option [5] OFF=LCD screen activated by entering an access code (default)
- Option [5] ON=LCD screen activated by pressing a button

Confidential Mode Timer

VHFWIRQ ^33 : \

Section [007] determines the amount of time without action before the keypad enters Confidential Mode. The Confidential Mode Timer can be set from 005 seconds to 255 seconds. *Default: 120 secs.*

Time Display Option

VHFWIRQ ^336 '=R.SWIRQ ^; \

- Option [8] OFF=Date displayed as yy/mm/dd (default)
- Option [8] ON=Date displayed as dd/mm/yy

Muting

VHFWIRQ ^337 '=R.SWIRQ ^4 \

- Option [1] OFF=Audible sounds (default)
- Option [1] ON=Mute

Beep on Exit Delay

VHFWIRQ ^337 '=R.SWIRQ ^5 \

- Option [2] OFF=Exit Delay beep disabled
- Option [2] ON=Exit Delay beep enabled (default)

Chime on Zone Closure

VHFWIRQ ^337 '=R.SWIRQ ^7 \

- Option [4] OFF=Chime on Zone Closure disabled (default)
- Option [4] ON=Chime on Zone Closure enabled

Beep on Trouble

VHFWIRQ ^338 '=R.SWIRQV ^4 \ WR ^7 \

- Option [1] OFF=Beep disabled: System Troubles and Clock Loss
- Option [1] ON=Beep enabled: System Troubles and Clock Loss

- Option [2] OFF=Beep disabled: Communicator Troubles
- Option [2] ON=Beep enabled: Communicator Troubles

- Option [3] OFF=Beep disabled: Module and Digiplex bus Troubles
- Option [3] ON=Beep enabled: Module and Digiplex bus Troubles

- Option [4] OFF=Beep disabled: all Zone Troubles
- Option [4] ON=Beep enabled: all Zone Troubles

Keypad Tamper Enable

VHFWIRQ ^339 '=RSWIRQ ^8 `

Option [5] OFF=Keypad's tamper is disabled (default)

Option [5] ON=Keypad's tamper is enabled

Time Format

VHFWIRQ ^338 '=RSWIRQ ^: `

Option [7] OFF=Time uses the International time format (default).

Option [7] ON=Time uses the US time format.

Digiplex bus Voltmeter

1. From Normal Mode press and hold the [0] key.
2. Enter the [INSTALLER CODE] (by default 000000).
3. Press [ACC].

NOTE: The voltage may drop during the control panel battery test.

Access Control Options

Assigning Doors To Partitions

VHFWIRQ ^335 '=RSWIRQV ^4 `WR ^; `

The Access Control door can be assigned to one or more partition(s) in the alarm system. This means that the actions performed with the Access Control Card will be directly linked to the partition(s) assigned to that door.

Option [1] ON =Door assigned to Partition 1(default)

Option [2] ON =Door assigned to Partition 2

Option [3] ON=Door assigned to Partition 3

Option [4] ON =Door assigned to Partition 4

Option [5] ON=Door assigned to Partition 5

Option [6] ON=Door assigned to Partition 6

Option [7] ON=Door assigned to Partition 7

Option [8] ON=Door assigned to Partition 8

OFF =Access Control Cards will not be able to arm and/or disarm partitions from the door's reader

Unlock on REX (Request For Exit)

VHFWIRQ ^339 '=RSWIRQ ^; `

Option [8] OFF=Unlock on REX disabled (default)

Option [8] ON=Unlock on REX enabled

Door Unlocked Period

VHFWIRQ ^33 ; `

Enter any value between 001 and 255 to determine the seconds the door can remain unlocked. *Default = 5 secs.*

Door Unlocked Period Extension

VHFWIRQ ^33 < `

The Door Unlocked Period Extension is the amount of time added to the Door Unlocked Period in section [008], which leaves the door unlocked longer. This will allow those with this feature enabled on their User Access Codes extra time to enter. Enter any value between 001 and 255 to determine the number of seconds to be added to the time programmed in section [008]. *Default = 15 secs.*

Relock Door

VHFWIRQ ^339 '=RSWIRQ ^9 `

Option [6] OFF=Locking device latches immediately (default)

Option [6] ON=Locking device latches when door closes

Door Unlocked Schedule

VHFWIRQ ^34 : `

The Door Unlocked Schedule determines the hours, days, and holidays that the door will remain unlocked. Program the Start Time and End Time according to the 24-hour clock within the same day. Use *Feature Select Programming* to set the options representing the Days.

Table 18: Door Unlocked Schedule

Option	Day	Option	Day
[1]	Sunday (S)	[5]	Thursday (T)

Table 18: Door Unlocked Schedule

[2]	Monday (M)	[6]	Friday (F)
[3]	Tuesday (T)	[7]	Saturday (S)
[4]	Wednesday (W)	[8]	Holidays (H)

Card Activates Door Unlocked Schedule

VHFWIRQ ^339 '=RSWIRQ ^4 `

Option [1] OFF=The Schedule activates without Card

Option [1] ON=Card activates Door Unlocked Schedule (default)

Door Left Open Access Alarm

VHFWIRQ ^339 '=RSWIRQ ^5 `

Table 19: Door Left Open Access Alarm

Section

[004]	Option [3] Door Left Open Pre-alarm Option [5] Door Left Open Alarm Option [6] Door Left Open Alarm follows
[010]	Door Left Open Interval
[011]	Door Left Open Pre-alarm Timer
[012]	Beep Timer for Door Left Open Alarm

Option [2] OFF=Door Left Open Alarm won't be generated (default)

Option [2] ON=Door Left Open Alarm is enabled

Door Left Open Interval Before Access Alarm

VHFWIRQ ^343 `

Enter any value between 001 and 255 to determine the number of seconds the door may remain open before the Access Alarm is triggered. *Default = 60 secs.*

Door Left Open Pre-Alarm

VHFWIRQ ^337 '=RSWIRQ ^6 `

Program the Pre-Alarm timer in section [011].

Option [3] OFF=The Pre-Alarm will not be generated

Option [3] ON=Pre-Alarm is enabled (default)

Door Left Open Pre-Alarm Timer

VHFWIRQ ^344 `

This timer will trigger the Door Left Open Pre-Alarm before the end of the Door Left Open Interval. Enter any value between 001 and 255 to determine the seconds before the expiry of the Door Left Open Interval that the reader will beep. *Default = 15 seconds.*

Door Left Open Alarm Feedback

VHFWIRQ ^337 '=RSWIRQV ^8 `DQG ^9 `

Option [5] OFF=The Door Left Open Alarm is silent

Option [5] ON=The Door Left Open Alarm is audible (default)

If option [5] is enabled:

Option [6] OFF=Beep as long as the Door Left Open Alarm is occurring (default)

Option [6] ON=Door Left Open Alarm follows Beep Timer (section [012])

Beep Timer For Door Left Open Alarm

VHFWIRQ ^345 `

Enter any value between 001 and 255 to determine the number of seconds the Access Alarm will beep. *Default = 5 seconds.*

Door Forced Open Access Alarm

VHFWIRQ ^339 '=RSWIRQ ^6 `

When the Door Forced Open Alarm is disabled, the following sections are also disabled:

Table 20: Door Forced Open Access Alarm

Section

[004]	Option [7] Door Forced Open Alarm Option [8] Door Forced Open Alarm follows
[013]	Beep Timer for Door Forced Open Alarm

Option [3] OFF=Door Forced Open Alarm is disabled (default)

Option [3] ON=Door Forced Open Alarm is enabled

Door Forced Open Feedback

VHFWIRQ ^337 '=RSWIRQV ^: 'DQG ^; '

Option [7] OFF=Door Forced Open Alarm is silent
Option [7] ON=Door Forced Open Alarm is audible (default)

If option [7] is enabled:
Option [8] OFF=Will beep as long as Door Forced Open Alarm is occurring (default)
Option [8] ON=Door Forced Open Alarm follows Beep Timer. (section [013])

Beep Timer For Door Forced Open Alarm

VHFWIRQ ^346 '

Enter any value between 001 and 255 to determine the number of seconds the Door Forced Open Alarm will beep. *Default = 5 seconds.*

PIN Entry ON Keypad

VHFWIRQ ^339 '=RSWIRQ ^7 '

If the *Card and Code Access* option is enabled in the EVOHD control panel, users must present their access control card and then enter their PIN on the K641R keypad to gain access. The PIN Entry on Keypad option cannot be turned ON and will always be OFF.

Transformer Requirements:	Minimum; 16.5VAC; 40VA	Maximum; 16.5VAC; 75VA
Auxiliary Supply can provide:	typical 600mA Max. 700mA	typical 600mA Max. 700mA
Automatic Shut Down:	1.1A	1.1A
Usable Battery Charge Currents:	350mA	350mA 850mA max.

Index

Numerics

24Hr Zones 12

A

AC Failure not Displayed 34
 AC Power 2
 Access Alarm 39
 Access Card 39
 Access Card Assignment 38
 Access Code Length 37
 Access Codes 37
 Access Control feature 38
 Access Control Terms 39
 Access Denied 39
 Access Granted 39
 Access Level Assignment 38
 Account Number 27
 Account Number Transmission 27
 Activate Card 38
 Add Tolerance Windows to Schedules 38
 Ademco Contact ID 27, 28
 Ademco Express 27, 28
 Ademco slow 27
 Advanced Technology Zoning (ATZ) 12
 Alarm
 On Door Left Open 40
 On Forced Door 40
 Alarm Transmission Delay. See Delay Alarm Transmission
 Alarm Types 14
 Alternate Dialing Option 28
 Always Force Arm 20
 AND Door Access Mode 40
 Answering Machine Override Delay 41
 Arming Follows Partition 19
 Arming with Access Card Skip Exit Delay 40
 Arming/Disarming Reporting 26
 Arming/Disarming Schedule Tolerance Window 27
 Assigning Doors 39
 Assigning keyswitches to partitions 18
 Audible Alarm 23
 Bell Cut-off Timer 22
 Pulsed 14
 Steady 14
 Auto Force on Stay Arming 20
 Auto Report Code Programming 29
 Auto Test Report Period 29
 Auto Trouble Shutdown 34
 Auto Zone Shutdown 13
 Auto Zone Shutdown Limit 13
 Auto-Arming
 Timed 19
 Timer 1 9
 Auto-Arming Options 20
 Automatic Event Buffer Transmission 41
 Automatic report code list 43
 Auxiliary Power 2
 Calculating power consumption 4
 Power Limitations 5
 Power Supply Connections 7
 Away Zones. See Force Zones

B

BabyWare 10
 Answer BabyWare 34, 41
 Call BabyWare 34, 41
 Cancel Communication 34

BabyWare Software 41
 Battery 2
 Battery Test 2
 Bell
 Bell/siren Output 2
 Bell/Siren Output During Fire Alarm 13
 Bell On Communication Fail 30
 Bell Squawk 21
 Bell/Alarm Output 22
 Broadcast 34
 Burglar Alarm 39
 Burglar Alarm on Door Left Open 40
 Burglar Alarm On Forced Door 40
 Burglary Zones 12
 Bus Connection in Noisy Environments 8
 Bus Speed 33
 Busy Tone Detection 30
 Buzzer Zones 12
 Bypass Zones 13

C

Call Back Feature 41
 Call Direction 28
 Cancel Communication 34
 Card and Code Access 40
 Card can Disarm 38
 Card to Unlock and Code to Disarm 38
 Clock Loss
 Access during Clock Loss 40
 Closing Delinquency Timer 29
 Code Access 40
 Code Follows Schedule 38
 Codes
 Special Alarm Report Codes 26
 Special Arming Report Codes 25
 Special Disarming Report Codes 26
 System Trouble Codes 26
 System Trouble Restore Codes 26
 Connecting the Bus in Noisy Environments 8
 Connections
 Bus Connections 8
 Double Zone Connections 8
 Keypad Zone Connections 6
 Keyswitch Connections 2
 Power 2
 Single Zone Connections 7
 Contact ID Pager 28
 Contact ID Report Code List 46

D

Daylight Savings Time 33
 Daylight Savings Time Schedule 33
 Delay Alarm Transmission 14
 Delay Alarm Transmission Timer 14
 Delay Between Dialing Attempts 28
 Delayed 24Hr Fire Zone 13
 Delinquency Timer, Closing 29
 Dial Tone Delay 30
 Disarm Reporting Options 29
 Display "Bypass" If Armed 21
 Door Access Mode 40
 Door Forced Open Restore event 40
 Door Labels 35
 Door Left Open 39
 Doors
 Access During Clock Loss 40

Assigning The Keypad To A Door	39
Burglar Alarm On Door Left Open	40
Burglar Alarm On Forced Door	40
Double Zone Connections	8
Duress	38
E	
Earth Ground	2
Enable Access Control	39
Enable Reporting	25
End #	32
Entry Delay Timer	12
Entry Delay Timers	12
EOL Zones	15
ESL CleanMeTM Installation	8
Event Buffer	
Log Door Forced Open Restore In Event Buffer	40
Log Door Left Open Restore In Event Buffer	40
Log Request For Exit In Event Buffer	40
Event Group	32
Exit Delay	20
Exit Delay cancelled on Remote Arm	21
Exit Delay Termination	20
Extended Unlocked Period	38
F	
Feature Group	32
Feature Select Programming	10
Fire Alarm	23
Fire Circuits	8
Fire Zone	8
Delayed 24Hr	13
Standard 24Hr	13
Follow Zone Switches to Entry Delay 2	20
Force Zones	13
Forced Door	39
Freeze Zones	13
Function Keys, Installer	34
G	
Gas Zones	13
Ground	2
H	
Hardware Reset	33
Heat Zones	13
Hold-up Zones	12
Holiday Programming	39
Hourly Test Transmission	29
I	
Identifier code. See Panel Identifier	41
In-Field Firmware Upgrade	41
Input Numbers	
Keyswitch Numbering 1	8
Input Speed 1	4
Installation Procedure	2
Installer Code	37
Installer Function Keys	34
Installer Lock	33
Installer Test Mode	34
Instant zone	12
Intellizone	14
Intellizone Delay	14
K	
Keypad Beep on Successful Arm/Disarm Report	30
Keypad Installation Instructions	48
Keypad Lockout	21
Keypad Numbering	15
Keypad Zone Connections	6
Keyswitch	
Arm Only	18

Connections	2
Definitions	18
Disabled	18
Keyswitch Numbering	18
Maintained	18
Momentary	18
Options	18
Partition Assignment	18
Stay/Instant Disarm	18
L	
Label Broadcast	34
Label Programming	35
LCD Display	
Shabbat Feature	33
Linked Schedules. See Backup Schedules	
Locate Module	34
Location & Mounting	2
Lock-out	21
Logging Access Control Events	40
M	
Master	38
Maximum Bypass Entries	21
Maximum Dialing Attempts	28
Message Programming. See Label Programming Module	
Broadcast	10, 34
Module Reset	34
Module Scan	34
Module Scanning	34
Multiple Action Feature	34
N	
No AC Fail Display	34
No Bell Cut-Off on Fire Alarm	22
No Exit Delay on Remote Arm	21
No Movement Schedule	20
Noisy Environments	8
O	
One-touch Features	20
OR Door Access Mode	40
P	
Pager Format	27
Pager Reporting Format	28
Panel Partition Assignment	33
Panic Options	23
Partition Labels	35
Partitioning	33
PC Password	41
PC Telephone Number	41
PCB Layout	3
PGM	
PGM Activation Event	32
PGM Deactivation Event	32
PGM Deactivation Option	32
PGM Delay Timers	32
PGM Time Base Selection	32
PGM Initial Status	32
Police Code Timer	22
Postpone Auto-Arming	19
Power Failure Report Delay	28
Power Failure Restore Report Delay	28
Power Save Mode	34
Power Supply Connections	7
Primary Schedule	39
Procedure to Install	2
Programmable Outputs	2
As a 2-wire smoke detector	8
As a 4-wire smoke detector	8
Connections	2

Relay	2, 32
Programming	10
Decimal Programming	10
Feature Select Method	10
Hexadecimal Programming	10
Modules	34
Zone Programming	11
Pulse Dialing	30
Pulse formats. See Standard Pulse Formats	
Pulse Ratio	30
Pulsed Audible Alarm	14
Q	
Quick Module Scanning	34
R	
Reader	39
Recent Close Delay	28
Record REX events	40
Recycle Alarm	22
Recycle Delay	22
Repeat Pager Report Code Transmission	28
Report Code, Repeat Pager	28
Report Only	14
Reporting Formats	27
Request for Exit	39
Reset	
Hardware	33
Module	34
Software	33
Restrict Arming on	
AC Failure	19
Anti Mask Troubles	19
Battery Failure	19
Bell or Auxiliary Failure	19
Door	40
Module Troubles	19
Supervision Loss	19
Tamper	19
TLM Failure	19
Restrict Disarming on Door	40
Ring Counter	41
Ring-back	21
S	
Schedule Assignment	38
Schedule Tolerance Window for Arming/Disarming	27
Schedules	39
Serial Port Baud Rate	33
Serial Port Transmission of Zone Status	33
Sescoa	27
Shabbat Feature	33
SIA FSK.....	27, 28
Silent Alarm	14, 23
Silent Knight fast	27
Sirens	2
Skip Exit Delay When Arming With Card	40
Special Arming Exit Delay	21
Special Characters	35
Special Telephone Number Keys	27
Speed, Bus	33
Standard 24Hr Fire Zone	13
Standard Pulse Formats	28
Start #	32
Stay Zones	13
Supervision Bypass Options	22
Switch To Pulse	30
Switch To Stay Arming	20
System Date and Time	34
System Labels	35
System Master Code	37

T

Tamper Bypass Options	22
Telephone Line Connection Examples.....	9
Telephone Line Connections	9
Telephone Line Monitoring (TLM)	30
Test Report	34
Test reports	29
Timed and Hourly Test Transmission	29
Timed Test Transmission when Armed/Disarmed	29
TLM Fail Timer	30
Tolerance Window	27
Transformer	2
Transmit Zone Status on Serial Port	33

U

User Access Codes	37
User Labels. See Access Codes	
User Menu Access	38
Utility Key	18

V

Valid Card	39
------------------	----

W

Water Zones	13
Wireless Transmitter Supervision Options	22

Z

Zone Labels	35
Zone Restore Report Options	29
Zone Status Transmission to Serial Port	33
Zones	
24Hr Burglary zone	12
24Hr Buzzer	12
24Hr Freeze zone	13
24Hr Gas zone	13
24Hr Heat zone	13
24Hr Hold-up zone	12
24Hr Water zone	13
Alarm Transmission Delay	14
Bypass	13
Connections.....	7
Definition	12
Delayed 24Hr Fire Zone	13
Disabled	12
Doubling	12
EOL	15
Force Zone	13
Generates a report only	14
Intellizone	14
Partition Assignment	13
Pulsed Audible Alarm	14
Silent Alarm	14
Standard 24Hr Fire Zone	13
Stay Zone	13
Steady Audible Alarm	14
Zone Doubling (ATZ)	12
Zone Options	13

Warnings

FCC Warnings. IMPORTANT INFORMATION

This equipment complies with Part 68 of the FCC rules subpart D and CS-03. Inside the cover of this equipment is a label that contains, among other information, the FCC registration number of this equipment.

notification to telephone company

Upon request, customer shall notify telephone company of particular line to which the connection will be made and provide the FCC registration number and the ringer equivalence of the protective circuit.

TELEPHONE CONNECTION REQUIREMENTS

Except for telephone company provided ringers, all connections to the telephone network shall be made through standard plugs and telephone company provided jacks, or equivalent, in such a manner as to allow for easy, immediate disconnection of terminal equipment. Standard jacks shall be so arranged that, if plug connected thereto is withdrawn, no interference to operation of equipment at customer's premises which remains connected to telephone network shall occur by reason of such withdrawal.

INCIDENCE OF HARM

Should terminal equipment/protective circuitry cause harm to telephone network, telephone company shall, where practicable, notify customer that temporary disconnection of service may be required; however, where prior notice is not practicable, the telephone company may temporarily discontinue service if action is deemed reasonable in circumstances. In case of temporary discontinuance, telephone company shall promptly notify customer and will be given opportunity to correct the situation.

CHANGES IN TELEPHONE COMPANY EQUIPMENT OR FACILITIES

The telephone company may make changes in its communication facilities, equipment operations or procedures, where such actions are reasonably required and proper in its business. Should any such changes render customer's terminal equipment incompatible with the telephone company facilities, the customer shall be given adequate notice to effect the modifications to maintain uninterrupted service.

GENERAL

This equipment shall not be used on coin telephone lines. Connection to party line service is subject to state tariffs.

RINGER EQUIVALENCE NUMBER (REN)

The REN is useful to determine the quantity of devices that you may connect to your telephone line and still have all of those devices ring when your telephone number is called. In most, but not all areas, sum of the REN's of all devices connected to one line should not exceed five (5). To be certain of the number of devices that you may connect to your line, you may want to contact your local telephone company.

EQUIPMENT MAINTENANCE FACILITY

If you experience trouble with this telephone equipment, please contact facility indicated below for information on obtaining service or repairs. The telephone company may ask that you disconnect this equipment from network until problem is corrected or until you are sure that the equipment is not malfunctioning.

FCC PART 15, WARNINGS: INFORMATION TO USER

This equipment has been tested and found to comply with the limits for Class B digital devices, pursuant to Part 15 of FCC rules. These limits are designed to provide reasonable protection against harmful interference in a residential installation. This equipment generates, uses and can radiate radio frequency energy, and, if not installed and used in accordance with the instructions, may cause harmful interference to radio communications. However, there is no guarantee that interference will not occur in a particular installation. If this equipment does cause harmful interference to equipment intermittently, the user is encouraged to try to correct the interference by one or more of the following measures: (1) reorient or relocate the receiving antenna; (2) increase the separation between the equipment and receiver; (3) connect the equipment to an outlet on a circuit other than the one to which the receiver is connected, or (4) consult the dealer or an experienced radio/tv technician for assistance.

CAUTION:

Changes or modifications not expressly approved by PARADOX SECURITY SYSTEMS could void the user's authority to operate the equipment.

CTR-21 Warnings. The equipment has been approved in accordance with Council Decision 98/482/EC for pan-European single terminal connection to the public switched telephone network (PSTN). However, due to differences between the individual PSTNs provided in different countries, the approval does not, of itself, give an unconditional assurance of successful operation on every PSTN network termination point. In the event of problems, you should contact your equipment supplier in the first instance.

General Warning. This equipment must be installed and maintained by qualified service personnel only.

Warranty

For complete warranty information on this product please refer to the Limited Warranty Statement found on the website www.paradox.com/terms. Your use of the Paradox product signifies your acceptance of all warranty terms and conditions.

ATTACHMENT LIMITATION NOTICE

The Industry Canada label identifies certified equipment. This certification means that the equipment meets certain telecommunications network protective, operational and safety requirements. The Department does not guarantee the equipment will operate to the user's satisfaction.

Before installing this equipment, users should ensure that it is permissible to be connected to the facilities of the local telecommunications company. The equipment must also be installed using an acceptable method of connection. The customer should be aware that compliance with the above conditions may not prevent degradation of service in some situations.

Repairs to certified equipment should be made by an authorized Canadian maintenance facility designated by the supplier. Any repairs or alterations made by the user to this equipment, or equipment malfunctions, may give the telecommunications company cause to request the user to disconnect the equipment.

Users should ensure for their own protection that the electrical ground connections of the power utility, telephone lines and internal metallic water pipe system, if present, are connected together. This precaution may be particularly important in rural areas.

CAUTION: Users should not attempt to make such connections themselves, but should contact the appropriate electrical inspection authority, or electrician, as appropriate.

The Load Number (LN) assigned to each terminal device denotes the percentage of the total load to be connected to a telephone loop which is used by the device to prevent overloading. The termination on a loop may consist of any combination of devices subject only to the requirement that the total of the Load Numbers of all of the devices does not exceed 100.

Industry Canada certification is only applicable to installation of devices which include transformers approved by the Canadian Standards Association (CSA).
© 2002-2013 Paradox Ltd. Digiplex EVOHD, BabyWare, Magellan, NEware and InTouch are trademarks or registered trademarks of Paradox Ltd. and its affiliates in Canada, the United States and/or other countries. All rights reserved.

Additional Considerations. Annual verification of timing of an alarm and a fault message is required. ATS5 requirements is the arithmetic mean of all transmissions is less than or equal to 20 seconds and 95% of all transmissions are less than or equal to 30 seconds. Time is measure from the moment the message is reported on a local keypad to when the monitoring station receiver successfully receives the message. This can be accomplished by contacting the monitoring station and sending a test message and calculating the time from which the message appears on the local keypad and when the monitoring station receives the same message. As with traditional land-line reporting an acknowledgement (kiss-off) signal is used when the IP150 or PCS250 sends a valid message to a receiver that is typically used in a monitoring station. This acknowledgement is generated within 5 seconds. Discuss with your service provider the different options that are available for monitoring; for example, the frequency of supervision. The transmission of an alarm message may be negatively affected by a variety of factors. These may include disruptions in 3rd party services like internet access and GSM service. If after a set amount of transmission attempt are unsuccessful local and remote messages are generated. Standard set of commonly available hand tool are require to install equipment; no equipment adjustments are necessary. When configured as indicated the IP150 / PCS250 surpass the ATS5 performance criteria set out in EN 50131-1; the on board dialer surpasses ATS 2 performance criteria. The period from the time a fault develops in the alarm transmission system until the fault information is reported to the alarm receiving centre and/or monitoring centre shall not exceed 180 seconds for ATS 5, and 25 hours for ATS 2 performance criteria as defined by EN 50131-1. This is achieved through settings in the Security Profile of each account at the receiver Equipment or settings the Auto Test Report to run every 24 hours. Refer to receiver instruction documentation for further information. As required per clause 7.5 of EN 50136-1-1, records of all faults and of all performance verifications carried out on the alarm transmission system shall be maintained. Requirements include the availability of these records for inspection, and availability analysis calculations based on these records. Consult the standard for more detailed information.



P ▲ R ▲ D O X™

The whole Paradox team wishes you a successful and easy installation.
We hope this product performs to your complete satisfaction.
Should you have any questions or comments, please contact us.

For support, please contact your local distributor, or dial +1-450-491-7444,
Monday to Friday, from 8:00 a.m. to 5:00 p.m. EST.
You may also e-mail us at support@paradox.com.
Additional information can be found at PARADOX.COM

EVOHD-EI02

Printed in Canada



www.paradox.com